

CATÁLOGO GENERAL

GENERAL CATALOGUE

CATALOGUE GÉNÉRAL



CILINDRO S.A.

INTRODUCCIÓN

Coincidiendo con el 20 Aniversario de CILINDRO, S.A., empresa fundada en 1986, sale a la luz este catálogo en el que hemos conjugado experiencia, diseño y una gran ilusión.

Todo ello, unido a nuestro afán constante de superación, ha dado como resultado estas páginas llenas de novedades, de piezas de gran calidad, con carácter, actuales, capaces de aportar soluciones a las demandas más exigentes del mercado, garantizando así el mejor servicio a nuestros clientes.

Los que formamos parte de esta empresa, agradecemos la confianza y fidelidad de aquellos que nos han acompañado durante todo este tiempo y damos la bienvenida a quienes llegan por primera vez, deseando que nuestra relación sea duradera.

INTRODUCTION

This catalogue coincides with the 20th Anniversary of CILINDRO, S.A., the company was founded in 1986; the contents of these pages are a combination of experience, design and enthusiasm.

In honor of this special occasion, along with our constant quest for improvement, we have produced a catalogue, which is full of novelties, high quality pieces with character, up-to-the-minute, that offer solutions to the most exacting demands of the market, thus guaranteeing optimum service to our clients.

On behalf of all of us at CILINDRO, S.A., we would like to express our gratitude for the trust and loyalty of those who have accompanied us over the last 20 years; we also want to welcome those who are with us for the first time and hope that our relationship will be a lasting one.

INTRODUCTION

Ce catalogue, où nous avons conjugués expérience, design et un grand enthousiasme, voit le jour en coïncidant avec le 20 Anniversaire de CILINDRO, S.A., entreprise fondée en 1986.

Tout ceci, uni à l'effort constant de surpassement, donne comme résultat ces pages pleines de nouveautés, de pièces de grandes qualités, avec un caractère actuel, capables d'apporter des solutions aux demandes les plus exigeantes du marché, garantissant ainsi le meilleur service possible à nos clients.

Les personnes composant notre entreprises, remercie la confiance et la fidélité de tout ceux qui nous ont accompagnés pendant toutes ces années et nous souhaitons la bienvenue à tous nos nouveaux clients en espérant une longue collaboration entre nous.

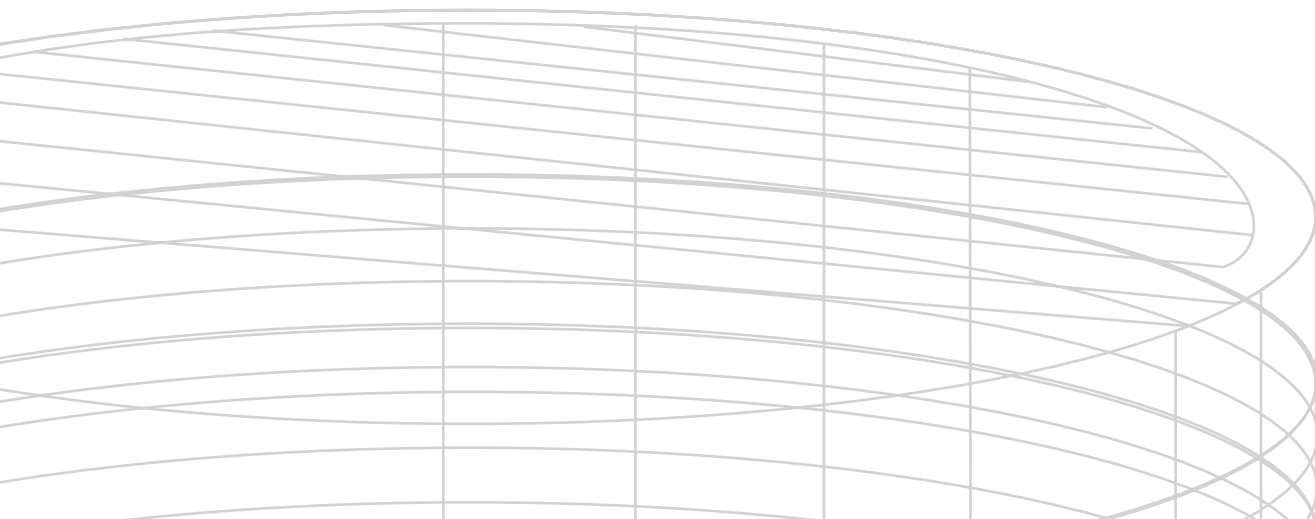



Innovación, Calidad, Diseño
Innovation,



PAPELERAS

WASTE PAPER BIN

CORBEILLES À PAPIER

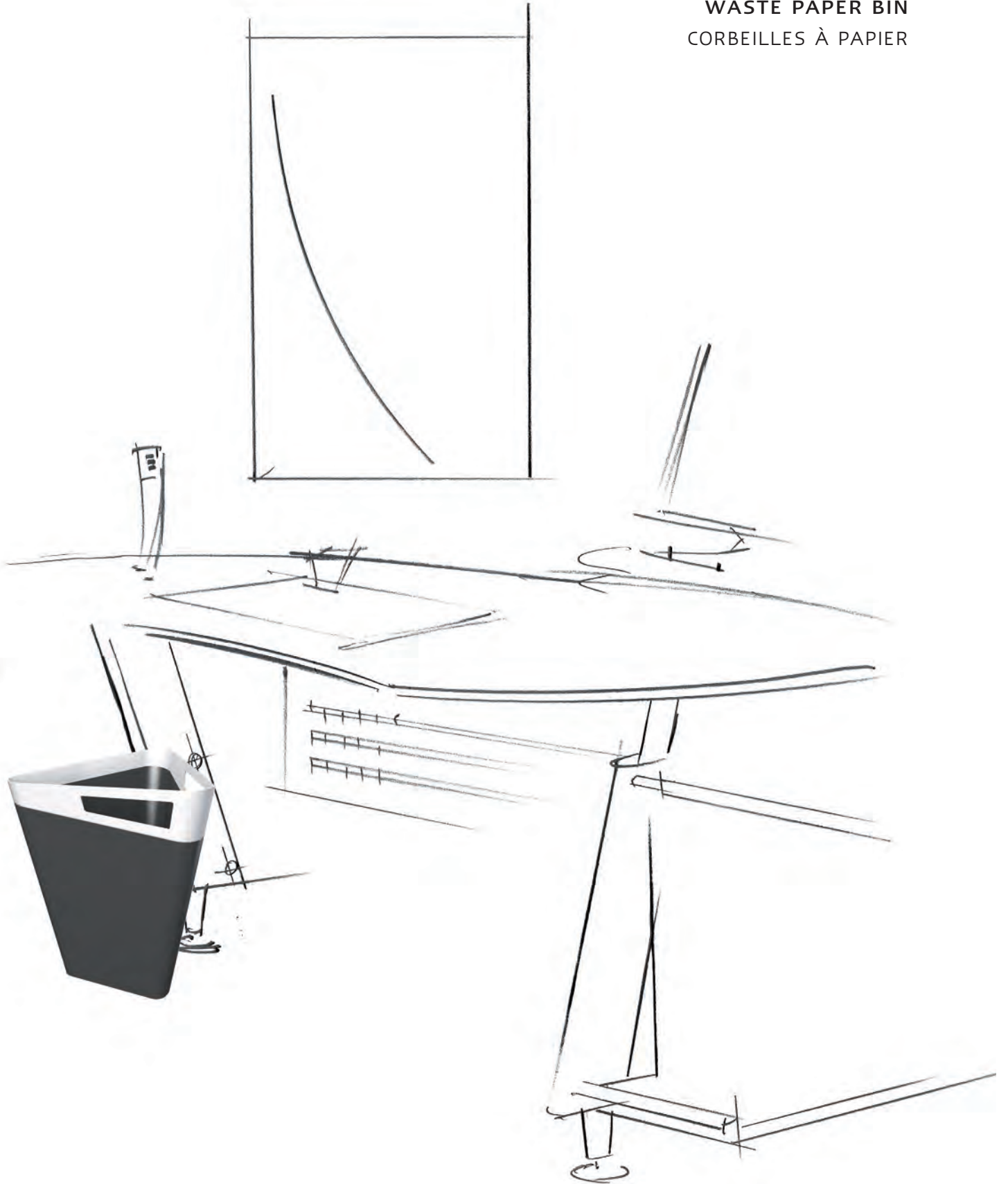

P-41

Papelera metálica. Embellecedores en negro.
Colores: negro, grafito, azul, burdeos,
RAL 9006.

Metal waste-paper bin. Black trims.
Colours: black, graphite (dark gray), blue, burgundy,
RAL 9006.

Corbeille à papier métallique. Enjoliveurs en noir.
Couleurs: noir, graphite, bleu, bordeaux, RAL 9006.

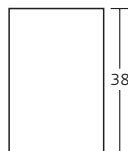

P-21

Papelera metálica con dos asas.
Colores: negro, grafito, azul, burdeos,
RAL 9006.

Metal waste-paper bin with two handles.
Colours: black, graphite (dark gray), blue, burgundy,
RAL 9006.

Corbeille à papier métallique à deux anses.
Couleurs: noir, graphite, bleu, bordeaux, RAL 9006.

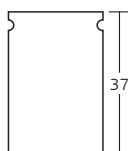

P-43

Papelera metálica con asa.
Embellecedores en negro.
Colores: negro, grafito, azul, burdeos,
RAL 9006.

Metal waste-paper bin with handle. Black trims.
Colours: black, graphite (dark gray), blue, burgundy,
RAL 9006.

Corbeille à papier métallique à anse. Enjoliveur en noir.
Couleurs: noir, graphite, bleu, bordeaux, RAL 9006.

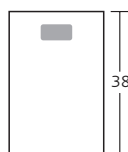

P-40

Papelera metálica. Embellecedores en negro.
Colores: negro, grafito, azul, burdeos,
RAL 9006.

Metal waste-paper bin. Black trims.
Colours: black, graphite (dark gray), blue, burgundy,
RAL 9006.

Corbeille à papier, métallique. Enjoliveurs en noir.
Couleurs: noir, graphite, bleu, bordeaux, RAL 9006.

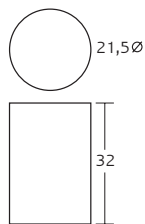

P-10

Papelera metálica con dos asas.
Embellecedor base en negro.
Colores: negro, grafito, azul, burdeos,
RAL 9006.

Metal waste-paper bin with two handles.
Base black trim.
Colours: black, graphite (dark gray), blue, burgundy,
RAL 9006.

Corbeille à papier métallique à deux anses.
Enjoliveur base en noir.
Couleurs: noir, graphite, bleu, bordeaux, RAL 9006.

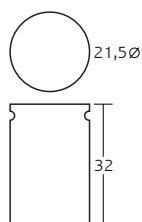

P-42

Papelera metálica con asa.
Embellecedores en negro.
Colores: negro, grafito, azul, burdeos,
RAL 9006.

Metal waste-paper bin with handle. Black trims.
Colours: black, graphite (dark gray), blue, burgundy,
RAL 9006.

Corbeille à papier métallique à anse. Enjoliveurs en noir.
Couleurs: noir, graphite, bleu, bordeaux, RAL 9006.

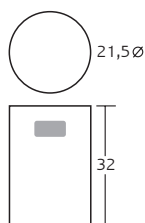

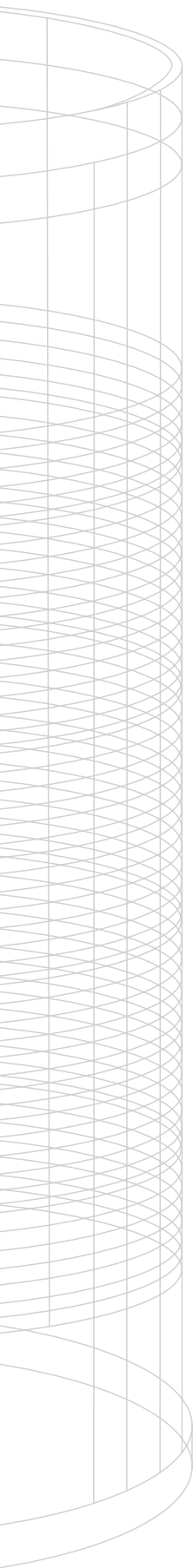

P-00

Papelera metalica selectiva de residuos.
Cubetas extraibles para su vaciado. Bastidor
metalico. Embellecedor base en negro.
Colores: Bastidor: RAL 9006.
Cubetas: Amarillo y Azul.

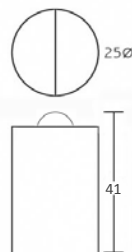

P-01

Papelera metalica selectiva de residuos
con cubeta extraible para su vaciado.
Embellecedor base en negro.
Colores Papelera: Negro, RAL 9006
Colores Cubeta: Amarillo, Azul.

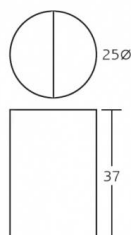

P-02

Papelera metalica selectiva de residuos.
Cubetas extraibles para su vaciado.
Embellecedor base en negro.
Colores Cubetas: Amarillo y Azul.

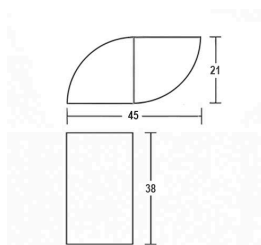

P-45



21,5 Ø

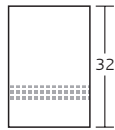

32

Papelera inoxidable perforada.
Embelledor base en negro.

Perforated stainless wastepaper basket.
Black trim on base.

Corbeille à papier inoxydable perforée.
Enjoliveur base noir.

P-46

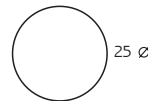

25 Ø

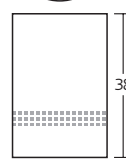

38

Papelera inoxidable perforada.
Embelledor base en negro.

Perforated stainless wastepaper basket.
Black trim on base.

Corbeille à papier inoxydable perforée.
Enjoliveur base noir.

P-47

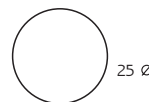

25 Ø

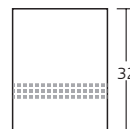

32

Papelera inoxidable perforada.
Embelledor base en negro.

Stainless mesh waste basket.
Base trimmed in black.

Corbeille à papier en inoxydable.
Enjoliveur base noir.



P-46



P-45



P-47

P-18

Papelera metálica forrada vinilo. Aros cromados.
Colores: negro, marrón.

Metal waste-paper bin vinyl lined. Chromed rings.
Colours: black, brown.

Corbeille à papier métallique à doublure en vinyle
et à cerceaux chromés.
Couleurs: noir, brun.

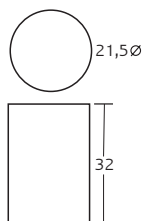

P-33

Papelera metálica forrada vinilo.
Aros cromados.
Colores: negro, marrón.

Metal waste-paper bin vinyl lined.
Chromed rings.
Colours: black, brown.

Corbeille à papier métallique à doublure en vinyle
et à cerceaux chromés.
Couleurs: noir, brun.

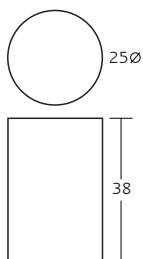

P-22

Papelera metálica con asa.
Embellecedor en negro
Colores: negro, RAL 94514171

Metal waste-paper bin with handle. Black trim.
Colours: black, RAL 9006.

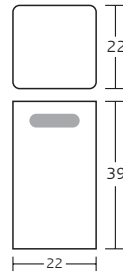

P-13

Papelera metálica con asa.
Embellecedor en negro.
Colores: negro, RAL 9006.

Metal waste-paper bin with handle. Black trim.
Colours: black, RAL 9006.

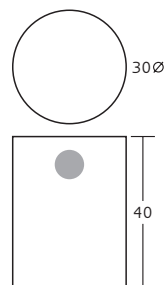

P-14

Papelera metálica. Remate superior desmontable para sujeción de bolsas. Embellecedor base en negro.

**Colores: negro con remate RAL 9006.
RAL 9006 con remate negro.**

Metal waste basket.
Removable upper rim for placing trash bags.
Base trimmed in black.

Colours: black with RAL 9006 rim.
RAL 9006 with black rim.

Corbeille à papier métallique. Pièce supérieure démontable pour la fixation de sacs.

Enjoliveur en noir.

Couleurs: noir avec dessus RAL 9006.
RAL 9006 avec dessus noir.

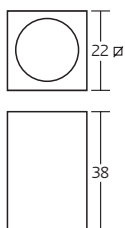

P-15

Papelera metálica. Remate superior desmontable para sujeción de bolsas. Embellecedor base en negro.

**Colores: negro con remate RAL 9006.
RAL 9006 con remate negro.**

Metal waste basket. Removable upper rim for placing trash bags. Base trimmed in black.

Colours: black with RAL 9006 rim.
RAL 9006 with black rim.

Corbeille à papier métallique. Pièce supérieure démontable pour la fixation de sacs.

Enjoliveur en noir.

Couleurs: noir avec dessus RAL 9006.
RAL 9006 avec dessus noir.

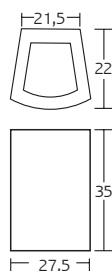

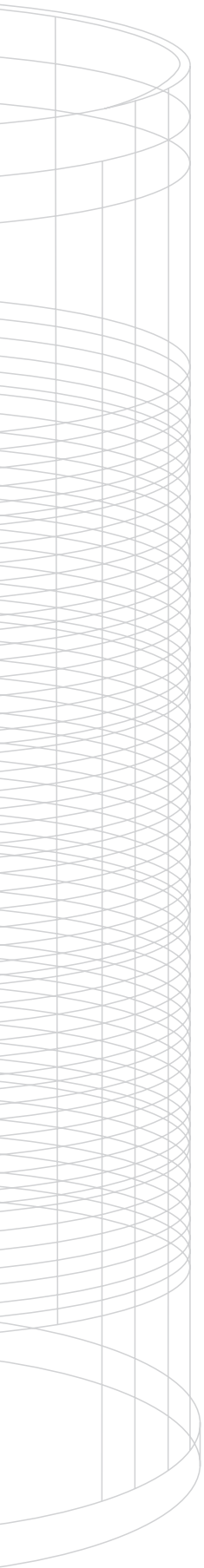

P-30

**Papelera-cenicero metálico de pared.
Papelera abatible para su descarga.
Soporte y cenicero pintados en negro.
Colores: negro, burdeos, RAL 9006.**

**Metal wall waster-paper bin-ashtray.
Folding waster-paper bin to empty.
Stand and ashtray black painted.
Colours: black, burgundy, RAL 9006.**

Corbeille à papier-cendrier, métallique, murale.
Corbeille à papier rabattable pour la vider.
Support et cendrier peints en noir.
Couleurs: noir, bordeaux, RAL 9006.

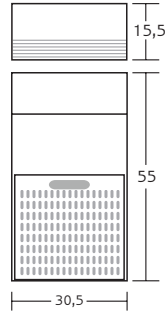

P-28

**Papelera metálica de pared.
Colores: negro, burdeos, RAL 9006.**

**Metal wall waste-paper bin.
Colours: black, burgundy, RAL 9006.**

Corbeille à papier, métallique murale.
Couleurs: noir, bordeaux, RAL 9006.

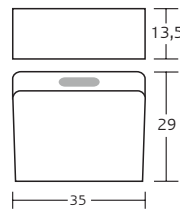

P-37

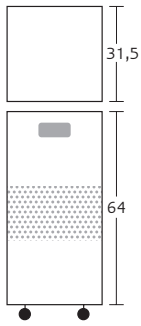

Papelera metálica con ruedas. Dos asas.
Cerquillo superior desmontable para sujeción de bolsas.
Colores: negro, grafito, RAL 9006.

Wheeled metal waste-paper bin. Two handles.
Top trim can be removed to hold bags.
Colours: black, graphite (dark gray), RAL 9006.

Corbeille à métallique sur roues. Deux anses.
Cerceau supérieur démontable pour la fixation de sacs.
Couleurs: noir, graphite, RAL 9006.

P-38

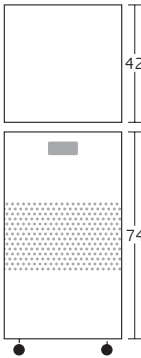

Papelera metálica con ruedas. Dos asas.
Cerquillo superior desmontable para sujeción de bolsas. Colores: negro, grafito, RAL 9006.

Wheeled metal waste-paper bin. Two handles. Top trim can be removed to hold bags. Colours: black, graphite (dark gray), RAL 9006.

Corbeille à papier métallique sur roues. Deux anses. Cerceau supérieur démontable pour la fixation de sacs. Couleurs: noir, graphite, RAL 9006.



P-37



P-38

P-26

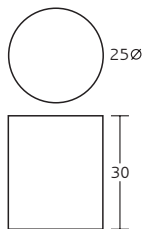

**Papelera metálica aluminio pulido.
Aro aluminio pulido.**

**Polished aluminium waste-paper bin.
Polished aluminium ring.**

**Corbeille à papier en aluminium poli.
Cerceau en aluminium poli.**

P-25

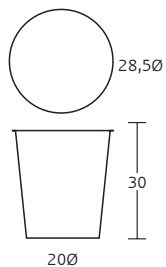

Papelera cónica aluminio pulido.

Conic-shaped polished aluminum waste basket.

Corbeille à papier conique en aluminium poli.



P-26



P-25

ALUMINIO PULIDO



**V-40 A JUEGO PORTALAPICEROS.
MATCHING PENCIL HOLDER.
IL VA ENSEMBLE AVEC LE PORTE-CRAYONS.**

P-50

Papelera ABS con aro en negro.
Colores: negro, plata.

ABS waste-paper bin with black ring.
Colours: black, red, white.

Corbeille à papier ABS avec cerceau en noir.
Couleurs: noir, rouge, blanc.

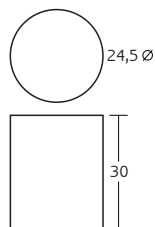

ABS



P-51

Papelera ABS.
Colores: negro, plata.

ABS Waste-paper bin.
Colours: black, red, white.

Corbeille à papier ABS.
Couleurs: noir, rouge, blanc.

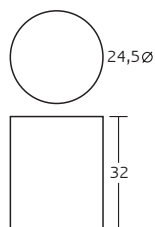

ABS



P-52

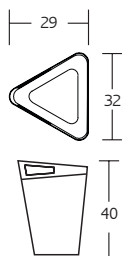

Papelera ABS con remate superior.

Colores: negro con remate plata.

Plata con remate negro.

ABS waste basket with upper rim.

Colours: black with silver rim.

Silver with black rim.

Corbeille à papier ABS avec enjoliveur supérieur.

Couleurs: noir avec dessus argent.

Argent avec dessus noir.

ABS



V-81 A JUEGO PORTALAPICEROS.

MATCHING PENCIL HOLDER.

IL VA ENSEMBLE AVEC LE PORTE-CRAYONS.

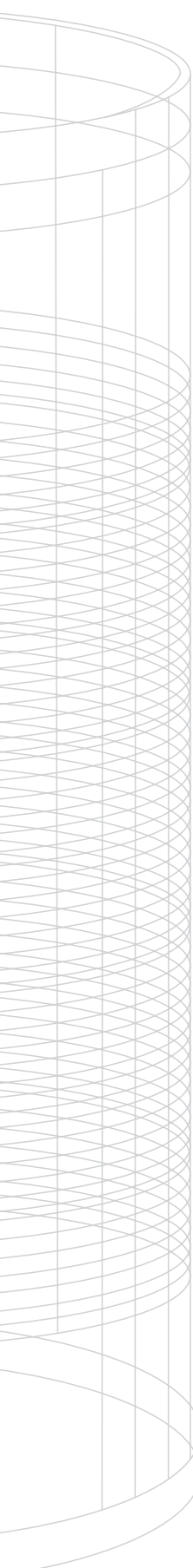

P-23

Papelera metálica perforada.
Embellecedor en negro.
Colores: negro, grafito, RAL 9006.

Perforated metal waste-paper bin. Black trim.
Colours: black, graphite (dark gray), RAL 9006.

Corbeille à papier métallique perforée. Enjoliveur en noir.
Couleurs: noir, graphite, RAL 9006.

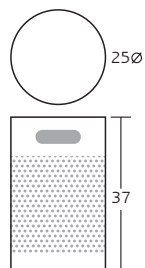

P-19

Papelera metálica rejilla. Aros cromados.
Colores: negro, grafito, RAL 9006.

Mesh metal waste-paper bin. Chromed rings.
Colours: black, graphite (dark gray), RAL 9006.

Corbeille à papier métallique grillage. Cerceaux chromés.
Couleurs: noir, graphite, RAL 9006.

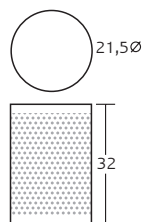

P-34

Papelera metálica perforada.
Embellecedores en negro.
Colores: negro, RAL 9006.

Perforated metal waste-paper bin.
Black trims.
Colours: black, RAL 9006.

Corbeille à papier métallique perforée.
Enjoliveurs en noir.
Couleurs: noir, RAL 9006.

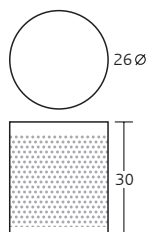

P-32

Papelera metálica ovalada.
Embellecedor en negro.
Colores: negro, RAL 9006.

Oval metal waste-paper bin.
Black trim.
Colours: black, RAL 9006.

Corbeille à papier métallique ovale.
Enjoliveur en noir.
Couleurs: noir, RAL 9006.

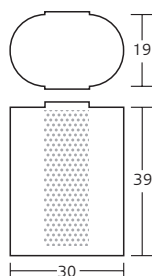

The image features a detailed architectural sketch of a building's interior. The drawing uses various line weights and styles to create a sense of depth and structure. In the foreground, a cylindrical paper recycling bin is rendered with a solid grey color and a black top and bottom. The bin has a decorative band of small dots near its base. The background consists of a complex network of lines representing walls, floors, and ceiling structures. On the right side, there are two rectangular openings with horizontal slats, possibly representing a staircase or a ventilation system. The overall style is that of a technical or conceptual architectural drawing.

PAPELERAS ZONAS COMUNES Y RECICLAJE

RECYCLE AND COMMON AREAS WASTE PAPER BINS

CORBÉILLES À PAPIER POUR ZONNES COMMUNES ET RECYCLAGE

P-71

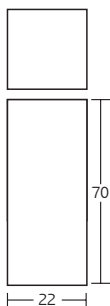

Papelera metálica. Remate superior desmontable para sujeción de bolsas. Embellecedor base en negro. Colores: negro con remate RAL 9006. RAL 9006 con remate negro.

Metal waste basket. Removable upper rim for placing trash bags. Base trimmed in black. Colours: black with rim RAL 9006. RAL 9006 with black rim.

Corbeille à papier métallique pièce supérieure démontable pour la fixation de sacs. Enjoliveur base en noir. Couleurs: noir avec dessus RAL 9006. RAL 9006 avec dessus noir.



P-70

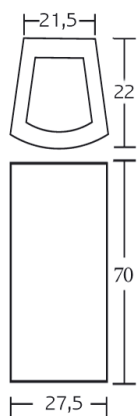

Papelera metálica. Remate superior desmontable para sujeción de bolsas. Embellecedor base en negro. Colores: negro con remate RAL 9006. RAL 9006 con remate negro.

Metal waste basket. Removable upper rim for placing trash bags. Base trimmed in black. Colours: black with rim RAL 9006. RAL 9006 with black rim.

Corbeille à papier métallique pièce supérieure démontable pour la fixation de sacs.
Enjoliveur base en noir.
Couleurs: noir avec dessus RAL 9006.
RAL 9006 avec dessus noir.



P-75

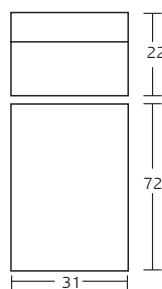

Papelera metálica con tapa abatible. Papelera con asa extraíble para su vaciado. Embellecedores en negro. Colores: negro, grafito, azul, burdeos, RAL 9006.

Metal waste basket with swing lid. Waste basket with removable handle for emptying. Base trimmed in black. Colours: black, graphite (dark gray), blue, burgundy, RAL 9006.

Corbeille à papier métallique. Baquet extractible avec anse. Enjoliveurs en noir.
Couleurs: noir, graphite, bleu, bordeaux, RAL 9006.



P-73

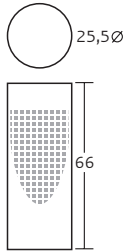

Papelera inoxidable perforada. Remate superior cromado, desmontable para sujeción de bolsas. Embellecedor base en negro.

Stainless mesh waste basket. Chrome upper rim, removable for placing trash bags. Base trimmed in black.

Corbeille à papier en inoxydable perforée.
Pièce supérieure démontable pour la fixation de sacs.
Enjoliveur base en noir.

P-74

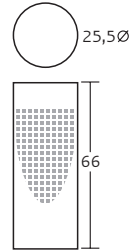

Papelera metálica perforada. Remate superior cromado, desmontable para sujeción de bolsas. Embellecedor base en negro.

Colores: negro, grafito, azul, burdeos, RAL 9006.

Metal mesh waste basket. Chrome upper rim, removable for placing trash bags.

Base trimmed in black.

Colours: black, graphite (dark gray), blue, burgundy, RAL 9006.

Corbeille à papier métallique pièce supérieure démontable pour la fixation de sacs.

Enjoliveur base en noir.

Colours: noir, graphite, bleu, bordeaux,



P-76

Papelera metálica basculante. Parte superior desmontable para sujeción de bolsas. Embellecedor en base. Colores: negro, RAL 9006.

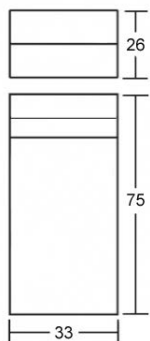

P-90

Papelera metálica. Remate superior cromado. Embellecedores en abertura y base. Colores: Negro, Grafito, Azul, Burdeos, RAL 9006.

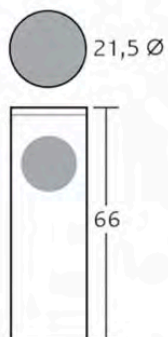

P-80

Papelera metálica selectiva de residuos.
Cubetas extraíbles para su vaciado.
Embellecedor base en negro. Colores
Cubetas: Amarillo y Azul

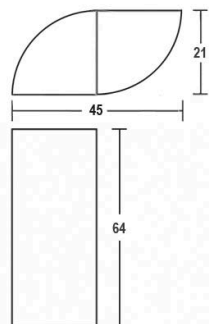

P-72

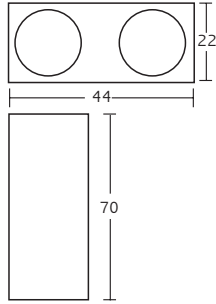

Papelera metálica selectiva de residuos con remate superior desmontable. Dos cubetas interiores extraíbles para su vaciado. Embellecedor base en negro. Colores: negro con remate RAL 9006. RAL 9006 con remate negro.

Metal waste basket with compartments for sorting waste materials with removable upper rim. Two removable bins for emptying. Base trimmed in black. Colours: black with rim RAL 9006, RAL 9006 with black rim.

Corbeille à papier métallique pour recycler les déchets pièce supérieure e démontable avec baquets extractibles. Enjoliveur base en noir. Couleurs: noir avec dessus RAL 9006. RAL 9006 avec dessus noir.

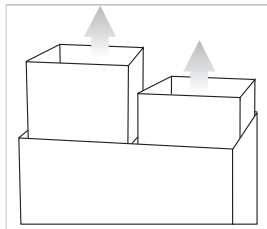

P-77

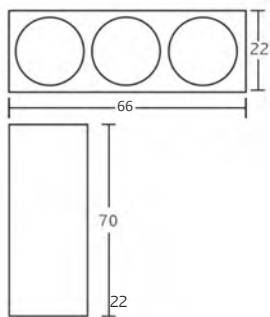

Papelera metálica selectiva de residuos con remate superior desmontable. Tres cubetas interiores extraíbles para su vaciado. Embellecedor base en negro. Colores: negro con remate RAL 9006. RAL 9006 con remate negro.

Metal waste basket with compartments for sorting waste materials with removable upper rim. Three removable bins for emptying. Base trimmed in black. Colours: black with rim RAL 9006, RAL 9006 with black rim.



P-81

Papelera metalica selectiva de residuos.
Dos cubetas extraibles para su vaciado.
Bastidor metalico. Embellecedor base en negro.
Colores: Bastidor: Negro, RAL 9006. Cubetas: Amarillo y Azul.

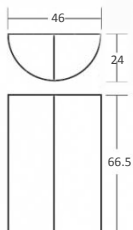

P-82

Papelera metalica selectiva de residuos.
Dos cubetas extraibles para su vaciado.
Bastidor metalico. Embellecedor base en negro.
Colores: Bastidor: Negro, RAL 9006. Cubetas: Amarillo y Azul.

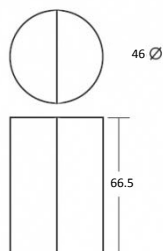

P-83

Papelera metalica selectiva de residuos.
Tres cubetas extraibles para su vaciado.
Bastidor metalico. Embellecedor base en negro.
Colores: Bastidor: Negro, RAL 9006. Cubetas: Amarillo, Azul y Verde.

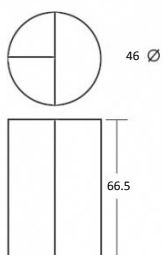

P-84

Papelera metalica selectiva de residuos.
Cuatro cubetas extraibles para su vaciado.
Bastidor metalico. Embellecedor base en negro.
Colores: Bastidor: Negro, RAL 9006. Cubetas: Amarillo, Azul, Verde y Marron.

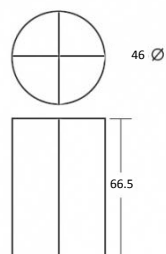

P-94

Papelera metálica. Tapa pintada en negro. Embellecedores negros en abertura y base. Enganches interiores para bolsa de basura. Colores: Negro, Grafito, RAL 9006.

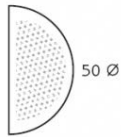

P-92

Papelera metalica. Tapa pintada en negro. Embellecedores negros en abertura y base. Cubeta interior para su descarga. Colores: Negro, Grafito, RAL 9006.

P-93

Papelera inoxidable. Tapa pintada en negro. Embellecedores negros en abertura y base. Cubeta interior para su descarga.

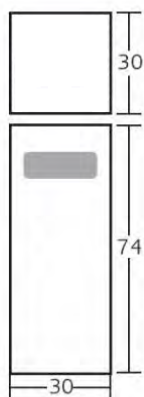

P-92/93

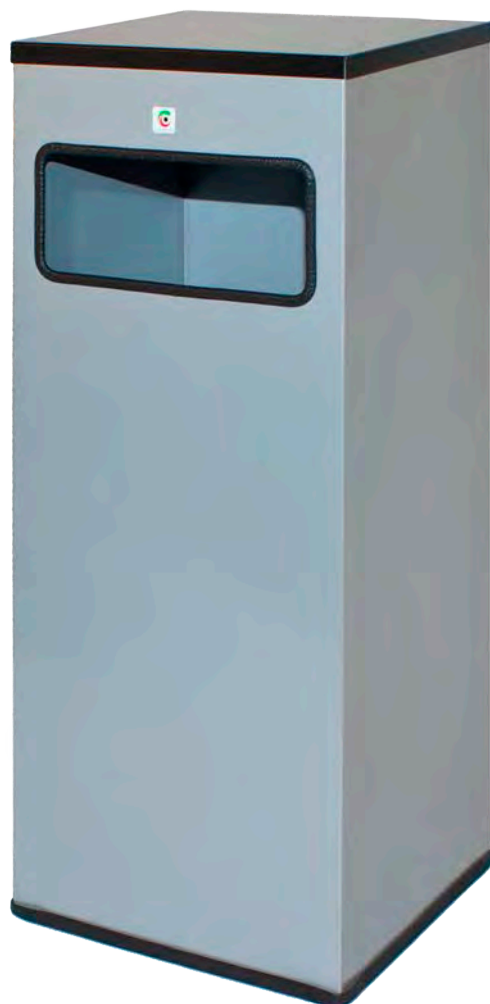

CENICERO PAPELERAS EXTERIOR
LITTER WASTE PAPER BINS-ASHTRAYS
CENDRIER-CORBÉILLES EXTÉRIEURES



*P-60

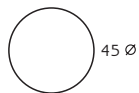

**Papelera metálica perforada con soporte.
Sistema basculante.
Colores: grafito, verde.**

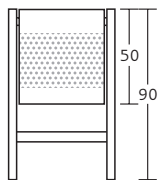

Perforated metal litter-bin with stand.
Swivel system.
Colours: graphite (dark gray), green.

Corbeille à papier, métallique, perforée à support. Système basculant.
Couleurs: graphite, vert.



** cualquiera de estos modelos de papelera de exterior se puede suministrar con cenicero. ej. pag. 40*

*P-61

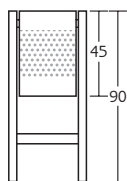

**Papelera metálica perforada con soporte.
Sistema basculante.
Colores: grafito, verde.**

**Perforated metal litter-bin with stand.
Swivel system.
Colours: graphite (dark gray), green.**

Corbeille à papier, métallique, perforée à support.
Système basculant.
Couleurs: graphite, vert.



** cualquiera de estos modelos de papelera de exterior se puede suministrar con cenicero. ej. pag. 40*

*P-63



Papelera metálica perforada de pared.
Sistema basculante.
Colores: grafito, verde.

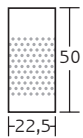

Perforated metal wall litter-bin.
Swivel system.
Colours: graphite (dark gray), green.

Corbeille à papier, métallique, perforée murale.
Système basculant.
Couleurs: graphite, vert.

*P-62

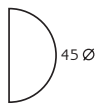

Papelera metálica perforada con soporte.
Sistema basculante.
Colores: grafito, verde.

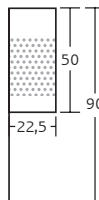

Perforated metal litter-bin with stand. Swivel system.
Colours: graphite (dark gray), green.

Corbeille à papier, métallique, perforée à support.
Système basculant.
Couleurs: graphite, vert.



** cualquiera de estos modelos de papelera de exterior se puede suministrar con cenicero. ej. pag. 40*

*P-64

Papelera metálica con soporte.
Sistema basculante.
Colores: grafito, verde.

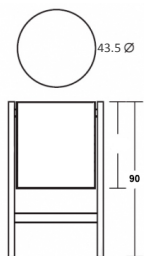

*P-65

Papelera metálica con soporte.
Sistema basculante.
Colores: grafito, verde.

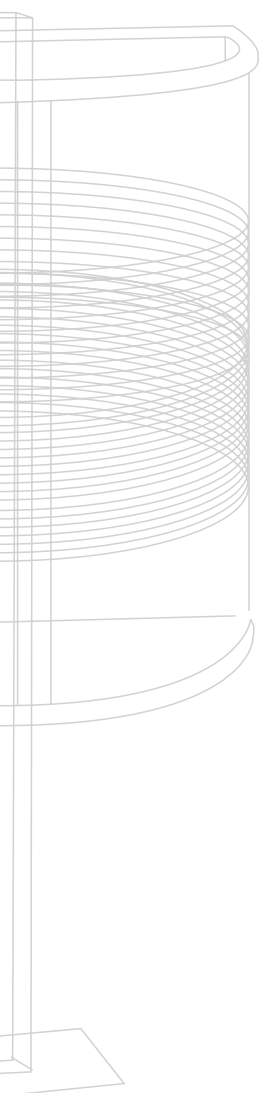
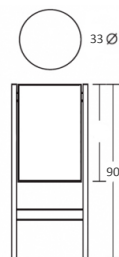

** cualquiera de estos modelos de papelera de exterior se puede suministrar con cenicero. ej. pag. 40*

*P-66

Papelera metálica con soporte.
Sistema basculante.
Colores: grafito, verde.

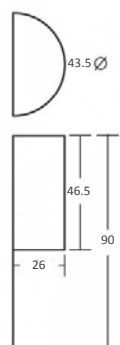

*P-67

Papelera metálica de pared.
Sistema basculante.
Colores: grafito, verde.



** cualquiera de estos modelos de papelera de exterior se puede suministrar con cenicero. ej. pag. 40*



Ejemplos de papeleras de exterior con cenicero incorporado

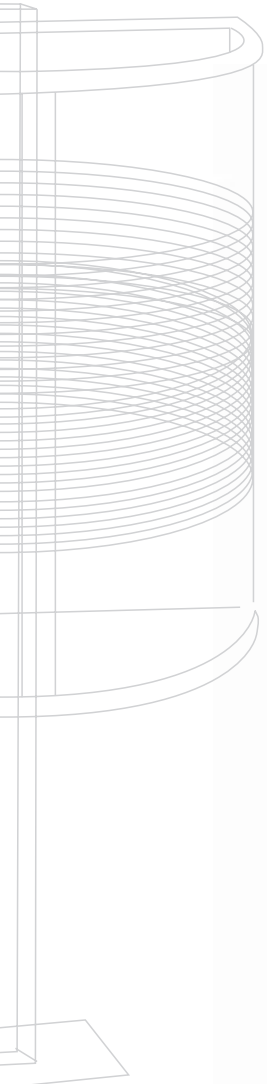

P-68

Papelera metálica para postes y farolas

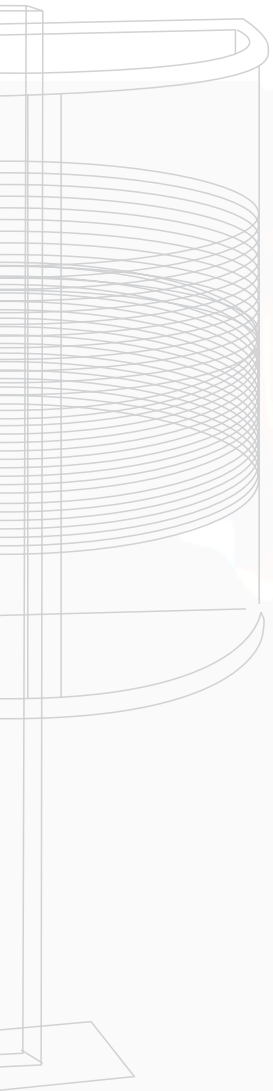
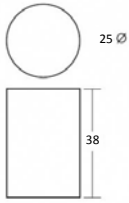

PAPELERAS DE PEDAL

PEDAL BINS

COUBELLE À PÉDALE



P-55

Papelera de pedal Inoxidable.
Embellecedor base en negro. Cesto interior
en plástico negro, con asa metálica para su
extracción.

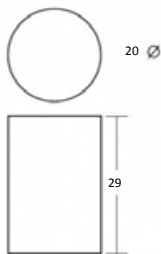

P-56

Papelera de pedal Inoxidable.
Embellecedor base en negro. Cesto interior
en plástico negro, con asa metálica para su
extracción.

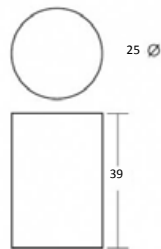

PAPELERAS CENICERO
WASTE PAPER BIN-ASHTRAYS
CORBÉILLES À PAPIER-CENDRIERS



B-13

**Papelera-cenicero inoxidable perforado.
Recogecolillas pintado en negro. Rejilla cromada.
Embellecedor base en negro.**

Metal waste-paper bin-ashtray. Perforated stainless steel. Cigarettes but-holder black painted. Chromed mesh. Black trim around base.

Corbeille à papier-cendrier, inoxydable perforé.
Ramasse-mégots peint en noir. Grille chromée.
Enjolivieur à la base en noir.

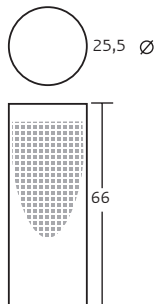

B-57

**Papelera-cenicero inoxidable.
Recogecolillas pintado en negro.
Rejilla cromada. Embellecedores
en negro. Cubeta interior para su
vaciado.**

**Stainless ashtray/wastepaper basket.
Tray painted black. Chromed grate. Black
trim. Inner receptacle for emptying.**

Corbeille à papier-cendrier inoxydable.
Recueille-mégots peint en noir. Grille
chromée. Enjoliveurs noirs. Récipient
intérieur de vidange.

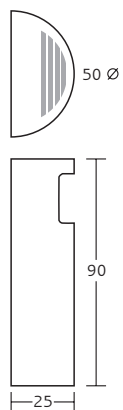

B-58

**Papelera-cenicero inoxidable.
Recogecolillas pintado en negro.
Rejilla cromada.
Embellecedores en negro. Cubeta
interior para su vaciado.**

Stainless ashtray/wastepaper basket.
Tray painted black. Chromed grate.
Black trim. Inner receptacle for emptying.

Corbeille à papier-cendrier, inoxydable.
Recueille-mégots peint en noir. Grille
chromée. Enjoliveurs noirs. Récipient intérieur
de vidange.

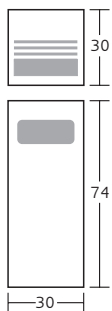

B-17

Papelera-cenicero metálico.
Recogecolillas pintado en negro. Rejilla cromada.
Embellecedores en abertura y base. Cubeta interior para su descarga.

Colores: negro, grafito, RAL 9006.

Metal waste-paper bin-ashtray.
Cigarettes butt-holder black-painted.
Chromed mesh. Trims around opening and base. Inside bucket can be emptied.
Colours: black, graphite (dark gray),
RAL 9006.

Corbeille à papier-cendrier. Ramasse-mégots
peint en noir. Grille chromée. Enjoliveurs sur
ouverture et base. Cuvette intérieure pour
le vidage.
Couleurs: noir, graphite, RAL 9006.

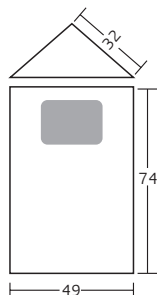

B-56

Papelera-cenicero metálico.
Recogecolillas pintado en negro.
Embellecedor en negro. Enganches interiores para bolsa de basura.
Colores: negro, grafito, RAL 9006.

Metal bin ashtray. Cigarettes buttholder black painted. Black trims. Interior hooks for liner bag.
Colours: black, graphite (dark gray), RAL 9006.

Corbeille à papier-cendrier métallique.
Ramasse-mégots peint en noir. Enjoliveur en noir. Crochets intérieurs pour sac à ordures.
Couleurs: noir, graphite, RAL 9006.

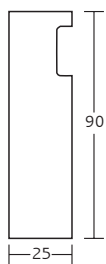
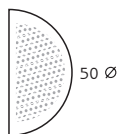

B-16

Papelera-cenicero metálico.
Recogecolillas pintado en negro.
Rejilla cromada. Embellecedores en
abertura y base. Cubeta interior para
su descarga.
Colores: negro, grafito, RAL 9006.

Metal waste-paper bin-ashtray.
Cigarettes butt-holder black painted.
Chromed mesh. Trims around opening and
base. Inside bucket can be emptied.
Colours: black, graphite (dark gray),
RAL 9006.

Corbeille à papier-cendrier, métallique.
Ramasse-mégots peint en noir. Grille
chromée. Enjoliveurs sur ouverture et base.
Cuvette intérieure pour le vidage.
Couleurs: noir, graphite, RAL 9006.

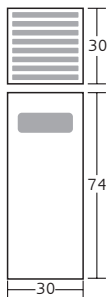

B-10

Papelera-cenicero metálico. Recogecolillas pintado, en negro. Tapa cromada. Embellecedores cromados.

Colores: negro, grafito, azul, burdeos, RAL 9006.

Metal bin-ashtray. Cigarettes butt-holder black painted. Chromed lid. Chromed trims.
Colours: black, graphite (dark gray), blue, burgundy, RAL 9006.

Corbeille à papier-cendrier, métallique.

Ramasse-mégots peint en noir. Couvercle chromé.

Enjoliveurs chromés.

Couleurs: noir, graphite, bleu, bordeaux, RAL 9006.

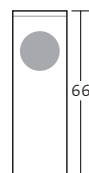
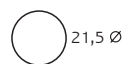

B-33

Papelera-cenicero metálico. Recogecolillas pintado, en negro. Embellecedores en abertura y base.

Colores: negro, grafito, azul, burdeos, RAL 9006.

Metal bin-ashtray. Cigarettes butt-holder black painted. Trims around opening and base.
Colours: black, graphite (dark gray), blue, burgundy, RAL 9006.

Corbeille à papier-cendrier, métallique. Ramasse-mégots

peint en noir, enjoliveurs sur ouverture et base.

Couleurs: noir, graphite, bleu, bordeaux, RAL 9006.



B-25

Papelera-cenicero metálico. Recogecolillas pintado en negro. Embellecedores en negro.
Colores: negro, grafito, azul, burdeos, RAL 9006.

Metal bin-ashtray. Cigarettes butt-holde black painted.
Black trim.
Colours: black, graphite (dark gray), blue, burgundy, RAL 9006.

Corbeille à papier-cendrier, métallique. Ramasse-mégots peint en noir. Enjoliveurs en noir.
Couleurs: noir, graphite, bleu, bordeaux, RAL 9006.

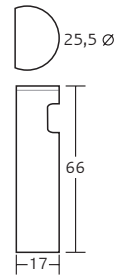

B-51

Papelera-cenicero inoxidable. Recogecolillas pintado en negro. Rejilla cromada. Embellecedores en negro.

Stainless ashtray/wastepaper basket. Tray painted black. Chromed grate. Black trim.

Corbeille-cendrier à papiers inoxydable. Recueille-mégots peint en noir. Grille chromée. Enjoliveurs noirs.

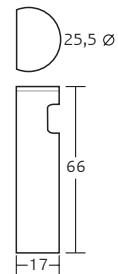

B-11

Papelera-cenicero inoxidable. Recogecolillas pintado en negro. Tapa cromada. Embellecedores cromados.

Stainless bin-ashtray. Cigarettes butt-holder black painted. Chromed lid. Chromed trims.

Cendrier à papier-cendrier, inoxydable. Ramasse-mégots peint en noir. Enjoliveurs chromés.

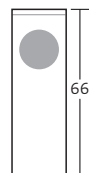
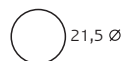

B-34

Papelera-cenicero inoxidable. Recogecolillas pintado en negro. Embellecedores en abertura y base.

Stainless bin-ashtray. Cigarettes butt-holder black painted. Trims around opening and base.

Corbeille à papier-cendrier, inoxydable. Ramasse-mégots peint en noir. Enjoliveurs à l'ouverture et à la base.

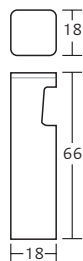

B-63

Papelera-cenicero metálico. Recogecolillas pintado en negro. Tapa de papelera abatible. Papelera extraíble. Embellecedor en negro. Colores: negro, grafito, RAL 9006.

Metal bin-ashtray. Cigarettes butt-holder black painted. Tip-up lid. Removable waste-paper bin. Black trim. Colours: black, graphite (dark gray), RAL 9006.

Corbeille à papier-cendrier métallique. Ramasse-métallique. Ramasse-mégots peint en noir. Couvercle de corbeille à papier abattable. Corbeille à papier extractible. Enjoliveur en noir. Couleurs: noir, graphite, RAL 9006.

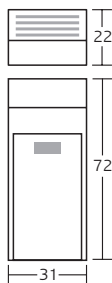

B-50

Papelera-cenicero metálico.
Recogecolillas pintado en negro.
Embellecedor en negro.
Colores: negro, grafito, RAL 9006.

Metal bin-ashtray. Cigarettes butt-holder black painted. Black trim.
Colours: black, graphite (dark gray), RAL 9006.

Corbeille à papier-cendrier, métallique. Ramasse-mégots peint en noir. Enjoliveur en noir.
Couleurs: noir, graphite, RAL 9006.

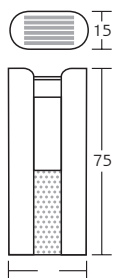

31



B-18

Papelera-cenicero metálico. Recogecolillas pintado en negro. Tapa cromada. Embellecedores cromados.

Colores: negro, grafito, RAL 9006.

Metal bin-ashtray. Cigarettes butt-holder black painted. Chromed lid. Chromed trims.

Colours: black, graphite (dark gray), RAL 9006.

Corbeille à papier-cendrier, métallique.

Ramasse-mégots peint en noir. Couvercle chromé.

Enjoliveurs chromés.

Couleurs: noir, graphite, RAL 9006.

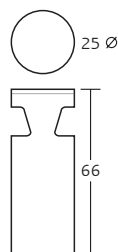

B-66

Papelera-cenicero metálico. Recogecolillas pintado en negro. Embellecedores en abertura y base.

Colores: negro, grafito, RAL 9006.

Metal bin-ashtray. Cigarettes butt-holder black painted. Trims at opening and base.

Colours: black, graphite (dark gray), RAL 9006.

Corbeille à papier-cendrier, métallique. Ramasse-mégots

peint en noir. Enjoliveurs l'ouverture et à la base.

Couleurs: noir, graphite, RAL 9006.

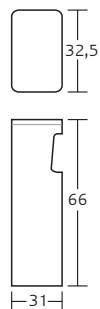

PERCHEROS DE PIE

COAT STAND HANGERS

PORTEMANTEAUX SUR PIED

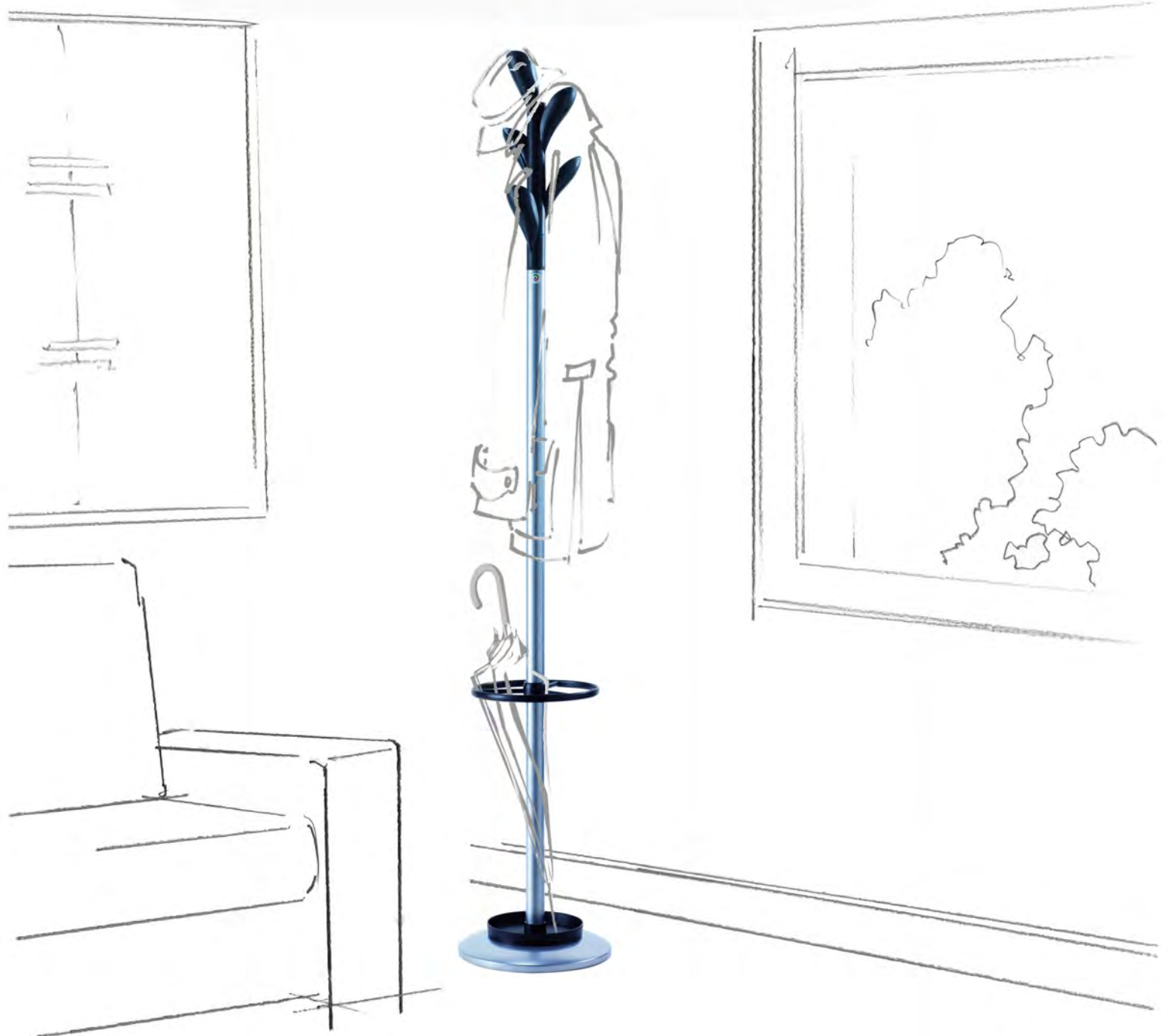

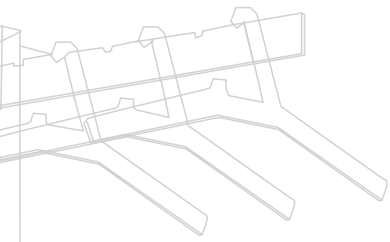

H-21

Perchero metálico.
Colgadores orientables en ABS negro.
Colores: negro, grafito, RAL 9006.

Metal coat stand hanger.
ABS swivel black hangers.
Colours: black, graphite (dark gray),
RAL 9006.

Portemanteau métallique.
Crochets orientables en ABS noir.
Couleurs: noir, graphite, RAL 9006.

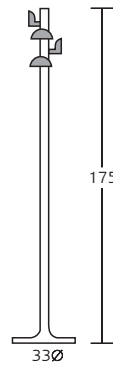

H-21D*

Perchero metálico desmontable.
Colgadores orientables en ABS negro.
Colores: negro, grafito, RAL 9006.

Detachable metal coat stand hanger.
ABS swivel black hangers.
Colours: black, graphite (dark gray),
RAL 9006.

Portemanteau métallique démontable.
Crochets orientables en ABS noir.
Couleurs: noir, graphite, RAL 9006.

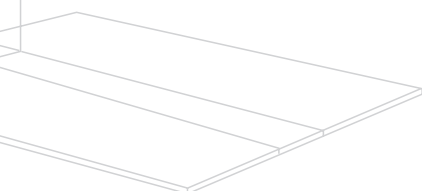

H-12

Perchero metálico de ocho colgadores con bolas cromadas.
Colores: negro, grafito, azul, burdeos, RAL 9006.

Metal coat hanger with eight chromed balls hangers.
Colours: black, graphite (dark gray), blue, burgundy, RAL 9006.

Portemanteau métallique à huit crochets à boules chromées.
Couleurs: noir, graphite, bleu, bordeaux, RAL 9006.

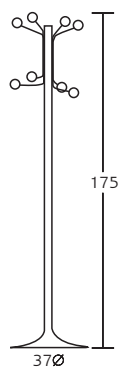

H-12D*

Perchero metálico desmontable de ocho colgadores con bolas cromadas.
Colores: negro, grafito, azul, burdeos, RAL 9006.

Detachable metal coat hanger with eight chromed balls hangers.
Colours: black, graphite (dark gray), blue, burgundy, RAL 9006.

Portemanteau métallique démontable à huit crochets à boules chromées.
Couleurs: noir, graphite, bleu, bordeaux, RAL 9006.



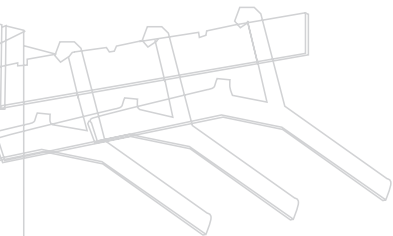

H-18

**Perchero-Paragüero metálico.
Brazos orientables en ABS negro.
Colores: negro, grafito, RAL 9006.**

**Metal coat-umbrella stand.
With adjustable arms in black ABS.
Colours: black, graphite (dark gray),
RAL 9006.**

**Porte-manteau-porte-parapluie métallique.
Bras orientables, en ABS noir.
Couleurs: noir, graphite, RAL 9006.**

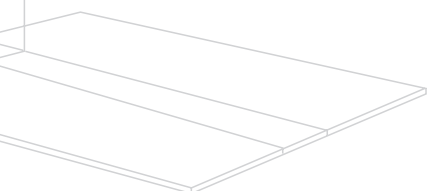

H-22

Perchero metálico. Colgadores orientables en ABS negro. Colores: negro, grafito, RAL 9006.

Metal coat stand hanger.
ABS swivel black hangers.
Colours: black, graphite (dark gray),
RAL 9006.

Portemanteau métallique. Crochets orientables en ABS noir.
Couleurs: noir, graphite, RAL 9006.



H-22D*

Perchero metálico desmontable. Colgadores orientables en ABS negro. Colores: negro, grafito, RAL 9006.

Detachable metal coat hanger.
ABS swivel black hangers.
Colours: black, graphite (dark gray),
RAL 9006.

Portemanteau métallique démontable.
Crochets orientables en ABS noir.
Couleurs: noir, graphite, RAL 9006.



H-16

Perchero metálico de ocho colgadores con bolas cromadas.

Colores: negro, grafito, RAL 9006.

Metal coat hanger with eight chromed balls hangers.

Colours: black, graphite (dark gray), RAL 9006.

Portemanteau métallique à huit crochets à boules chromées.

Couleurs: noir, graphite, RAL 9006.

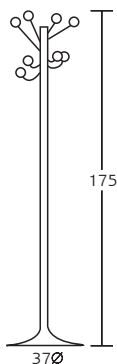

H-16D*

Perchero metálico desmontable de ocho colgadores con bolas cromadas.

Colores: negro, grafito, RAL 9006.

Detachable metal coat hanger with eight chromed balls hangers.

Colours: black, graphite (dark gray), RAL 9006.

Portemanteau métallique démontable à huit crochets à boules chromées.

Couleurs: noir, graphite, RAL 9006.

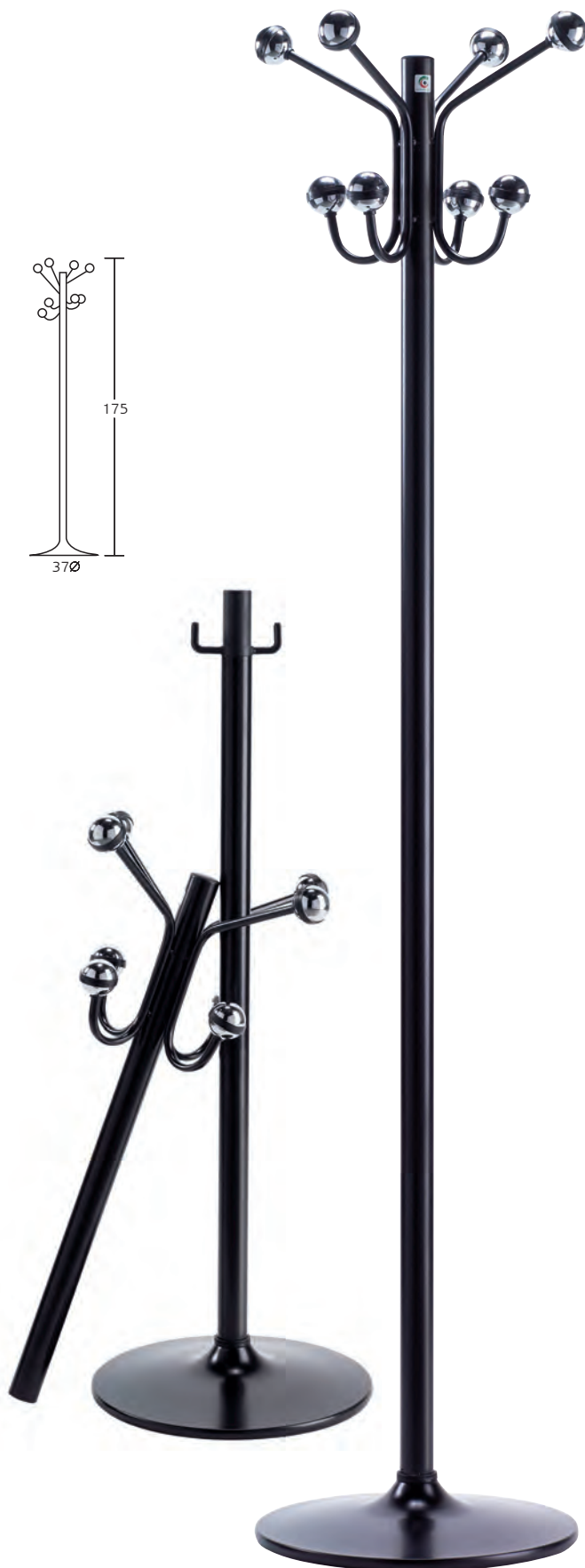

H-17

Perchero metálico con colgador de bolsos. Brazos orientables en ABS negro.
Colores: negro, grafito, RAL 9006.

Metal coat stand with purse hanger.
With adjustable arms in black ABS.
Colours: black, graphite (dark gray), RAL 9006.

Porte-manteau métallique porte-sacs.
Bras orientables, en ABS noir.
Couleurs: noir, graphite, RAL 9006.

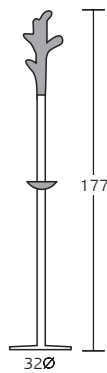

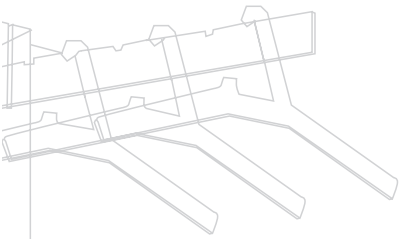

H-11

Perchero metálico cromado de seis colgadores con bolas cromadas.

Chromed metal coat hanger with six chromed balls hangers.

Portemanteau métallique chromé à six crochets à boules chromées.

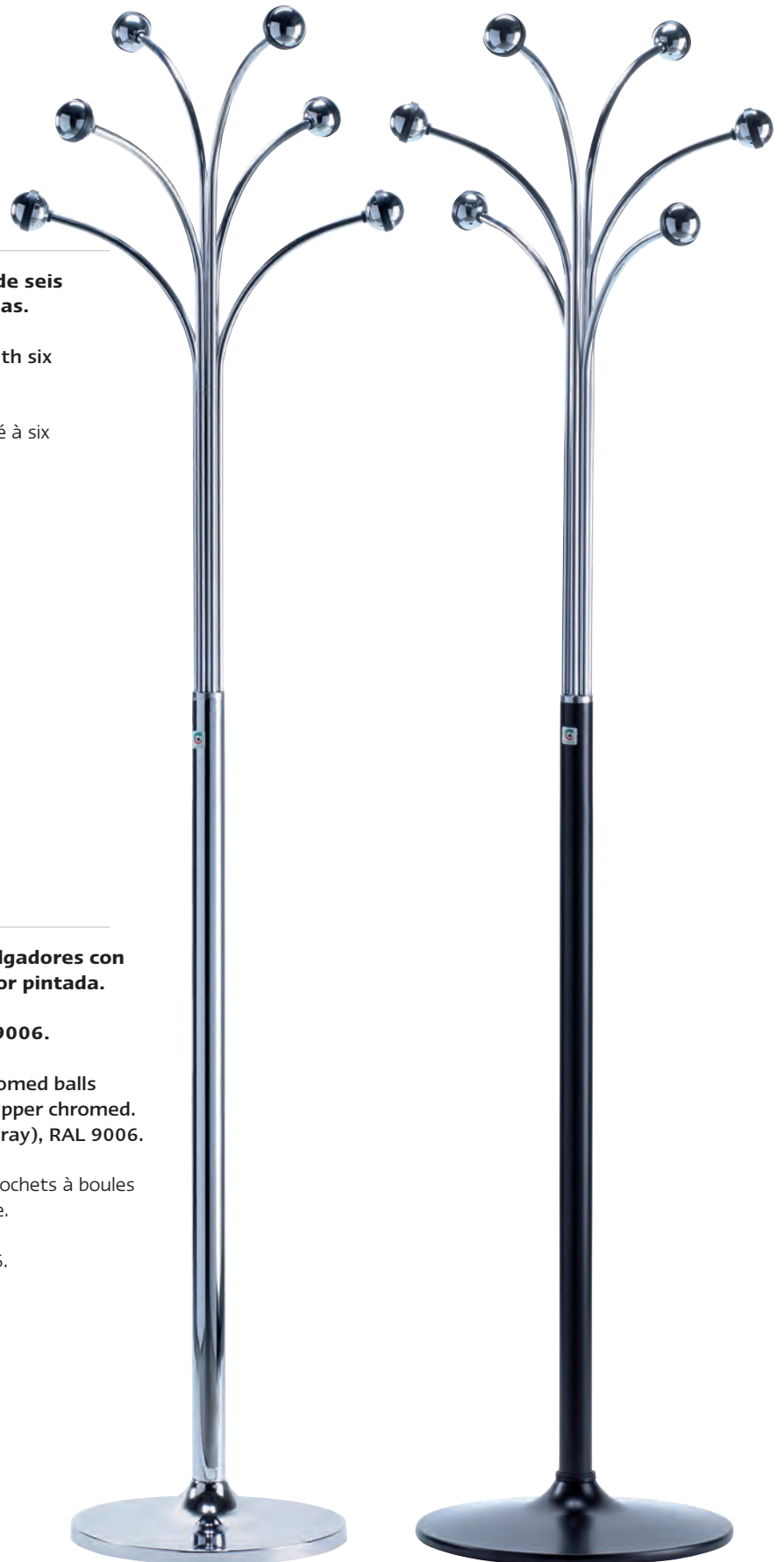
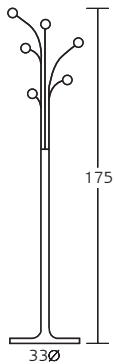

H-10

Perchero metálico de seis colgadores con bolas cromadas. Parte inferior pintada. Parte superior cromada. Colores: negro, grafito, RAL 9006.

Metal coat hanger with six chromed balls hangers. Lower part painted. Upper chromed. Colours: black, graphite (dark gray), RAL 9006.

Portemanteau métallique à six crochets à boules chromées. Partie inférieure peinte. Partie supérieure chromée. Couleurs: noir, graphite, RAL 9006.

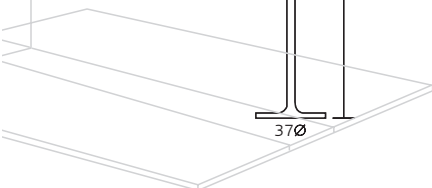
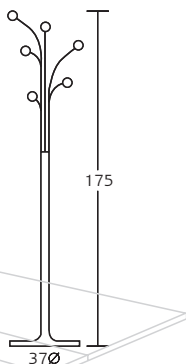

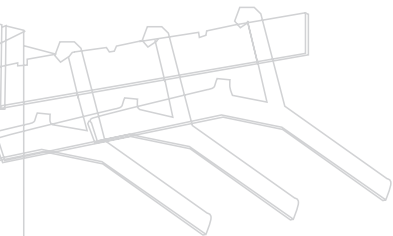

H-25

**Perchero metálico cromado.
Colgadores orientables en ABS negro.**

**Chromed metal coat stand hangers.
ABS swivel black hangers.**

Portemanteau métallique chromé.
Crochets orientables en ABS noir.



H-23

**Perchero metálico cromado.
Colgadores orientables en ABS negro.**

**Chromed metal coat stand hangers.
ABS swivel black hangers.**

Portemanteau métallique chromé.
Crochets orientables en ABS noir.

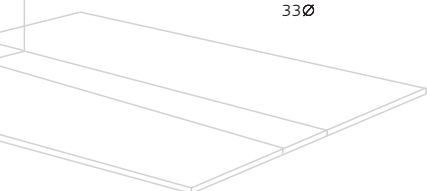
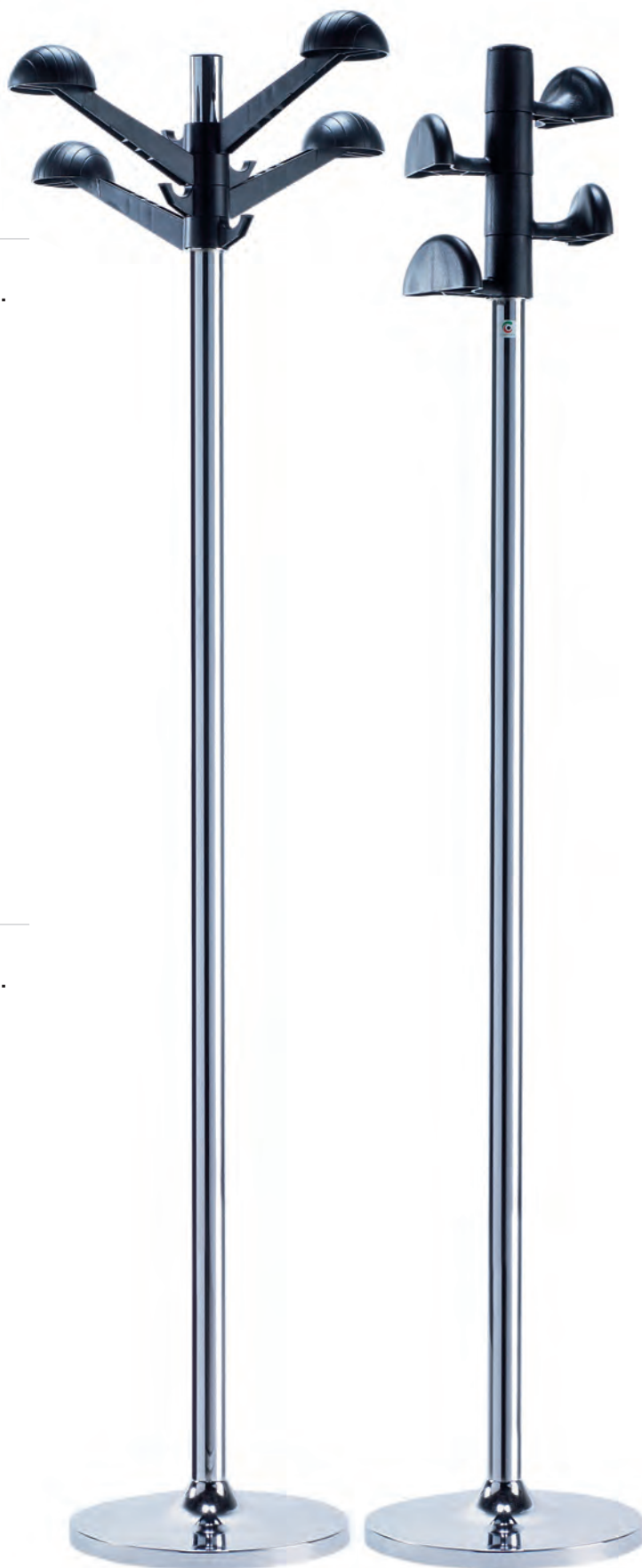

PERCHAS DE PARED

HANGERS OF WALL

SUPPORT MURAL

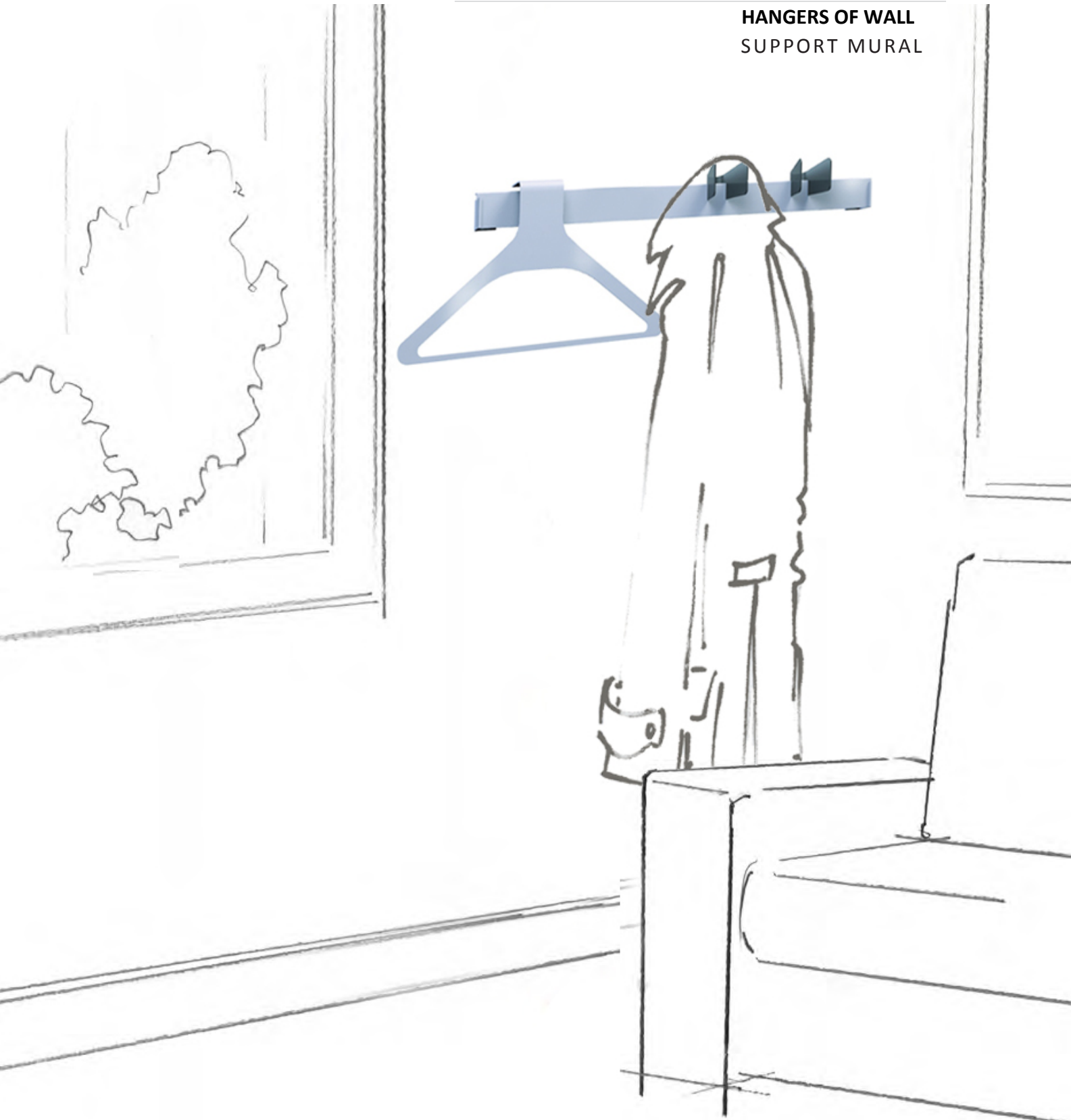

H-13

Percha de pared metálica de tres colgadores cromados.

Colores: negro, grafito, azul, burdeos, blanco, RAL 9006.

Metal wall coat hanger rack with three chromed hangers.
Colours: black, graphite (dark gray), blue, burgundy, white, RAL 9006.

Portemanteau mural métallique à trois crochets chromés.
Couleurs: noir, graphite, bleu, bordeaux, blanc, RAL 9006.

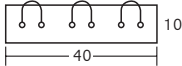

H-14

Percha de pared metálica de cuatro colgadores cromados.

Colores: negro, grafito, azul, burdeos, blanco, RAL 9006.

Metal wall coat hanger rack with four chromed hangers.
Colours: black, graphite (dark gray), blue, burgundy, white, RAL 9006.

Portemanteau mural métallique à quatre crochets chromés.
Couleurs: noir, graphite, bleu, bordeaux, blanc, RAL 9006.

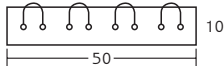

H-15

Percha de pared metálica de cinco colgadores cromados.

Colores: negro, grafito, azul, burdeos, blanco, RAL 9006.

Metal wall coat hanger rack with five chromed hangers.
Colours: black, graphite (dark gray), blue, burgundy, white, RAL 9006.

Portemanteau mural métallique à cinq crochets chromés.
Couleurs: noir, graphite, bleu, bordeaux, blanc, RAL 9006.

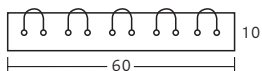

H-42

Percha de pared metálica con
2 colgadores de policarbonato negro.
Colores: negro, RAL 9006.

Metal coat rack with 2 hooks in black
polycarbonate.
Colours: black, RAL 9006.

Porte manteau mural métallique avec
2 crochets en polycarbonate noir.
Couleurs: noir, RAL 9006.

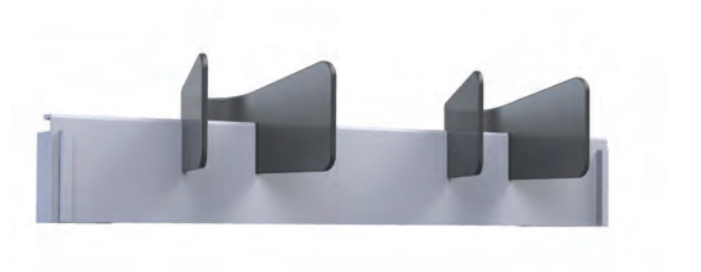
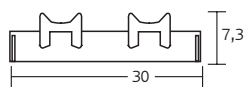

H-43

Percha de pared metálica con
3 colgadores de policarbonato negro.
Colores: negro, RAL 9006.

Metal coat rack with 3 hooks in black
polycarbonate.
Colours: black, RAL 9006.

Porte manteau mural métallique avec
3 crochets en polycarbonate noir.
Couleurs: noir, RAL 9006

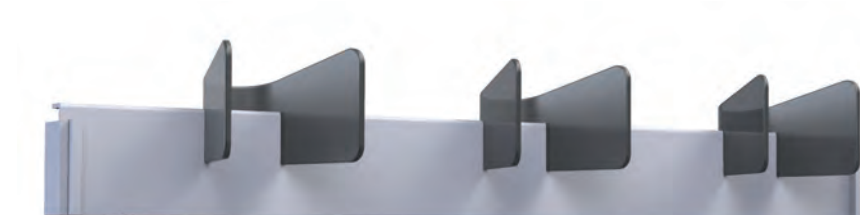
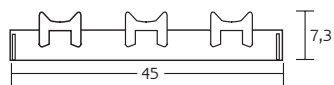

H-44

**Percha de pared metálica con
4 colgadores de policarbonato negro.
Colores: negro, RAL 9006.**

Metal coat rack with 4 hooks in black
polycarbonate.
Colours: black, RAL 9006.

Porte manteau mural métallique avec
4 crochets en polycarbonate noir.
Couleurs: noir, RAL 9006.

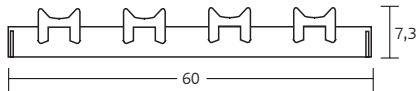

H-45

**Percha de pared metálica con
5 colgadores de policarbonato negro.
Colores: negro, RAL 9006.**

Metal coat rack with 5 hooks in black
polycarbonate.
Colours: black, RAL 9006.

Porte manteau mural métallique avec
5 crochets en polycarbonate noir.
Couleurs: noir, RAL 9006

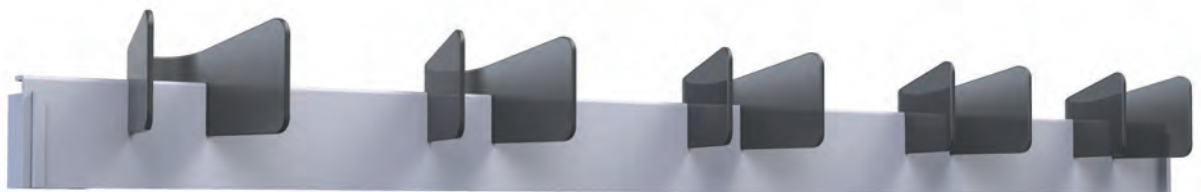
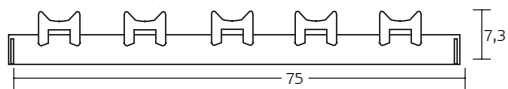

H-46

Soporte de pared metálico con 2 colgadores de policarbonato negro y 1 percha metálica.
Colores: negro, RAL 9006.

Metal hook rail with 2 hooks in black polycarbonate and 1 metal hanger.
Colours: black, RAL 9006.

Suport mural métallique avec 2 crochets en polycarbonate noir et 1 cintre métallique.
Couleurs: noir, RAL9006.

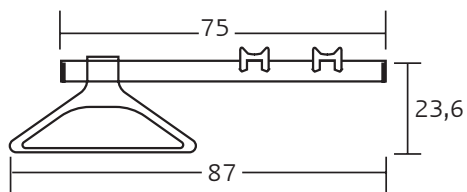

H-47

Soporte de pared metálico con 2 perchas metálicas.
Colores: negro, RAL 9006.

Metal hook rail with 2 metal hangers.
Colours: black, RAL 9006.

Suport mural métallique avec 2 cintres métalliques.
Couleurs: noir, RAL 9006.

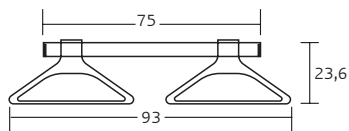

H-19

Percha de pared metálica de cuatro colgadores con bolas cromadas.

Colores: negro, grafito, RAL 9006.

Metal wallcoat hanger rack with four chromed balls hangers.

Colours: black, graphite (dark gray), RAL 9006.

Portemanteau mural métallique à quatre crochets à boules chromées.

Couleurs: noir, graphite, RAL 9006.

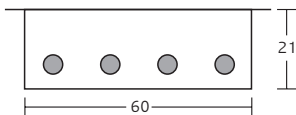

H-20

Percha de pared metálica de seis colgadores con bolas cromadas.

Colores: negro, grafito, RAL 9006.

Metal wall coat hanger rack with six chromed balls hangers.

Colours: black, graphite (dark gray), RAL 9006.

Portemanteau mural métallique à six crochets à boules chromées.

Couleurs: noir, graphite, RAL 9006.

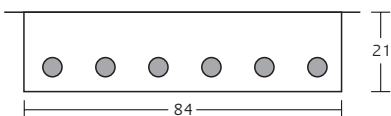

PARAGÜEROS
UMBRELLA STANDS
PORTE-PARAPLUIES



G-14

Paragüero inoxidable perforado.
Embellecedor base en negro.
Recogeaguas en el interior.

Perforated stainless umbrella stand.
Black trim on base. Inner drip tray.

Porte-parapluie inoxydable perforé.
Enjoliveur base noir. Recueille-gouttes à l'intérieur.

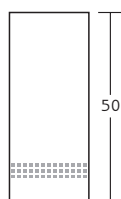

G-23

Paragüero inoxidable.
Embellecedores en negro.
Recogeaguas en el interior.

Stainless umbrella stand.
Black trims. Water catcher inside.

Porte-parapluie inoxydable.
Enjoliveur en noir. Bac à l'eau à l'intérieur.

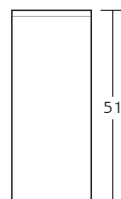

G-15

Paragüero ABS con remate superior.

Bastidor metálico.

Colores: paragüero negro con bastidor RAL 9006.

Paragüero plata con bastidor negro.

ABS Umbrella stand with upper rim. Metallic chasis.

Colours: black Umbrella stand, RAL 9006 painted chasis.

Silver Umbrella stand, black chasis.

Porte-parapluie en ABS avec enjoliveur supérieur.

Chassis métallique.

Couleurs: Porte-parapluie noir avec chassis RAL 9006.

Porte-parapluie argent avec chassis noir.

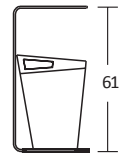

G-22

**Paragüero metálico. Embellecedores en negro.
Recogeaguas en el interior.
Colores: negro, grafito, azul, burdeos, RAL 9006.**

Metal umbrella stand. Black trims.
Water catcher inside.
Colours: black, graphite (dark gray), blue, burgundy,
RAL 9006.

Porte-parapluie métallique. Enjoliveurs en noir.
Bac à l'eau l'intérieur.
Couleurs: noir, graphite, bleu, bordeaux, RAL 9006.

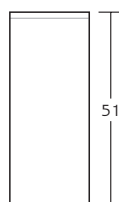

G-10

**Paragüero metálico con dos asas. Embellecedor
en negro. Recogeaguas en el interior.
Colores: negro, grafito, azul, burdeos, RAL 9006.**

Metal umbrella stand with two handles. Black trim.
Water catcher inside.
Colours: black, graphite (dark gray), blue, burgundy,
RAL 9006.

Porte-parapluies métallique à deux anses.
Enjoliveur en noir.
Bac à l'eau à l'intérieur.
Couleurs: noir, graphite, bleu, bordeaux, RAL 9006.

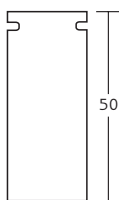

G-25

Paragüero metálico. Soportes cromados. Recogeaguas ABS negro.
Colores: negro, grafito, RAL 9006.

Metal umbrella stand. Chromed supports.
ABS black water pan.
Colours: black, graphite (dark gray),
RAL 9006.

Porte-parapluies métallique. Supports chromés.
Récupérateur d'eau ABS noir.
Couleurs: noir, graphite, RAL 9006.

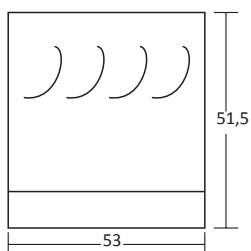

G-18

Paragüero metálico perforado. Aros cromados. Recogeaguas en el interior. Colores: negro, grafito, RAL 9006.

Perforated metal umbrella stand. Chromed rings. Water catcher inside. Colours: black, graphite (dark gray), RAL 9006.

Porte-parapluies métallique perforé. Bandages chromés. Bac à l'eau à l'intérieur. Couleurs: noir, graphite, RAL 9006.

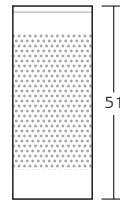

G-11

Paragüero metálico perforado con dos asas. Embellecedor en negro. Recogeaguas en el interior. Colores: negro, grafito, RAL 9006.

Perforated metal umbrella stand with two handles. Black trim. Water catcher inside. Colours: black, graphite (dark gray), RAL 9006.

Porte-parapluies métallique perforé. Bandages chromés. Bac à l'eau à l'intérieur. Couleurs: noir, graphite, RAL 9006.

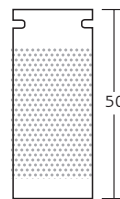

G-26

Paragüero metálico.
Soporte y recogeaguas en ABS negro.
Colores: negro, RAL 9006.

Metal umbrella stand.
Base and drip tray in black ABS.
Colours: black, RAL 9006.

Porte-parapluie métallique.
Support et recueille-gouttes en ABS noir.
Couleurs: noir, RAL 9006.

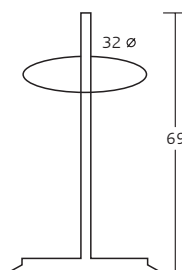

G-17

Paragüero metálico forrado vinilo. Aros cromados.
Recogeaguas en el interior.
Colores: negro, marrón.

Vinyl lined metal umbrella stand. Chromed rings.
Water catcher inside.
Colours: black, brown.

Porte-parapluies métallique à doublure en vinyle.
Bandages chromés. Bac à l'eau à l'intérieur.
Couleurs: noir, bron.

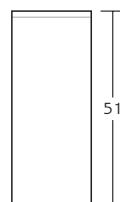

ACCESORIOS DE SOBREMESA

TABLETOP ACCESSORIES

ACCESSOIRES DE TABLE





V-80

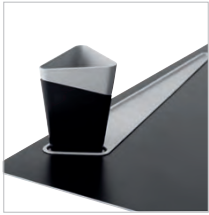

V-80

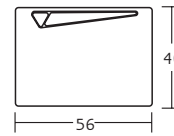

Vade sobremesa con plumier encastrado.
Superficie multicapa vinílica en negro.
Plumier ABS en plata.

Desk pad with pen stands.
 Multilayered black vinyl surface.
 ABS. Silver-plated pencil cup.

Sous-main avec plumier encastré.
 surface multicouche vinylique noir.
 Plumier ABS en plaqué argent.

V-81



V-81

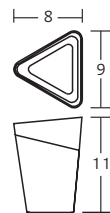

Portalápices ABS en negro con remate superior en plata.

ABS pencil holder in black with silver rim.

Porte-crayons ABS noir, bord supérieur en argent.

V-82



V-82

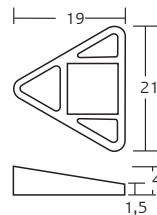

Porta notas y porta accesorios ABS en negro.

ABS memo holder and accessories holder in black.

Porte-notes et porte accessoires ABS noir.

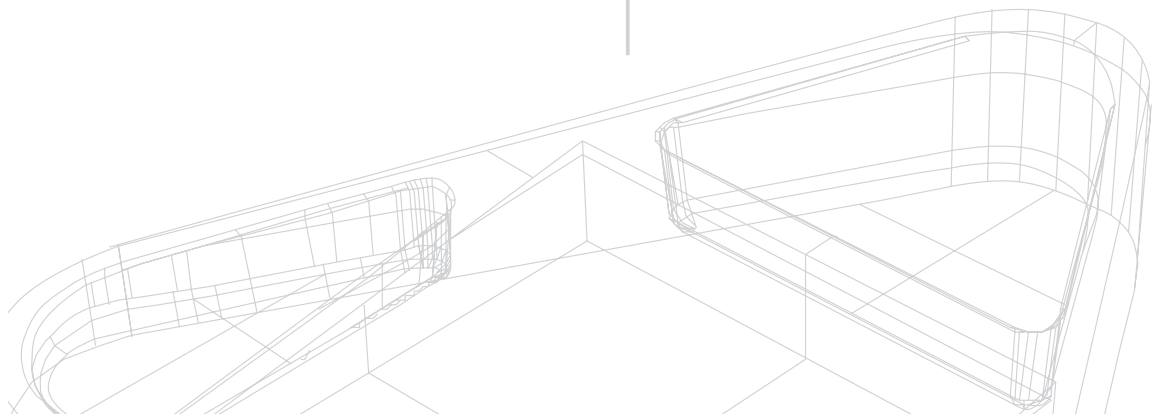



V-21

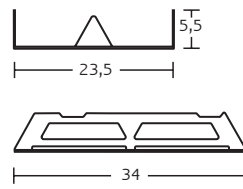

**Bandeja individual.
Aluminio anodizado.**

Individual tray.
Anodized aluminum.

**Plateau individuel.
Aluminium anodisé.**

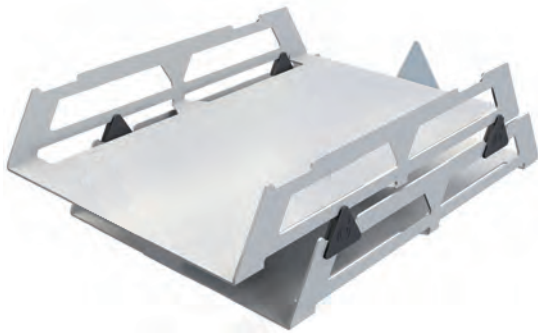

V-22

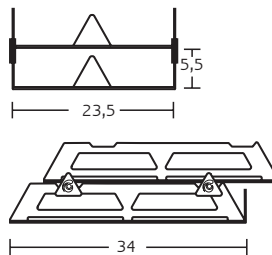

**Juego 2 bandejas.
Aluminio anodizado.**

Set of 2 trays.
Anodized aluminum.

**Jeux de 2 plateaux.
Aluminium anodisé.**

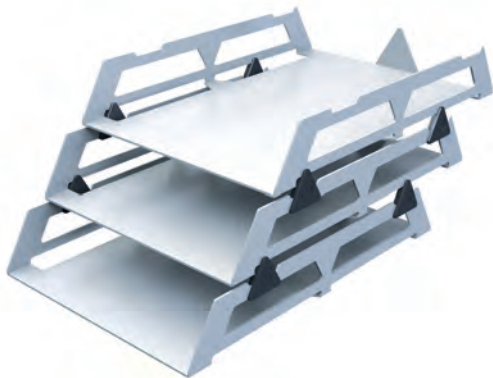

V-23

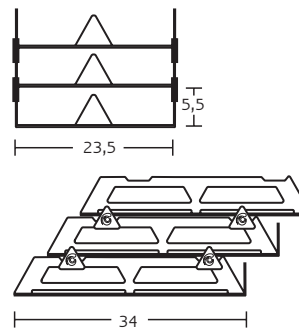

**Juego 3 bandejas.
Aluminio anodizado.**

Set of 3 trays.
Anodized aluminum.

**Jeux de 3 plateaux.
Aluminium anodisé.**



V-40

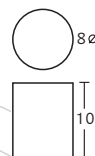

**Portapiceros aluminio
pulido. Aro aluminio pulido.**

Polished aluminium pencil
holder. Polished aluminium ring.

Porte-crayons en aluminium poli.
Bandage en aluminium poli.

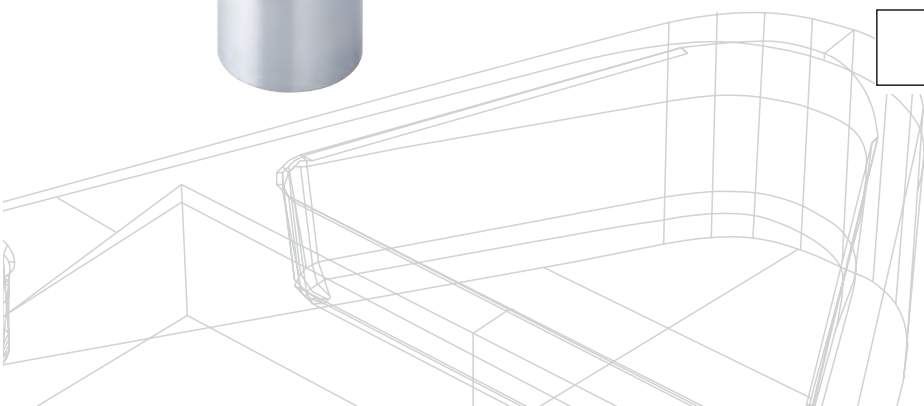

V-70

Bandeja metálica apilable.

Colores: negro, azul, burdeos, RAL 9006.

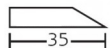

Stacking tray.

Colours: black, blue, burgundy, RAL 9006.

Plateau superposable métallique.

Couleurs: noir, blue, bordeaux, RAL 9006.

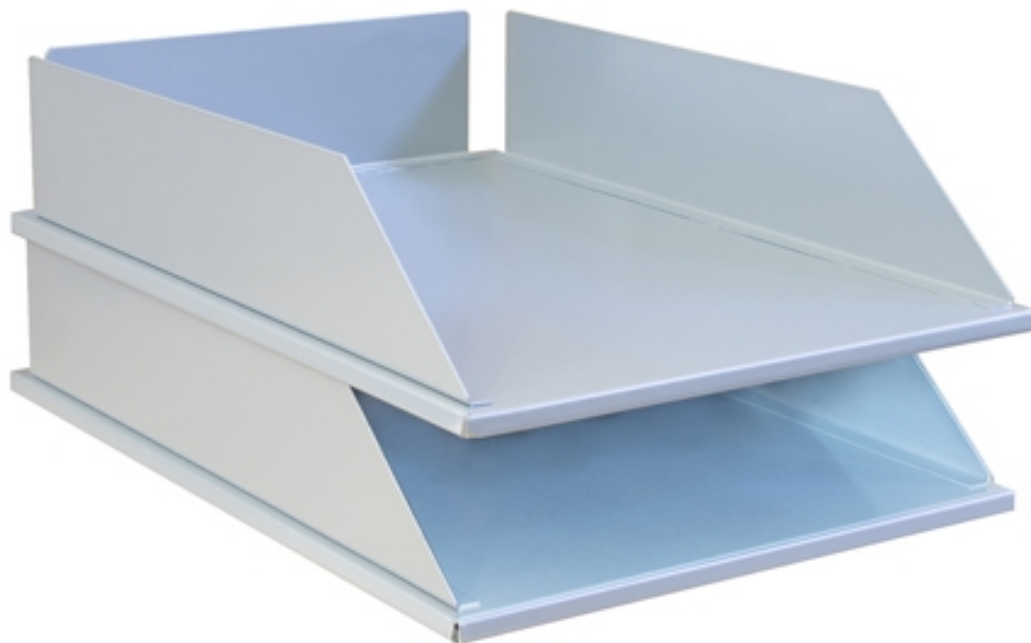

V-71



V-72



V-71

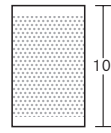
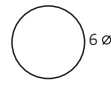

Portapapiceros. Chapa perforada.
Colores: negro, azul, burdeos, RAL 9006.

Pencil holder. Perforated sheet metal.
Colours: black, blue, burgundy, RAL 9006.

Porte-crayons. Tole perforée.
Couleurs: noir, blue, bordeaux, RAL 9006.

V-73

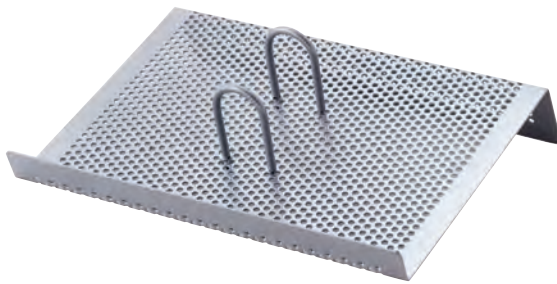

V-72

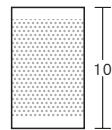
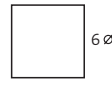

Portapapiceros. Chapa perforada.
Colores: negro, azul, burdeos, RAL 9006.

Pencil holder. Perforated sheet metal.
Colours: black, blue, burgundy, RAL 9006.

Porte-crayons. Tole perforée.
Couleurs: noir, blue, bordeaux, RAL 9006.

V-74



V-73

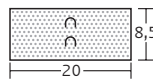

Portacalendarios. Chapa perforada.
Colores: negro, azul, burdeos, RAL 9006.

Calendar holders. Perforated sheet metal.
Colours: black, blue, burgundy, RAL 9006.

Porte calendrier. Tole perforée.
Couleurs: noir, blue, bordeaux, RAL 9006.

V-74

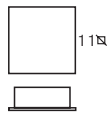

Portatacos. Chapa perforada.
Colores: negro, azul, burdeos, RAL 9006.

Cue-holder. Perforated sheet metal.
Colours: black, blue, burgundy, RAL 9006.

Porte bloc. Tole perforée.
Couleurs: noir, blue, bordeaux, RAL 9006.

V-75



V-75

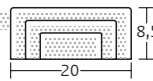

Portadocumentos. Chapa perforada.
Colores: negro, azul, burdeos, RAL 9006.

Document holder.
Perforated sheet metal.
Colours: black, blue, burgundy, RAL 9006.

Porte-documentes. Tole perforée.
Couleurs: noir, blue, bordeaux, RAL 9006.

JARDINERAS

PLANT POTS

JARDINIÈRES



JARDINERAS CON RIEGO POR ABSORCIÓN
ABSORPTION IRRIGATION PLANT POT
JARDINIÈRES À IRRIGATION PAR ABSORTION

J-21

Jardinera cuadrada con aro y ruedas giratorias.
Colores: negro, blanco.

Square plant pot with ring and swivel wheels.
Colours: black, white.

Jardinière carrée à cerceau et roues pivotantes.
Couleurs: noir, blanc.

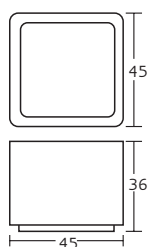

J-25

Jardinera redonda con aro y ruedas giratorias.
Colores: negro, blanco.

Round plant pot with ring and swivel wheels.
Colours: black, white.

Jardinière ronde à cerceau et roues pivotantes.
Couleurs: noir, blanc.

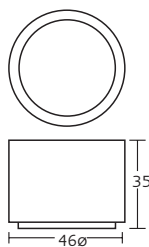

JARDINERAS CON RIEGO POR ABSORCIÓN
ABSORPTION IRRIGATION PLANT POT
JARDINIÈRES À IRRIGATION PAR ABSORTION

J-35

**Jardinera redonda acero inoxidable con aro
y ruedas giratorias.**

Round stainless steel jardiniere with hoop
and revolving wheels.

Jardinière ronde acier inoxydable avec cerceau
et roues pivotantes.

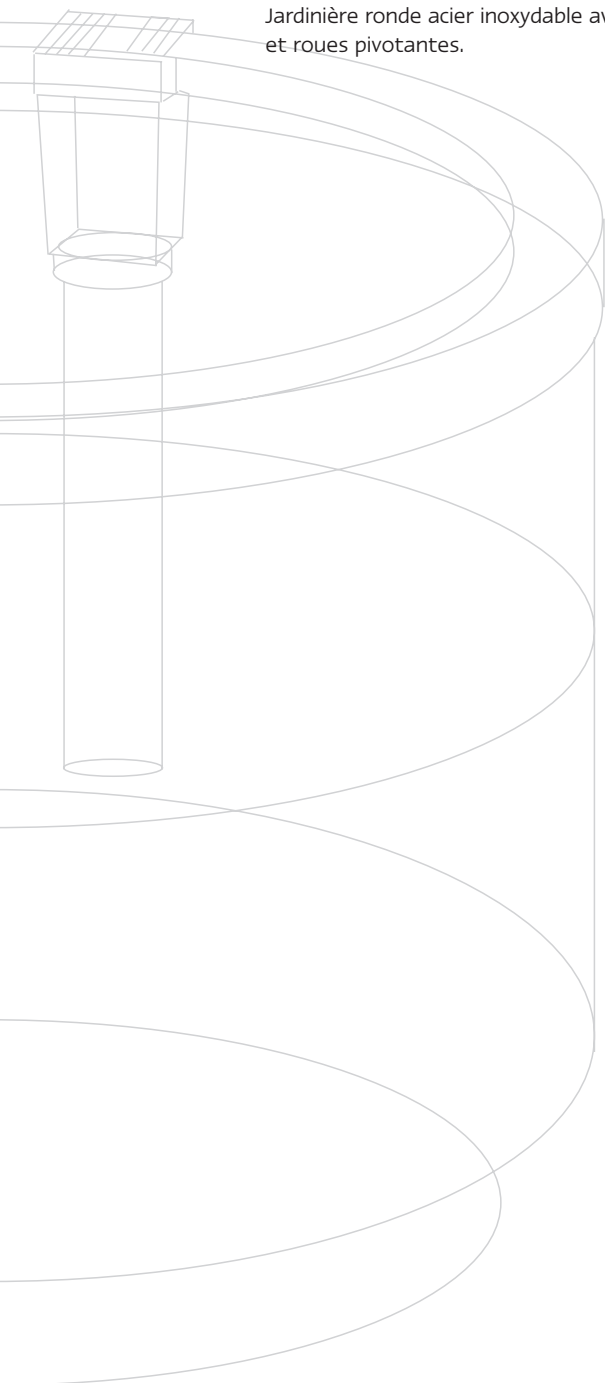
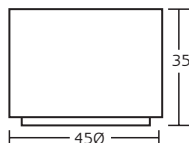
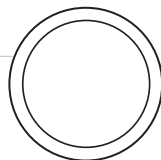

JARDINERAS CON RIEGO POR ABSORCIÓN
ABSORPTION IRRIGATION PLANT POT
JARDINIÈRES À IRRIGATION PAR ABSORTION

J-29

**Jardinera rectangular con aro
y ruedas giratorias.**

Rectangular jardiniere with hoop
and revolving wheels.

Jardinière rectangulaire avec cerceau
et roues pivotantes.

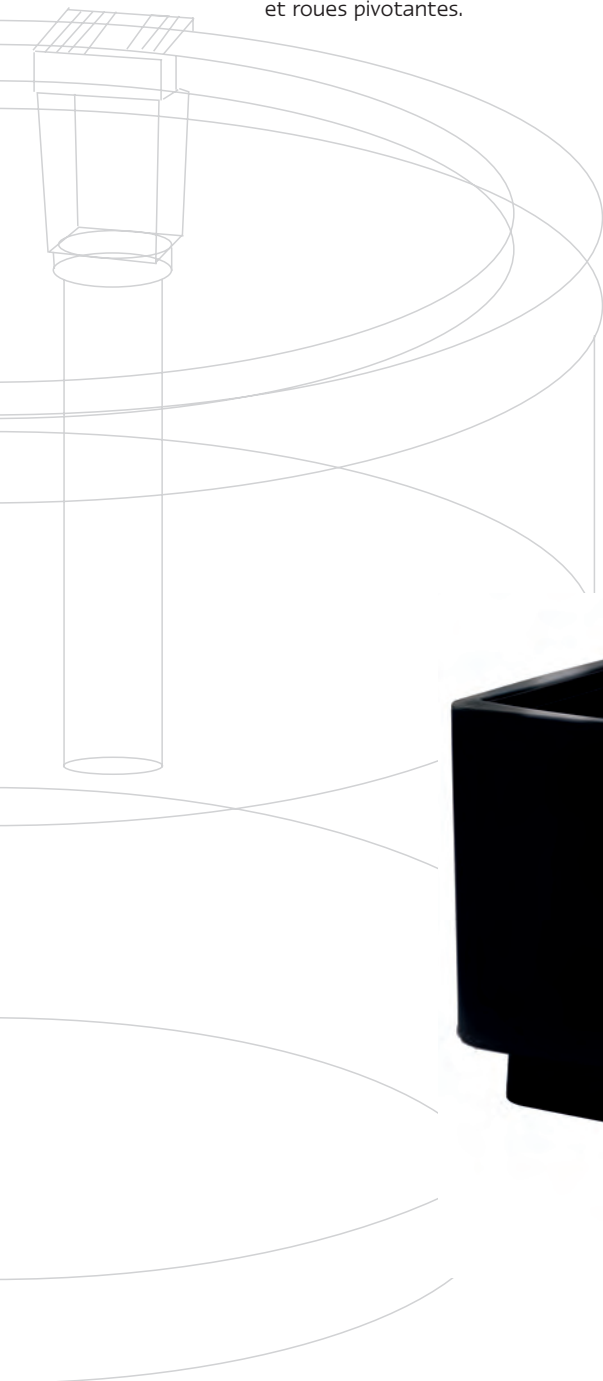
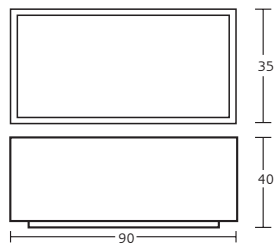

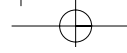

LÁMPARAS DE SOBREMESA

TABLETOP LAMPS

LAMPES POUR TABLE

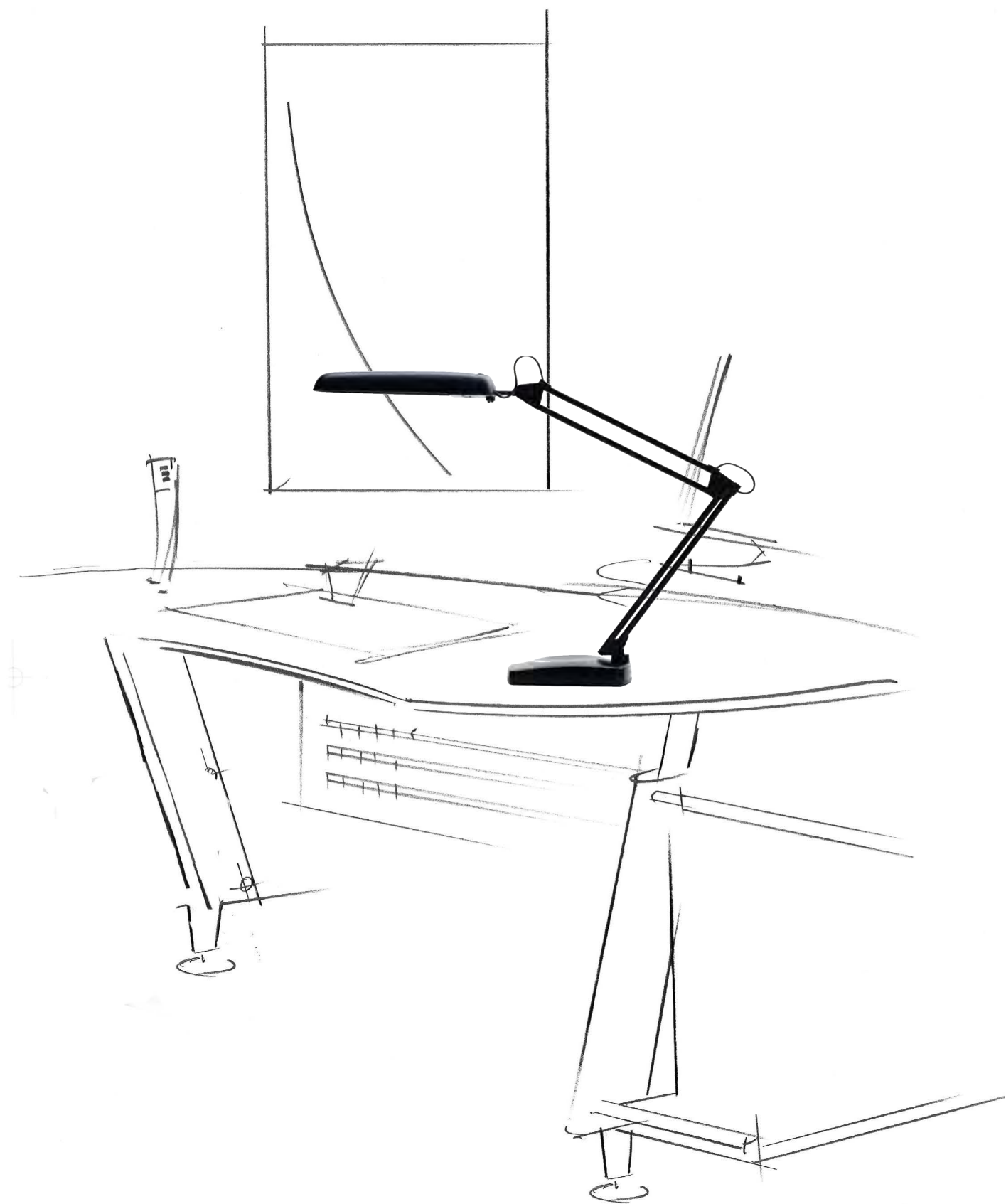

F-31

Lámpara halógena articulada orientable con base. Bombilla de 50 W.
Color: negro.

Adjustable articulated halogen lamp
with base.
50 W light bulb.
Colour: black.

Lampe halogène articulée, orientable à base.
Ampoule 50 W.
Couleur: noir.



F-33

Lámpara articulada orientable con base. Fluorescente de 11 W.
Color: negro.

Adjustable articulated lamp with base.
11 W florescent bulb.
Colour: black.

Lampe articulée, orientable à base.
Tube fluorescent 11 W.
Couleur: noir.



F-55

Lámpara halógena con doble intensidad de luz. Pantalla orientable. Rótulas negras. Bombilla de 50 W. Color: negro.

Two levels halogen lamp. Swivel screen. Black jointed 50 W bulb. Colour: black.

Lampe halogène à deux intensités lumineuses. Écran orientable. Rotules noirs. Ampoule à 50 W. Couleur: noir.

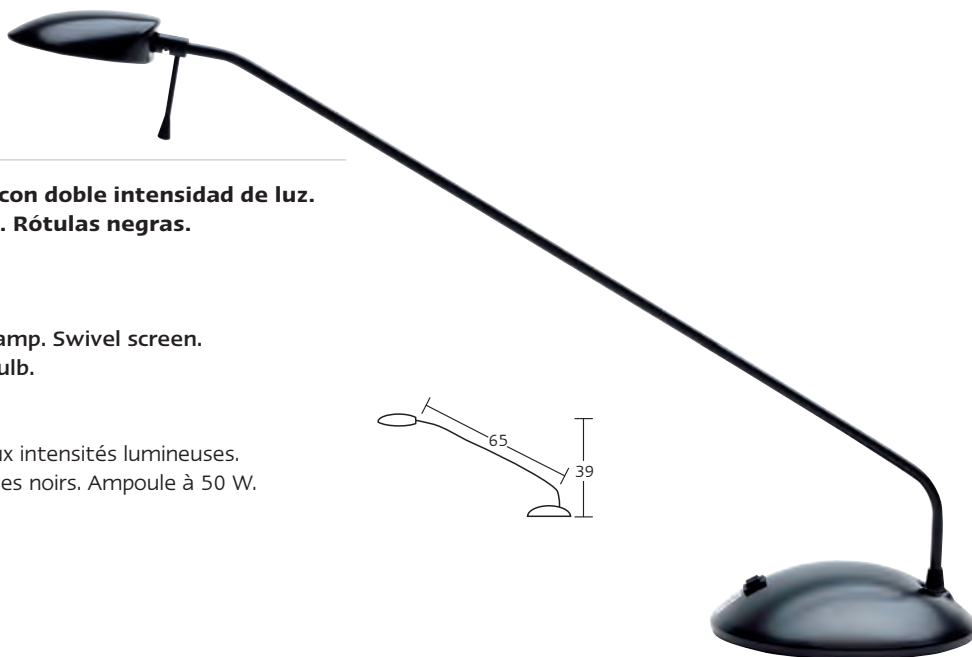
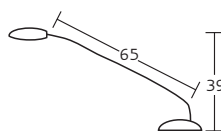

F-53

Lámpara halógena con regulador de intensidad de luz. Pantalla orientable. Rótulas doradas. Bombilla de 100 W. Color: negro.

Halogen lamp with light intensity regulator. Swivel screen. Gold jointed. 100 W bulb. Colour: black.

Lampe halogène avec régulateur d'intensité de lumière. Ecran orientable. Rotules dorées. Lampe à 100 W. Couleur: noir.

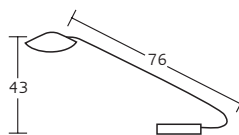

F-56

Lámpara halógena dorada con doble intensidad de luz. Pantalla orientable. Bombilla de 50 W.

Two-way gold halogen lamp.
Swivel screen, 50 W bulb.

Lampe halogène dorée à deux intensités lumineuses. Écran orientable.
Ampoule à 50 W.

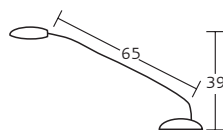

PLANOS Y PORTADOCUMENTOS

ROD PLAN HOLDER AND ROD DOCUMENT HOLDER
CHEVALET POUR PLANS ET PORTE-DOCUMENTES

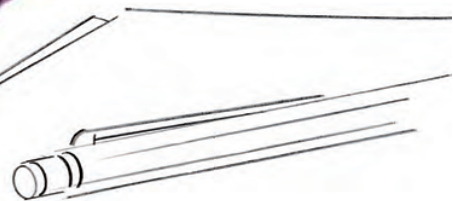
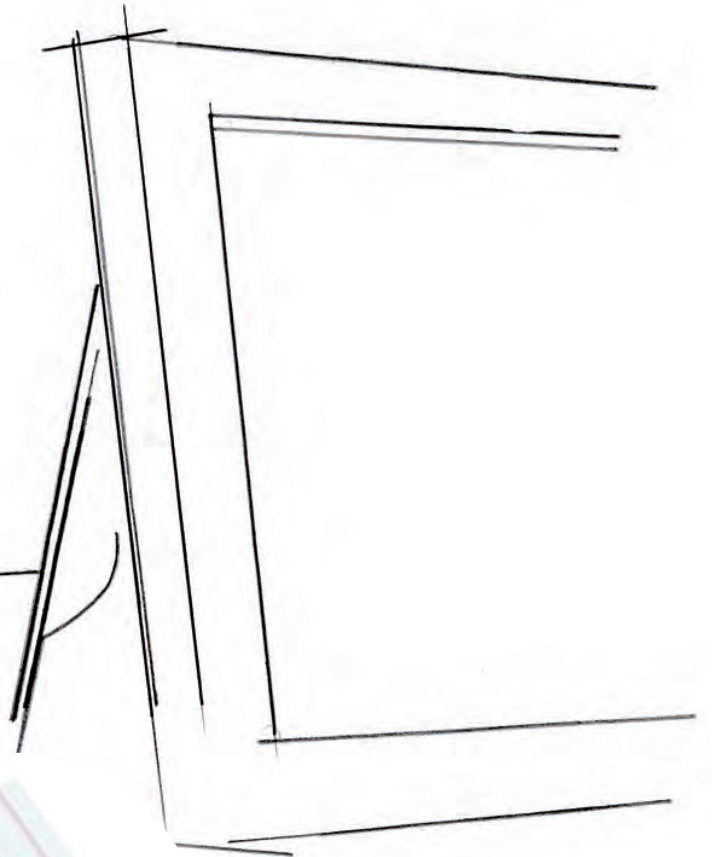
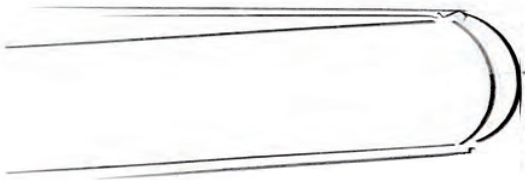

V-16

Portaplanos de varilla con ruedas giratorias.
Colores: negro, burdeos, RAL 9006.

Rod plan holder with swivel wheels.
Colours: black, burgundy, RAL 9006.

Chevalet pour plans à roues pivotantes.
Couleurs: noir, bordeaux, RAL 9006.

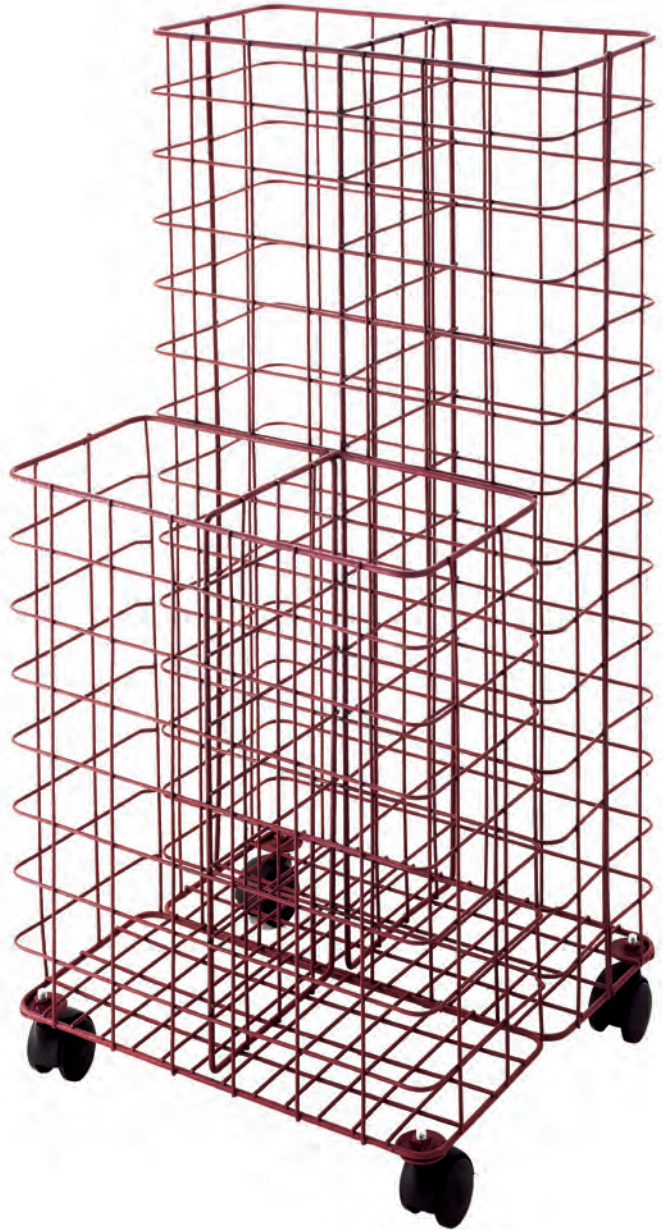

V-50

Portadocumentos de varilla.
Colores: negro, burdeos, RAL 9006.

Rod document holder.
Colours: black, burgundy, RAL 9006.

Porte-documents en tringle.
Couleurs: noir, bordeaux, RAL 9006.

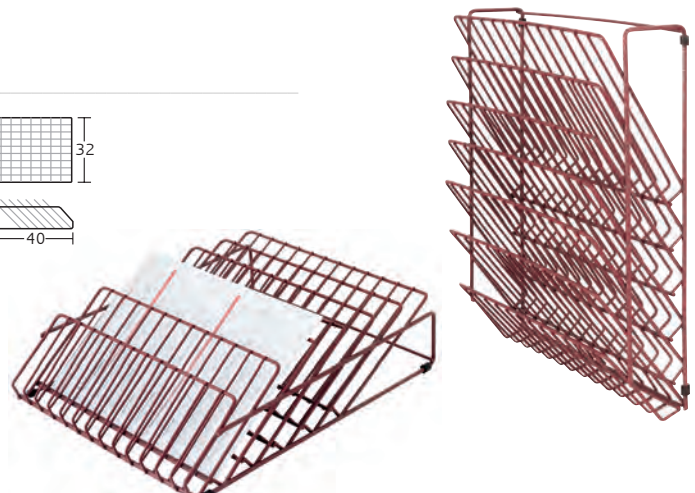
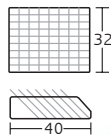

CENICEROS DE SOBREMESA Y PARDED

TABLETOP ASHTRAYS
CENDRIERS SUR TABLE

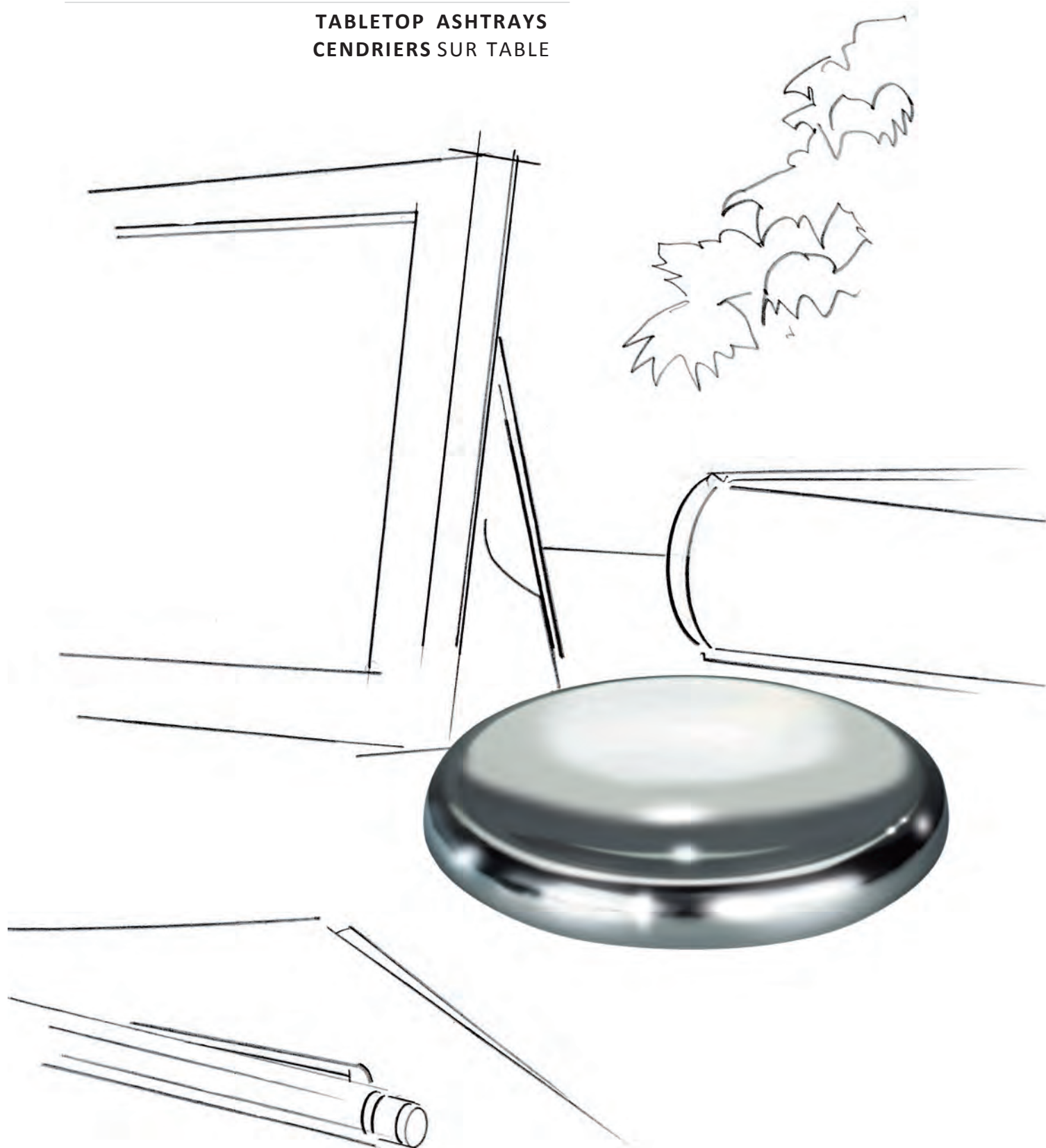

S-16

Cenicero metálico pintado. Tapa en negro.
Colores: negro, RAL 9006.

Painted metal ashtray, black lid.
Colours: black, RAL 9006.

Cendrier métallique peint. Couvercle en noir.
Couleurs: noir, RAL 9006.

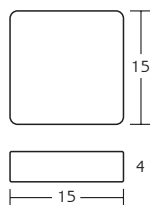

S-17

Cenicero metálico cromado.

Chromed metal ashtray.

Cendrier métallique chromé.

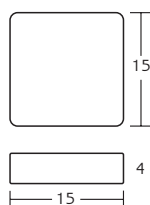

S-19

Cenicero metálico pintado. Tapa en negro.
Colores: negro, burdeos.

Painted metal ashtray, black lid.
Colours: black, burgundy.

Cendrier métallique peint. Couvercle en noir.
Couleurs: noir, bordeaux.

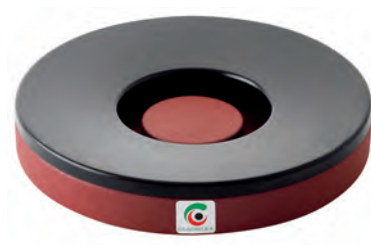
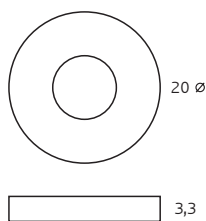

S-15

Cenicero metálico cromado con base de goma antideslizante.

Chromed metal ashtray with anti-slip rubber base.

Cendrier métallique chromé à base en caoutchouc antidérapante.

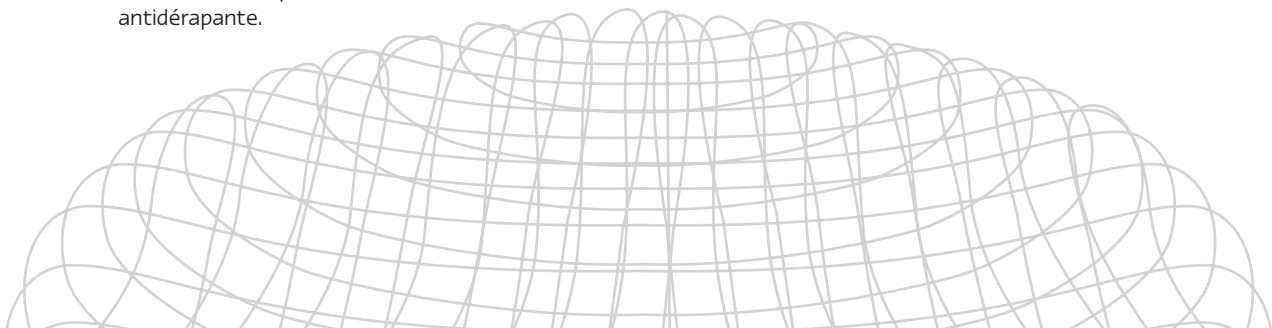
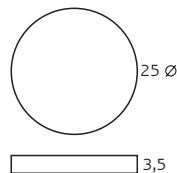

S-10

Cenicero metálico pintado.
Colores: negro, burdeos.

Painted metal ashtray.
Colours: black, burgundy.

Cendrier métallique peint.
Couleurs: noir, bordeaux.

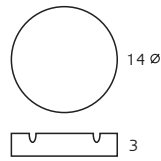

S-11

Cenicero metálico cromado.

Chromed metal ashtray.

Cendrier métallique chromé.

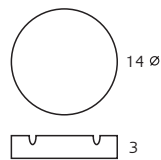

S-30

Cenicero cristal apilable.

Stacking glass ashtray.

Cendrier en verre empilable.

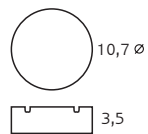

S-31

Cenicero cristal apilable.

Stacking glass ashtray.

Cendrier en verre empilable.

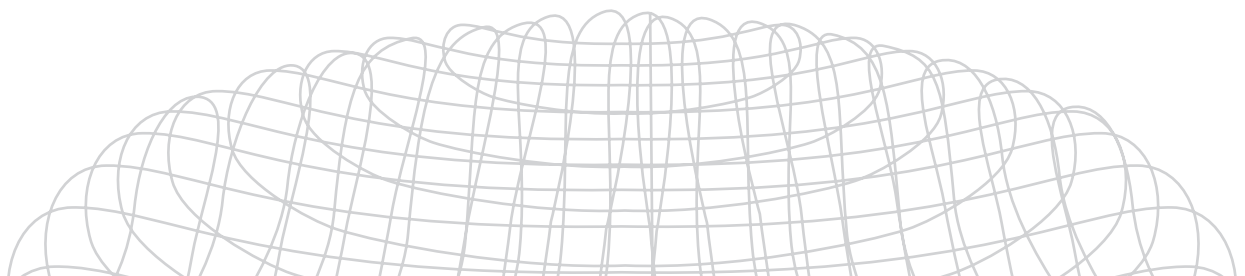
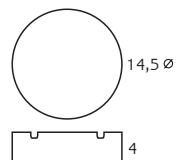

CENICEROS DE PARED

WALL ASHTRAYS

CENDRIERS MUR

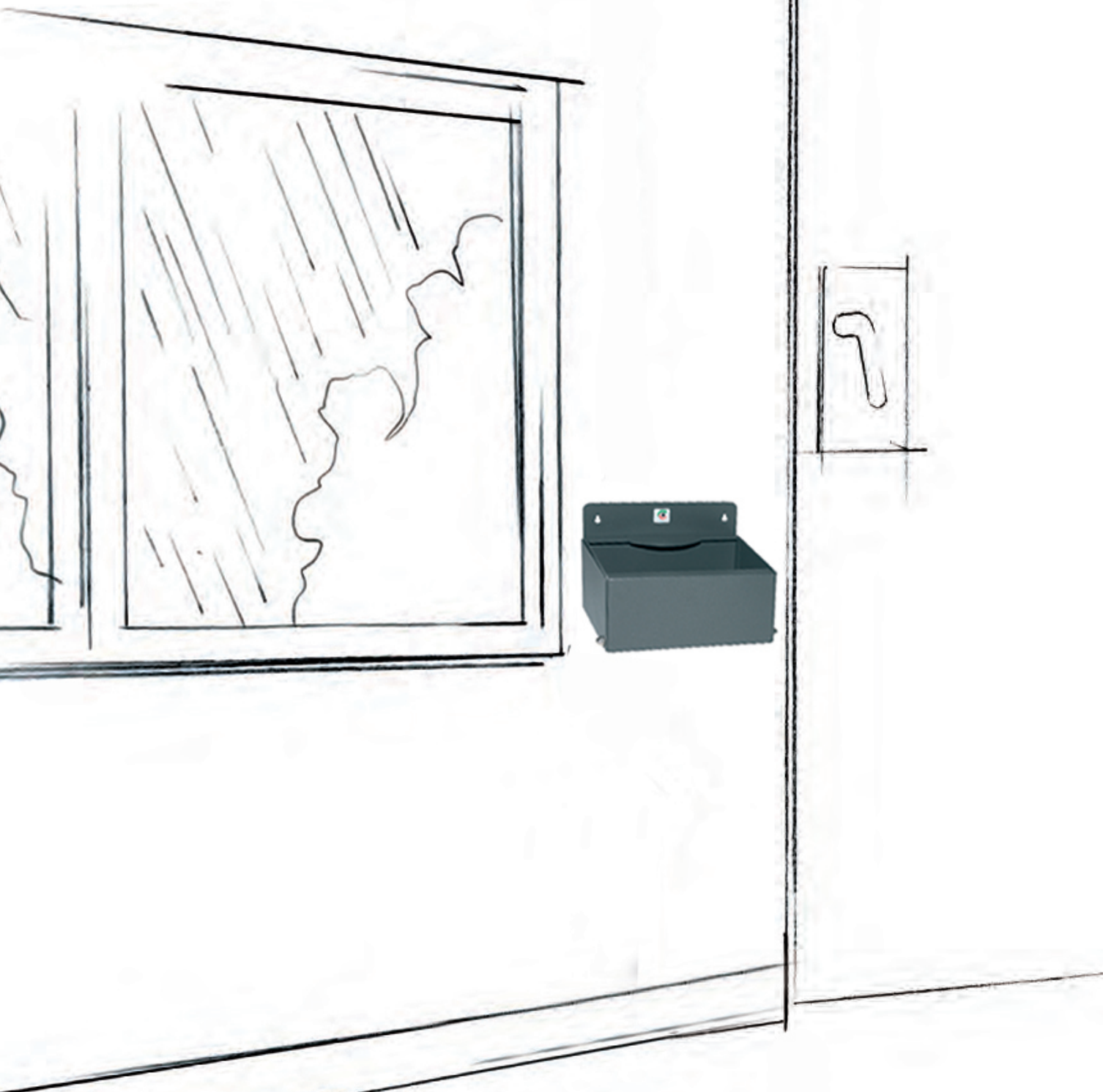

S-50

Cenicero de Pared
Colores: Negro, Grafito.

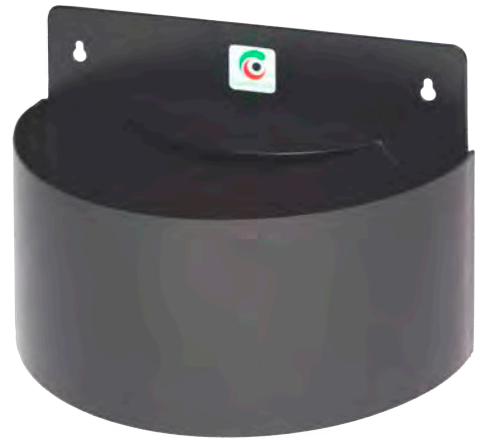
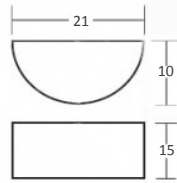

S-51

Cenicero metálico de pared.
Colores: Negro, Grafito.

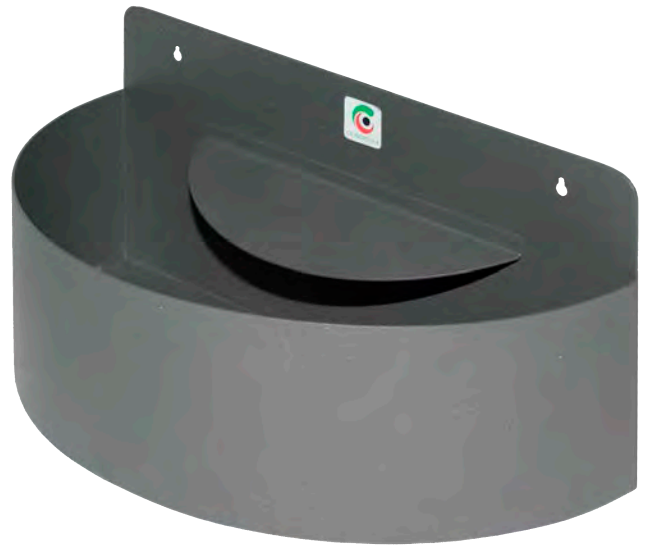
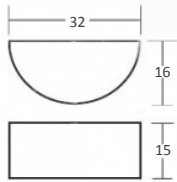

S-52

Cenicero metálico de pared.
Colores: Negro, Grafito.

