

# resol



págs. 4 - 133



págs. 134 - 151



págs. 152 - 163



págs. 164 - 233



págs. 234 - 261



págs. 262-295





# resol around the world



# resol

Más de 50 años compartiendo momentos, con la gama más extensa, los mejores precios y la máxima garantía.

More than 50 years sharing moments, with the most extensive range of products, the best prices and the best guarantee.

Plus de 50 ans partageant des moments, avec la plus large gamme, les meilleurs prix et la meilleure garantie.

[www.resol.es](http://www.resol.es) · [www.vilagrasa.com](http://www.vilagrasa.com)



resol blog



facebook





Resol instalaciones es el catálogo de RESOL especializado en el mundo de la hostelería y las colectividades.

Nuestra amplia gama de productos, permite crear ambientes adecuados y únicos para hoteles, restaurantes, cafeterías, corporaciones, así como en los espacios destinados a eventos, tales como centros de banquetes y convenciones.

El diseño, la calidad, la durabilidad, la funcionalidad, la estética y la competitividad son las características principales que abanderan a nuestros productos.

Nuestra misión pasa por la innovación continua, la calidad y la eficacia en el servicio orientado a los profesionales de la hostelería y las colectividades.

Resol facilities is the catalogue of RESOL specialized in the hotel and contract industry.

Our wide range of products, allows the creation of unique and optimal environments for hotels, restaurants, cafes, corporations, as well as for spaces dedicated to events such as banquets and conventions centers.

Design, quality, durability, functionality, aesthetics and competitive price are the main features that differentiate our products.

Our mission is based on continuous innovation, quality and effective service oriented to professionals in the hotel and contract industries.

RESOL Installations est le catalogue spécialisé de RESOL dans le secteur de l'hôtellerie et des collectivités.

Notre large gamme de produits, permet la création d'environnements uniques et fonctionnels pour des hôtels, restaurants, cafés, corporations, ainsi que des espaces destinés aux événements tels que centres de banquetes et conventions.

Le design, la qualité, la durabilité, la fonctionnalité, l'esthétique et les prix compétitifs sont les principales caractéristiques qui représentent nos produits.

Notre mission est l'innovation continue, la qualité et l'efficacité dans un service orienté aux professionnels de l'hôtellerie et les collectivités.







## Distinct design at everyday prices

Barcelona Dd es una marca que se está consolidando como uno de los referentes en el mercado de mobiliario de diseño y es la apuesta de valor de **Resol**.

Bajo el lema "Distinct design at everyday prices", Barcelona Dd ofrece mobiliario con un alto componente de diseño, fabricado principalmente en fibra de vidrio y polipropileno, en combinación con otros materiales como el aluminio, a precios muy competitivos.

Para que esto sea posible, Barcelona Dd se apoya en los siguientes ejes estratégicos:

- Un equipo creativo formado por diseñadores de vanguardia que firman nuestros productos.
- Un parque industrial muy potente que integra un proceso propio de diseño, desarrollo y producción de nuevos productos.
- La utilización del sistema de inyección de plástico asistido por gas en el proceso productivo de los productos inyectados en fibra de vidrio con PP.

Barcelona Dd is a brand which is establishing itself as one of the leading brands in design furniture and it's the most ambitious stake of **Resol** for the future.

Under the slogan "Distinct design at everyday prices", Barcelona Dd offers stylish furniture made mainly in fiberglass and polypropylene, in combination with other materials as aluminium at highly competitive prices. In order to make it possible, Barcelona Dd is based on the following strategic pillars:

- A creative team made up of cutting-edge designers who develop our products.
- Consolidated industrial operations that integrate in-house processes of design, development and manufacturing of new products.
- The use of gas-injection technology in the manufacturing process of those products injected in fiberglass with PP.

Barcelona Dd est une marque qui s'affirme comme une référence sur le marché du mobilier design et constitue le défi ambitieux de **Resol**.

Avec le slogan "Distinct design at every day prices", Barcelona Dd propose un mobilier avec une composante créative élevée, conçu principalement en fibre de verre et polypropylène en combinaison avec des autres matériaux comme l'aluminium, avec des prix très compétitifs. Pour que cela soit possible, Barcelona Dd se base sur les axes stratégiques suivants:

- Une équipe créative formée de designers d'avant-garde qui développe nos produits.
- Un parc industriel très puissant intégrant un processus propre de conception, de développement et de production de nouveaux produits.
- L'utilisation du système d'injection de plastique assisté par gaz lors du processus productif avec ces produits injectés en fibre de verre et PP.

resol





# Barcelona

# Dd

## Sillas Chairs Chaises

Skin 4 patas .....	8
Skin con brazos 4 patas .....	9
Skin patín .....	12
Skin con brazos patín .....	13
Skin araña .....	16
Skin con brazos araña .....	17
Skin taburete patín .....	20
Skin bancada .....	22
Skin carro porta sillas .....	24
Skin varilla unión sillas .....	24
Skin mesa auxiliar .....	24
Fiona .....	26
New Fiona con brazos .....	28
Fiona con brazos .....	30
Fiona combinaciones materiales .....	31
Fiona convenciones .....	32
Beekat .....	34
Beekat con brazos .....	35
Kat .....	38
Kat con brazos .....	39
Netkat .....	40
Netkat con brazos .....	41
Peach .....	44
Carla .....	46
Lama .....	48
Lama con brazos .....	49
Trama .....	52
Trama con brazos .....	53
Gina .....	56
Gina con brazos .....	57

Lisboa .....	60
Lisboa con brazos .....	62
Lisboa Ignifuga .....	63
Spot .....	64
Neutra .....	66
Julia .....	68
Pole deluxe .....	70
Pole .....	71
Moon .....	74
Sun .....	75
Barcino taburete .....	84
Rita .....	114
Julieta .....	116

## Tumbona Sunlounger Chaise longue

Barcino .....	88
---------------	----

## Sillón / Sofá Chair / Sofa Fauteuil / Canapé

Barcino Sofá .....	90
Barcino Sillón .....	91
Click-Clack Sofá .....	120
Click-Clack Sillón .....	121
Bob Sofá .....	126
Bob Sillón .....	127

## Mesas Tables Tables

Barcino mesa rectangular .....	78
Barcino compact mesa apilable .....	79
Barcino mesa apilable .....	80
Barcino mesa pie central .....	82
Barcino mesa pie central redonda .....	83
Barcino mesa pie central alto .....	86
Barcino mesa cubitera .....	87
Barcino coffee table .....	91
Vela S .....	94
Vela M .....	95
Vela L .....	96
Net .....	98
Point .....	100
Sputnik pie central simple .....	102
Sputnik pie central alto .....	104
Sputnik pie central doble .....	105
Space .....	108
New Dessa .....	109
New Flash .....	112
Julieta .....	117
Click-clack compact m. centro .....	122
Click-clack compact m. auxiliar .....	122
Click-clack mesa de centro .....	123
Click-clack mesa auxiliar .....	123
Bob mesa reposapiés .....	127

## Textil Textile Textile

Seat Pad .....	130
Textil Barcelona Dd .....	131



# Barcelona Dd

## Barcelona Dd apuesta por el diseño

Barcelona Dd nace con la voluntad de crear un espacio en el que la creatividad pueda fluir con plena espontaneidad. Permite que los diseñadores se expresen con el máximo de libertad para aportar al mundo objetos útiles, prácticos, novedosos y bellos.

Diseñadores como **Josep Llusà** o **Joan Gaspar** articulan lenguajes francamente diferenciados, aportando a Barcelona Dd una creatividad fresca y renovadora y el rigor de los creadores experimentados.

Barcelona Dd apuesta por el diseño como factor de diferenciación y competitividad clave. Esta inquietud le lleva a participar y promover diferentes acciones entorno a este eje. Entre ellas destaca su pertenencia a **RED**, Asociación de Empresas Españolas de Diseño, integrada por reconocidas compañías del sector.

**Red** ASOCIACIÓN  
DE EMPRESAS  
DE DISEÑO  
ESPAÑOL

A N I E M E



### Joan Gaspar

Contemporaneidad, diseño poco estridente, con el máximo discurso posible y, sobre todo, simple, muy simple.

Contemporary, discrete design, with as much dialogue as possible, and above all simple, very simple.

Contemporanéité, design peu voyant, qui vous parle et, surtout, simple, très simple.



### Josep Llusà

La silla perfecta existe. Está hecha de materiales inoxidables y ligeros, como el plástico o el aluminio. Es cómoda, apilable, económica, resistente y además bella.

The perfect chair exists. It is made of stainless and lightweight materials, such as plastic or aluminium. It is comfortable, stackable, affordable, resistant and furthermore beautiful.

La chaise parfaite existe. Elle est fabriquée avec des matériaux inoxydables et faciles à entretenir, soit plastique ou aluminium. Elle est pratique, empilable, économique, résistante et en plus, jolie.

**Barcelona Dd commits to design**

Barcelona Dd is born with the desire to create a space where creativity flows with full spontaneity. It allows the designers to express themselves freely to present to the world useful, practical and beautiful, vanguard objects.

Designers like Josep Llusca or Joan Gaspar transmit a variety of messages, contributing to Barcelona Dd's refreshing creativity, by respecting the rigor of experienced creators.

Barcelona Dd firmly believes that design is a key factor of differentiation and competitiveness. This conviction translates into the participation and promotion of different actions around this idea. Among these activities is its involvement with the Association of Spanish Companies of Design (RED), integrated by recognized companies of the industry.

**Barcelona Dd s'engage pour le design**

Barcelona Dd naît avec la volonté de créer un espace dans lequel la créativité coule avec une plénitude de spontanéité. Il permet aux créateurs de s'exprimer avec un maximum de liberté afin de présenter au monde des objets utiles, pratiques, innovatifs et beaux.

Des créateurs comme Josep Llusca ou Joan Gaspar font passer chacun son message à sa manière, en apportant à Barcelona Dd une créativité fraîche et du renouvellement, tout en respectant la rigueur des créateurs expérimentés.

Barcelona Dd croit fermement que le design est un facteur clé de différenciation et de compétitivité. Cette conviction se matérialise dans la participation et la promotion des différentes actions autour de cette idée. Une de ces activités est la participation dans l'Association des entreprises espagnoles de design (RED), intégrée par des entreprises reconnues de l'industrie.

**Premios / Awards / Prix**



**PEACH ARMCHAIR**

Winner IIDA/HD Product Design Competition 2011  
Las Vegas, USA



**TRAMA CHAIR AND ARMCHAIR**

Winner IIDA/HD Product Design Competition 2011  
Las Vegas, USA



**NETKAT CHAIR AND ARMCHAIR**

Award of Excellence IIDA/HD Product Design Competition 2012  
Las Vegas, USA



**BEEKAT CHAIR AND ARMCHAIR**

Platinum Award MIFF 2013  
Kuala Lumpur, Malaysia



**VELA TABLE**

Award of Excellence IIDA/HD Product Design Competition 2014  
Las Vegas, USA



Interior Innovation Award 2014 Winner  
Cologne, Germany



**CLICK-CLACK SET**

Platinum Award MIFF 2014  
Kuala Lumpur, Malaysia



silla 4 patas / 4-legs chair / chaise 4 pieds

# skin

DESIGNED BY JOSEP LLUSCÀ

Barcelona Dd

novedad  
new nouveauté

Tapizado Barcelona  
Dd disponible, pag. 131.

Barcelona Dd Upholstered  
available, pag. 131.

Revêtement Barcelona  
Dd disponible, pag. 131.



Silla cuatro patas para uso interior. Carcasa inyectada en fibra de vidrio y PP. Estructura de acero pintado blanco o antracita. Apilable. Opcional: mesa auxiliar de compacto fenólico. Peso neto 4,91 kg.

Four legs chair for indoor use. Seat injected with fiberglass and PP. Structure made of steel with white or anthracite finishing. Stackable. Optional: phenolic side table. Net weight 4,91 kg (10,82 lb).

Chaise 4 pieds pour usage intérieur. Siège injecté en fibre de verre et PP. Structure en acier peint blanc ou anthracite. Empilable. Optionnel: Table auxiliaire en résine phénolique. Poids net 4,91 kg.

Units STD	Packaging Dimensions (cm)	m3/ pack	NW Unit (kg)	Units Container 20'	Units Container 40'	Units Container HC	Units Trayler (70m3)	Units Truck 100m3
2	66,1x60,1x90	0,357	4,91	138	304	304	436	562
4	74,2x51,7x96,1	0,372	4,91	176	400	-	528	-
25	98x58x220	1,25	4,91	600	1.350	1.350	-	-

**W** 51,7 x **L** 55,3 x **H** 77,7 / **Hs** 43 cm  
**W** 20.35 x **L** 21.77 x **H** 30.59 / **Hs** 16.93 in



Blanco  
White  
Blanc



Gris oscuro  
Dark grey  
Gris foncé



Chocolate  
Chocolate  
Chocolat



Negro  
Black  
Noir

**W:** ancho / width / largeur **L:** largo / length / longueur **H:** altura / height / hauteur **Hs:** altura asiento / seat height / hauteur du siège

silla con brazos 4 patas / 4-legs armchair / fauteuil 4 pieds

novedad  
new nouveauté

# skin

DESIGNED BY JOSEP LLUSCA

Tapizado Barcelona  
Dd disponible, pag. 131.

Barcelona Dd Upholstered  
available, pag. 131.

Revêtement Barcelona  
Dd disponible, pag. 131.



Barcelona Dd

Silla con brazos cuatro patas para uso interior. Carcasa inyectada en fibra de vidrio y PP. Estructura de acero pintado blanco o antracita con brazos. Apilable. Peso neto 5,51 kg.

Four legs chair for indoor use. Seat injected with fiberglass and PP. Structure made of steel with white or anthracite finishing. Stackable. Net weight 5,51 kg (12.15 lb).

Fauteuil 4 pieds pour usage intérieur. Siège injecté en fibre de verre et PP. Structure en acier peint blanc ou anthracite. Empilable. Poids net 5,51 kg.

Units STD	Packaging Dimensions (cm)	m3/ pack	NW Unit (kg)	Units Container 20'	Units Container 40'	Units Container HC	Units Trayler (70m3)	Units Truck 100m3
2	66,7x60,1x90	0,357	5,51	138	304	304	436	562
4	73,7x60,7x96,9	0,433	5,51	176	400	-	528	-
25	98x58x220	1,25	5,51	600	1.350	1.350	-	-

**W** 56,2 x **L** 55,3 x **H** 77,7 / **Ha** 65,5 / **Hs** 43 cm

**W** 22.13 x **L** 21.77 x **H** 30.59 / **Ha** 25,78 / **Hs** 16.93 in



4 u.



Blanco  
White  
Blanc



Gris oscuro  
Dark grey  
Gris foncé



Chocolate  
Chocolate  
Chocolat



Negro  
Black  
Noir

**W:** ancho / width / largeur **L:** largo / length / longueur **H:** altura / height / hauteur **Hs:** altura asiento / seat height / hauteur du siège











silla patín / sled-base chair / chaise patin

# skin

DESIGNED BY JOSEP LLUSCA

Barcelona Dd

novedad  
new nouveauté

Tapizado Barcelona  
Dd disponible, pag. 131.

Barcelona Dd Upholstered  
available, pag. 131.

Revêtement Barcelona  
Dd disponible, pag. 131.



Silla patín para uso interior. Carcasa inyectada en fibra de vidrio y PP. Estructura de acero cromado o pintado blanco. Apilable. Peso neto: 6,31 kg.

Sled-base chair for indoor use. Seat injected with fiberglass and PP. Structure made of steel with chrome or white finishing. Stackable. Net weight 6,31 kg (13.91 lb).

Chaise patin pour usage intérieur. Siège injecté en fibre de verre et PP. Structure en acier peint blanc ou chromé. Empilable. Poids net 6,31 kg.

Units STD	Packaging Dimensions (cm)	m3/ pack	NW Unit (kg)	Units Container 20'	Units Container 40'	Units Container HC	Units Trayler (70m3)	Units Truck 100m3
2	66,1x60,1x90	0,357	6,31	69	152	152	218	281
4	73,7x60,7x96,9	0,433	6,31	176	400	-	528	-

**W** 56 x **L** 54,4 x **H** 77,6 / **Hs** 43 cm  
**W** 22.05 x **L** 21.42 x **H** 30.55 x **Hs** 16.93 in



4 u.



Blanco  
White  
Blanc



Gris oscuro  
Dark grey  
Gris foncé



Chocolate  
Chocolate  
Chocolat



Negro  
Black  
Noir

**W:** ancho / width / largeur **L:** largo / length / longueur **H:** altura / height / hauteur **Hs:** altura asiento / seat height / hauteur du siège

silla con brazos patín / sled-base armchair / fauteuil patin

novedad  
new nouveauté

# skin

DESIGNED BY JOSEP LLUSCA

Tapizado Barcelona Dd disponible, pag. 131.  
Barcelona Dd Upholstered available, pag. 131.  
Revêtement Barcelona Dd disponible, pag. 131.



Barcelona Dd

Silla con brazos patín para uso interior. Carcasa inyectada en fibra de vidrio y PP. Estructura de acero cromado o pintado blanco. Apilable. Peso neto: 7,11 kg.

Sled-base armchair for indoor use. Seat injected with fiberglass and PP. Structure made of steel with chrome or white finishing. Stackable. Net weight 7,11 kg (15.67 lb).

Chaise patin pour usage intérieur. Siège injecté en fibre de verre et PP. Structure en acier peint blanc ou chromé. Empilable. Poids net 7,11 kg.

Units STD	Packaging Dimensions (cm)	m3/pack	NW Unit (kg)	Units Container 20'	Units Container 40'	Units Container HC	Units Traylor (70m3)	Units Truck 100m3
2	66,1x60,1x90	0,357	7,11	69	152	152	218	281
4	73,7x60,7x96,9	0,433	7,11	176	400	-	528	-

**W** 56 x **L** 54,4 x **H** 77,6 / **Ha** 65,5 / **Hs** 43 cm  
**W** 22.05 x **L** 21.42 x **H** 30.55 / **Ha** 25.78 / **Hs** 16.93 in



4 u.



Blanco  
White  
Blanc



Gris oscuro  
Dark grey  
Gris foncé



Chocolate  
Chocolate  
Chocolat



Negro  
Black  
Noir

**W:** ancho / width / largeur **L:** largo / length / longueur **H:** altura / height / hauteur **Hs:** altura asiento / seat height / hauteur du siège **Ha:** altura brazo / armrest height / hauteur de l'accoudoir









silla araña / spider chair / chaise araignée

# skin

DESIGNED BY JOSEP LLUSCA

Barcelona Dd

novedad  
new nouveauté



Tapizado Barcelona  
Dd disponible, pag. 131.

Barcelona Dd Upholstered  
available, pag. 131.

Revêtement Barcelona  
Dd disponible, pag. 131.

Silla araña para uso interior. Carcasa inyectada en fibra de vidrio y PP. Estructura de acero cromado o pintado blanco. Peso neto 6,87 kg.

Spider chair for indoor use. Seat injected with fiberglass and PP. Structure made of steel with chrome or white finishing. Net weight 6,87 kg (15.15 lb).

Chaise 4 pieds araignée pour usage intérieur. Siège injecté en fibre de verre et PP. Structure en acier peint blanc ou chromé. Poids net 6,87 kg.

Units STD	Packaging Dimensions (cm)	m3/ pack	NW Unit (kg)	Units Container 20'	Units Container 40'	Units Container HC	Units Trayler (70m3)	Units Truck 100m3
2	66,1x60,1x90	0,357	6,87	69	152	152	218	281

**W** 49 x **L** 53,4 x **H** 77,5 / **Hs** 43,7 cm  
**W** 19.29 x **L** 21.02 x **H** 30.51 / **Hs** 17.20 in



Blanco  
White  
Blanc



Gris oscuro  
Dark grey  
Gris foncé



Chocolate  
Chocolate  
Chocolat



Negro  
Black  
Noir

**W:** ancho / width / largeur   **L:** largo / length / longueur   **H:** altura / height / hauteur   **Hs:** altura asiento / seat height / hauteur du siège



silla con brazos araña / spider armchair / fauteuil araignée

novedad  
new nouveauté

# skin

DESIGNED BY JOSEP LLUSCÀ

Tapizado Barcelona Dd disponible, pag. 131.  
Barcelona Dd Upholstered available, pag. 131.  
Revêtement Barcelona Dd disponible, pag. 131.



Barcelona Dd

Silla con brazos araña para uso interior. Carcasa inyectada en fibra de vidrio y PP. Estructura de acero cromado o pintado blanco. Peso neto: 7,48 kg.

Spider armchair for indoor use. Seat injected with fiberglass and PP. Structure made of steel with chrome or white finishing. Net weight 7,48 kg (16.49 lb).

Fauteuil 4 pieds araignée pour usage intérieur. Siège injecté en fibre de verre et PP. Structure en acier peint blanc ou chromé. Poids net 7,48 kg.

Units STD	Packaging Dimensions (cm)	m3/ pack	NW Unit (kg)	Units Container 20'	Units Container 40'	Units Container HC	Units Trayler (70m3)	Units Truck 100m3
2	66,1x60,1x90	0,357	7,48	69	152	152	218	281

**W** 56x **L** 53,4 x **H** 77,5 / **Ha** 65,5 / **Hs** 43,7 cm

**W** 22.05 x **L** 21.02 x **H** 30.51 / **Ha** 25.79 / **Hs** 17.20 in



Blanco  
White  
Blanc



Gris oscuro  
Dark grey  
Gris foncé



Chocolate  
Chocolate  
Chocolat



Negro  
Black  
Noir

**W:** ancho / width / largeur **L:** largo / length / longueur **H:** altura / height / hauteur **Hs:** altura asiento / seat height / hauteur du siège **Ha:** altura brazo / armrest height / hauteur de l'accoudoir









taburete patín / sled-base stool / tabouret patin

novedad  
new nouveauté

# skin

DESIGNED BY JOSEP LLUSCA

Barcelona Dd

Tapizado Barcelona  
Dd disponible, pag. 131.

Barcelona Dd Upholstered  
available, pag. 131.

Revêtement Barcelona  
Dd disponible, pag. 131.



Taburete patín para uso interior. Carcasa inyectada en fibra de vidrio y PP.  
Estructura de acero cromado o pintado blanco. Peso neto: 7,45 kg.

Sled-base stool for indoor use. Seat injected with fiberglass and PP. Structure made  
of steel with chrome or white finishing. Net weight 7,45 kg (16.42 lb).

Tabouret patin pour usage intérieur. Siège injecté en fibre de verre et PP. Structure  
en acier peint blanc ou chromé. Empilable. Poids net 7,45 kg.

Units STD	Packaging Dimensions (cm)	m3/ pack	NW Unit (kg)	Units Container 20'	Units Container 40'	Units Container HC	Units Trayler (70m3)	Units Truck 100m3
2	60x56x107,5	0,361	7,45	80	176		208	
4	60x56x107,5	0,361	7,45	160	352		416	

**W** 52 x **L** 54,5 x **H** 94,5 / **Hs** 73 cm

**W** 20.47 x **L** 21.46 x **H** 37.20 / **Hs** 28.74 in



Blanco  
White  
Blanc



Gris oscuro  
Dark grey  
Gris foncé



Chocolate  
Chocolate  
Chocolat



Negro  
Black  
Noir

**W:** ancho / width / largeur **L:** largo / length / longueur **H:** altura / height / hauteur **Hs:** altura asiento / seat height / hauteur du siège





bancada / bench seating / banquette

# skin

DESIGNED BY JOSEP LLUSCÀ

novedad  
new nouveauté

Barcelona Dd



Tapizado Barcelona  
Dd disponible, pag. 131.

Barcelona Dd Upholstered  
available, pag. 131.

Revêtement Barcelona  
Dd disponible, pag. 131.

Bancada para uso interior. Carcasa inyectada en fibra de vidrio y PP. Estructura de acero pintado blanco. Los brazos y la mesa auxiliar son opcionales.

Bench seating. Seat and back injected with fiberglass and PP. Structure and legs made of steel with white or anthracite finishing. Armrests and auxiliary table are optional.

Banquette pour usage intérieur. Siège injecté en fibre de verre et PP. Structure en acier peint blanc. Les accoudoirs et la table auxiliaire sont optionnels.

## Combinaciones / Combinations / Combinaisons:

3 plazas con brazos / 3 places armchair / 3 places avec accoudoirs

**W** 175,36 x **L** 54,14 x **H** 77,6 / **Hs** 46,3 / **Ha** 65,6 cm

**W** 69.04 x **L** 21.31 x **H** 30.55 / **Hs** 18.23 / **Ha** 25,83 in  
23,75 kg (52.36 lb)

3 plazas + mesa aux. / 3 places + aux. table / 3 places + aux. table

**W** 232 x **L** 54,14 x **H** 77,6 / **Hs** 46,3 cm

**W** 91.34x **L** 21.31 x **H** 30.55 / **Hs** 18.23 in  
27,21 kg (59.99 lb)

4 plazas / 4 places / 4 places

**W** 232 x **L** 54,14 x **H** 77,6 / **Hs** 46,3 cm

**W** 91.34 x **L** 21.31 x **H** 30.55 / **Hs** 18.23 in  
28,54 kg (62.92 lb)

2 plazas + mesa aux. / 2 places + aux. table / 2 places + aux. table

**W** 175,4 x **L** 54,14 x **H** 77,6 / **Hs** 46,3 cm

**W** 69,04 x **L** 21.31 x **H** 30.55 / **Hs** 18.23 in  
19,28 kg (62.92 lb)

Consultar Departamento Comercial para más combinaciones de silla + mesa auxiliar disponibles.

Ask Sales Department for more chair + auxiliary table available combinations.

Consulter le Département Commercial pour plusieurs combinaisons de chaise+tables auxiliaires disponibles.

**W:** ancho / width / largeur **L:** largo / length / longueur **H:** altura / height / hauteur **Hs:** altura asiento / seat height / hauteur du siège





carro porta sillas / trolley for chairs / chariot porte-chaises

skin

novedad  
new nouveauté

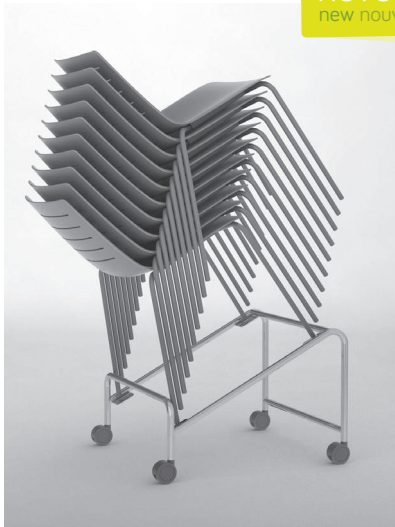

Carro de acero para sillas apilables Skin.  
Trolley for Skin stackable chairs made in steel.  
Chariot en acier pour les chaises empilables Skin.

W 58,9 x L 38 cm  
W 23.19 x L 14.96 in  
13,10 kg (28.88 lb)

varilla unión sillas / rod to link accessory / branche union chaises

skin

novedad  
new nouveauté

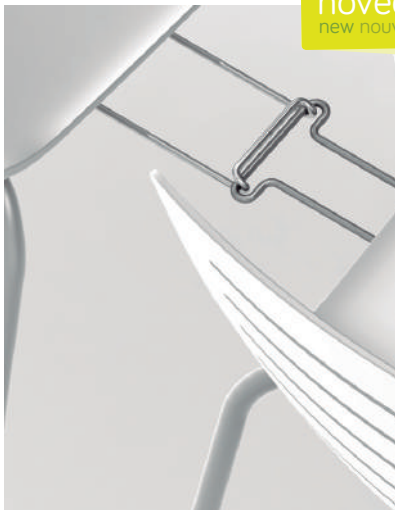

Varilla unión sillas para convenciones y eventos en acero cromado.  
Rod to link accessory for chairs for conventions and events in chrome steel.  
Branche union chaises pour conventions et événements en acier chromé.

mesa auxiliar / auxiliary table / table auxiliaire

skin

novedad  
new nouveauté



Mesa auxiliar izquierda/derecha para convenciones. Conexión para la silla en acero pintado negro (RAL 9011). Altura mesa 74,7 cm.

Right/left hand side table for conventions. Joint for the chair in black painted steel (RAL 9011). Table height 74,7 cm (29.41 in).

Table auxiliaire gauche/droite pour conventions. Jointure pour chaise en acier peint noir (RAL 9011). Hauteur table 74,7 cm.





silla / chair / chaise

# fiona

DESIGNED BY JOSEP LLUSCÀ

Barcelona Dd



Tapizado Barcelona Dd disponible, pag. 132.  
 Barcelona Dd Upholstered available, pag. 132.  
 Revêtement Barcelona Dd disponible, pag. 132.

ASOCIADO N°01684  
**AIDIMA**  
 INSTITUTO TECNOLÓGICO  
 MUEBLE, MADERA, EMBALAJE Y AFINES

Silla para uso interior y exterior. Inyectada con fibra de vidrio y PP. Apilable. Protección UV. Peso neto silla 4,02 kg. Opcional: Pinza enlace de sillas para convenciones y eventos inyectada en policarbonato translúcido.

Chair for indoor and outdoor use. Injected with fiberglass and PP. Stackable. UV protection. Chair's net weight 4,02 kg (8.86 lb). Optional: Clamp connection of chairs for conventions and events injected in translucent polycarbonate.

Chaise pour usage intérieur et extérieur. Injectée avec fibre de verre et PP. Empilable. Protection UV. Poids net chaise 4,02 kg. Optionnel: Pince de jonction des chaises pour conventions et événements injectée en polycarbonate translucide.

Fiona Test Certificates:  
 AIDIMA UNE EN 15373:07 General Public Use / UNE EN 1728:01

Units STD	Packaging Dimensions (cm)	m3/ pack	NW Unit (kg)	Units Container 20'	Units Container 40'	Units Container HC	Units Trayler (70m3)	Units Truck 100m3
2	66,1x60,1x90	0,357	4,02	138	304	304	436	562
4	73,7x52x97,5	0,41	4,02	280	568	568	632	808
24	98x58x218	1,239	4,02	576	1.152	1.152	1.296	1.392

**W** 48 x **L** 54 x **H** 80 x **Hs** 47,5 cm  
**W** 18.89 x **L** 21.26 x **H** 31.50 x **Hs** 18.70 in



Blanco  
White  
Blanc



Verde oliva  
Olive green  
Vert olive



Chocolate  
Chocolate  
Chocolat



Negro  
Black  
Noir



Arena  
Sand  
Sable



Gris oscuro  
Dark grey  
Gris foncé

**W:** ancho / width / largeur **L:** largo / length / longueur **H:** altura / height / hauteur **Hs:** altura asiento / seat height / hauteur du siège





silla con brazos / armchair / fauteuil

novedad  
new nouveauté

Barcelona Dd

# new fiona

DESIGNED BY JOSEP LLUSCÀ



Tapizado Barcelona  
Dd disponible, pag. 132.

Barcelona Dd Upholstered  
available, pag. 132.

Revêtement Barcelona  
Dd disponible, pag. 132.

Silla con brazos para uso interior y exterior. Inyectada con fibra de vidrio y PP. Apilable. Protección UV. Peso neto 4,3 kg. Opcional: Pinza enlace de sillas para convenciones y eventos inyectada en policarbonato translúcido.

Armchair for indoor and outdoor use. Seat and back injected with fiberglass and PP. Stackable. UV protection. Net weight 4,3 kg. (9.08 lb). Optional: Clamp connection of chairs for conventions and events injected in translucent polycarbonate.

Fauteuil pour usage intérieur et extérieur. Injecté avec fibre de verre et PP. Empilable. Protection UV. Poids net 4,3 kg. Optionnel: Pince de jonction des chaises pour conventions et événements injectée en polycarbonate translucide.

Units STD	Packaging Dimensions (cm)	m3/ pack	NW Unit (kg)	Units Container 20'	Units Container 40'	Units Container HC	Units Trayler (70m3)	Units Truck 100m3
2	66,1x60,1x90	0,357	4,3	138	304	304	436	562
4	73,7x60,7x97,5	0,37	4,3	216	456	456	528	768
20	98x58x220	1,25	4,3	480	960	960	1.080	1.160

**W** 52,3 x **L** 52 x **H** 80,5 x **Hs** 46,1 cm  
**W** 20.60 x **L** 20.48 x **H** 31.70 x **Hs** 18.15 in



Blanco  
White  
Blanc



Verde oliva  
Olive green  
Vert olive



Chocolate  
Chocolate  
Chocolat



Arena  
Sand  
Sable



Gris oscuro  
Dark grey  
Gris foncé



Negro  
Black  
Noir

**W:** ancho / width / largeur **L:** largo / length / longueur **H:** altura / height / hauteur **Hs:** altura asiento / seat height / hauteur du siège **Ha:** altura brazo / armrest height / hauteur de l'accoudoir





silla con brazos / armchair / fauteuil

# fiona

DESIGNED BY JOSEP LLUSCÀ

Barcelona Dd



Tapizado Barcelona Dd disponible, pag. 132.  
Barcelona Dd Upholstered available, pag. 132.  
Revêtement Barcelona Dd disponible, pag. 132.

SOCIADO N° 01684  
**AIDIMA**  
INSTITUTO TECNOLÓGICO  
MUEBLE, MADERA, EMBALAJE Y AFINES

Silla con brazos para uso interior y exterior. Inyectada con fibra de vidrio y PP. Apilable. Protección UV. Peso neto 4,75 kg. Opcional: Pinza enlace de sillas para convenciones y eventos inyectada en policarbonato translúcido.

Armchair for indoor and outdoor use. Seat and back injected with fiberglass and PP. Stackable. UV protection. Net weight 4,75 kg. (10.47 lb). Optional: Clamp connection of chairs for conventions and events injected in translucent polycarbonate.

Fauteuil pour usage intérieur et extérieur. Injecté avec fibre de verre et PP. Empilable. Protection UV. Poids net 4,75 kg. Optionnel: Pince de jonction des chaises pour conventions et événements injectée en polycarbonate translucide.

Fiona Armchair Test Certificates:  
AIDIMA UNE EN 15373:07 General Public Use / UNE EN 1728:01

Units STD	Packaging Dimensions (cm)	m <sup>3</sup> / pack	NW Unit (kg)	Units Container 20'	Units Container 40'	Units Container HC	Units Traylor (70m <sup>3</sup> )	Units Truck 100m <sup>3</sup>
2	66,1x60,1x90	0,357	4,75	138	304	304	436	562
4	73,7x60,7x97,5	0,42	4,75	216	456	456	528	768

**W** 58 x **L** 53 x **H** 81 x **Hs** 47,5 x **Ha** 67,7 cm  
**W** 22.83 x **L** 20.87 x **H** 31.89 x **Hs** 18.70 x **Ha** 26.65 in



7 u.



Blanco  
White  
Blanc



Chocolate  
Chocolate  
Chocolat



Negro  
Black  
Noir



Arena  
Sand  
Sable



Verde oliva  
Olive green  
Vert olive



Gris oscuro  
Dark grey  
Gris foncé

**W:** ancho / width / largeur **L:** largo / length / longueur **H:** altura / height / hauteur **Hs:** altura asiento / seat height / hauteur du siège **Ha:** altura brazo / armrest height / hauteur de l'accoudoir

combinación materiales / materials combination / combinaison materiaux

# fiona

DESIGNED BY JOSEP LLUSCA



Tapizado Barcelona  
Dd disponible, pag. 132.  
Barcelona Dd Upholstered  
available, pag. 132.  
Revêtement Barcelona  
Dd disponible, pag. 132.

Barcelona Dd

Silla para uso interior y exterior. Asiento inyectado con fibra de vidrio y PP. Respaldo inyectado en policarbonato translúcido. Apilable. Protección UV. Peso neto 5,30 kg. Opcional: Pinza enlace de sillas para convenciones y eventos inyectada en policarbonato translúcido.

Chair for indoor and outdoor use. Seat injected with fiberglass and PP. Backrest injected with translucent polycarbonate. Stackable. UV protection. Net weight 5,30 kg. (11.66 lb). Optional: Clamp connection of chairs for conventions and events injected in translucent polycarbonate.

Chaise pour usage intérieur et extérieur. Siège Injecté de fibre de verre et PP. Dossier injecté en polycarbonate translucide. Empilable. Protection UV. Poids net 5,30 kg. Optionnel: Pince de jonction des chaises pour conventions et événements injectée en polycarbonate translucide.

Units STD	Packaging Dimensions (cm)	m3/ pack	NW Unit (kg)	Units Container 20'	Units Container 40'	Units Container HC	Units Trayler (70m3)	Units Truck 100m3
2	66,1x60,1x90	0,357	5,30	138	304	304	436	562
4	73,7x52x97,5	0,41	5,30	280	568	568	632	808
24	98x58x218	1,239	5,30	576	1.152	1.152	1.296	1.392

**W** 48 x **L** 54 x **H** 80 x **Hs** 47,5 cm  
**W** 18.89 x **L** 21.26 x **H** 31.50 x **Hs** 18.70 in



10 u.



Respaldo translúcido/Asiento negro  
Translucent backrest/ Black seat  
Dossier translucide/Siège noir

**W:** ancho / width / largeur **L:** largo / length / longueur **H:** altura / height / hauteur **Hs:** altura asiento / seat height / hauteur du siège **Ha:** altura brazo / armrest height / hauteur de l'accoudoir



convenciones / conventions / conventions

# fiona

DESIGNED BY JOSEP LLUSCA

Barcelona Dd



Tapizado Barcelona Dd disponible, pag. 132.  
Barcelona Dd Upholstered available, pag. 132.  
Revêtement Barcelona Dd disponible, pag. 132.

Silla para uso interior y exterior. Inyectada con fibra de vidrio y PP. Apilable. Protección UV. Opcional: Mesa auxiliar izquierda/derecha para convenciones. Conexión para la silla en acero pintado negro (RAL 9011). Opcional: Pinza enlace de sillas, para convenciones y eventos, inyectada en policarbonato translúcido. Peso neto 5,75 kg.

Chair for indoor and outdoor use. Injected with fiberglass and PP. Stackable. UV protection. Optional: Right/left hand side table for conventions. Joint for the chair in black painted steel (RAL 9011). Optional: Clamp connection of chairs, for conventions and events, injected in translucent polycarbonate. Net weight 5,75 kg. (12.65 lb).

Chaise pour usage intérieur et extérieur. Injectée avec fibre de verre et PP. Empilable. Protection UV. Optionnel: Table auxiliaire gauche/droite pour conventions. Jointure pour chaise en acier peint noir (RAL 9011). Optionnel: Pince d'assemblage de chaises, pour conventions et événements, injectée en polycarbonate translucide. Poids net 5,75 kg.

Units STD	Packaging Dimensions (cm)	m3/ pack	NW Unit (kg)	Units Container 20'	Units Container 40'	Units Container HC	Units Trayler (70m3)	Units Truck 100m3
4	73,7x52x97,5	0,41	5,75	280	568	568	632	808
24	98x58x218	1,239	5,75	576	1.152	1.152	1.296	1.392

**W** 48 x **L** 54 x **H** 80 x **Hs** 47,5 x **Hd** 75 cm  
**W** 18.89 x **L** 21.26 x **H** 31.50 x **Hs** 18.70 x **Hd** 29.53 in



Blanco  
White  
Blanc



Chocolate  
Chocolate  
Chocolat



Verde oliva  
Olive green  
Vert olive



Negro  
Black  
Noir



Arena  
Sand  
Sable



Gris oscuro  
Dark grey  
Gris foncé



Respaldo translúcida/Asiento negro  
Translucent backrest/ Black seat  
Dossier translucide/Siège noir

**W:** ancho / width / largeur    **L:** largo / length / longueur    **H:** altura / height / hauteur    **Hs:** altura asiento / seat height / hauteur du siège  
**Ha:** altura brazo / armrest height / hauteur de l'accoudoir    **Hd:** altura escritorio / desk height / hauteur pupitre





silla / chair / chaise

# beekat

DESIGNED BY JOSEP LLUSCÀ

Barcelona Dd



ASOCIADO N°01684  
**AIDIMA**  
 INSTITUTO TECNOLÓGICO  
 MUEBLE, MADERA, EMBALAJE Y AFINES



Silla para uso interior y exterior. Inyectada en fibra de vidrio con PP mediante tecnología de moldeo asistida por gas. Apilable. Protección UV. Peso neto 3,70 kg.

Chair for indoor and outdoor use. Injected with fiberglass and PP using gas assisted injection moulding technology. UV protection. Stackable. Net weight 3,70 kg (8.16 lb).

Chaise pour usage intérieur et extérieur. Injectée avec fibre de verre et PP, en utilisant technologie de moulage assistée par gaz. Protection UV. Empilable. Poids net 3,70 kg.

Beekat Test Certificates:

AIDIMA UNE EN 15373:07 General Public Use / UNE EN 1728:01

Units STD	Packaging Dimensions (cm)	m3/ pack	NW Unit (kg)	Units Container 20'	Units Container 40'	Units Container HC	Units Traylor (70m3)	Units Truck 100m3
2	66,1x60,1x90	0,357	3,70	138	304	304	436	562
4	73,7x52x97,5	0,41	3,70	280	568	568	632	808
23	98x58x217	1,233	3,70	552	1.104	1.104	1.242	1.334

**W** 50,5 x **L** 55,5 x **H** 79 x **Hs** 47 cm  
**W** 19.88 x **L** 21.85 x **H** 31.10 x **Hs** 18.50 in



Blanco  
White  
Blanc



Rojo  
Red  
Rouge



Verde oliva  
Olive green  
Vert olive



Chocolate  
Chocolater  
Chocolat



Arena  
Sand  
Sable

**W:** ancho / width / largeur    **L:** largo / length / longueur    **H:** altura / height / hauteur    **Hs:** altura asiento / seat height / hauteur du siège    **Ha:** altura brazo / armrest height / hauteur de l'accoudoir

silla con brazos / armchair / fauteuil

# beekat

DESIGNED BY JOSEP LLUSCÀ



ASOCIADO N°01684  
**AIDIMA**  
 INSTITUTO TECNOLÓGICO  
 MUEBLE, MADERA, EMBALAJE Y AFINES



Barcelona Dd

Silla con brazos para uso interior y exterior. Inyectada en fibra de vidrio con PP mediante tecnología de moldeo asistida por gas. Apilable. Protección UV. Peso neto 4,20 kg.

Armchair for indoor and outdoor use. Injected with fiberglass and PP using gas assisted injection moulding technology. Stackable. UV protection. Net weight 4,20 kg (9.26 lb).

Fauteuil pour usage intérieur et extérieur. Injecté avec fibre de verre et PP, en utilisant technologie de moulage assistée par gaz. Empilable. Protection UV. Poids net 4,20 kg.

#### Beekat Armchair Test Certificates:

AIDIMA UNE EN 15373:07 General Public Use / UNE EN 1728:01

Units STD	Packaging Dimensions (cm)	m3/ pack	NW Unit (kg)	Units Container 20'	Units Container 40'	Units Container HC	Units Trayler (70m3)	Units Truck 100m3
2	66,1x60,1x90	0,357	4,20	138	304	304	436	562
4	73,7x60,7x97,5	0,41	4,20	216	456	456	528	768
23	98x58x217	1,233	4,20	552	1.104	1.104	1.242	1.334

**W** 56 x **L** 55,5 x **H** 79 x **Hs** 47 x **Ha** 65,5 cm

**W** 22.04 x **L** 21.85 x **H** 31.10 x **Hs** 18.50 x **Ha** 25.79 in



Blanco  
White  
Blanc



Rojo  
Red  
Rouge



Verde oliva  
Olive green  
Vert olive



Chocolate  
Chocolate  
Chocolat



Arena  
Sand  
Sable

**W:** ancho / width / largeur    **L:** largo / length / longueur    **H:** altura / height / hauteur    **Hs:** altura asiento / seat height / hauteur du siège    **Ha:** altura brazo / armrest height / hauteur de l'accoudoir











silla / chair / chaise

# kat

DESIGNED BY JOSEP LLUSCÀ

Barcelona Dd



ASOCIADO N°01684

**AIDIMA**  
INSTITUTO TECNOLÓGICO  
MUEBLE, MADERA, EMBALAJE Y AFINES

Silla para uso interior y exterior. Inyectada en fibra de vidrio con PP mediante tecnología de moldeo asistida por gas. Apilable. Protección UV. Peso neto 3,70 kg.

Chair for indoor and outdoor use. Injected with fiberglass and PP using gas assisted injection moulding technology. Stackable. UV protection. Net weight 3,70 kg (8.16 lb).

Chaise pour usage intérieur et extérieur. Injectée avec fibre de verre et PP, en utilisant technologie de moulage assistée par gaz. Empilable. Protection UV. Poids net 3,70 kg.

Kat Test Certificates:

AIDIMA UNE EN 15373:07 General Public Use / UNE EN 1728:01

Units STD	Packaging Dimensions (cm)	m3/ pack	NW Unit (kg)	Units Container 20'	Units Container 40'	Units Container HC	Units Trayler (70m3)	Units Truck 100m3
2	66,1x60,1x90	0,357	3,70	138	304	304	436	562
4	73,7x52x97,5	0,41	3,70	280	568	568	632	808
23	98x58x217	1,233	3,70	552	1.104	1.104	1.242	1.334

**W** 50,5 x **L** 55,5 x **H** 79 x **Hs** 47 cm  
**W** 19.82 x **L** 21.85 x **H** 31.10 x **Hs** 18.50 in



10 u.



Blanco  
White  
Blanc



Rojo  
Red  
Rouge



Verde oliva  
Olive green  
Vert olive



Chocolate  
Chocolate  
Chocolat



Arena  
Sand  
Sable

**W:** ancho / width / largeur **L:** largo / length / longueur **H:** altura / height / hauteur **Hs:** altura asiento / seat height / hauteur du siège

silla con brazos / armchair / fauteuil

# kat

DESIGNED BY JOSEP LLUSCÀ



Barcelona Dd

ASOCIADO N°01684

**AIDIMA**  
INSTITUTO TECNOLÓGICO  
MUEBLE, MADERA, EMBALAJE Y AFINES

Silla con brazos para uso interior y exterior. Inyectada en fibra de vidrio con PP mediante tecnología de moldeo asistida por gas. Apilable. Protección UV. Peso neto 4,20 kg.

Armchair for indoor and outdoor use. Injected with fiberglass and PP using gas assisted injection moulding technology. Stackable. UV protection. Net weight 4,20 kg (9.26 lb).

Fauteuil d'intérieur et extérieur. Injecté avec fibre de verre et PP, en utilisant technologie de moulage assistée par gaz. Empilable. Protection UV. Poids net 4,20 kg.

Kat Armchair Test Certificates:

AIDIMA UNE EN 15373:07 General Public Use / UNE EN 1728:01

Units STD	Packaging Dimensions (cm)	m3/ pack	NW Unit (kg)	Units Container 20'	Units Container 40'	Units Container HC	Units Trayler (70m3)	Units Truck 100m3
2	66,1x60,1x90	0,357	4,20	138	304	304	436	562
4	73,7x60,7x97,5	0,41	4,20	216	456	456	528	768
23	98x58x217	1,233	4,20	552	1.104	1.104	1.242	1.334

**W** 56 x **L** 55,5 x **H** 79 x **Hs** 47 x **Ha** 65,5 cm

**W** 22.04 x **L** 21.85 x **H** 31.10 x **Hs** 18.50 x **Ha** 25.79 in



10 u.



Blanco  
White  
Blanc



Rojo  
Red  
Rouge



Verde oliva  
Olive green  
Vert olive



Chocolate  
Chocolate  
Chocolat



Arena  
Sand  
Sable

**W:** ancho / width / largeur **L:** largo / length / longueur **H:** altura / height / hauteur **Hs:** altura asiento / seat height / hauteur du siège



silla / chair / chaise

# netkat

DESIGNED BY JOSEP LLUSCÀ

Barcelona Dd



ASOCIADO N°01684  
**AIDIMA**  
INSTITUTO TECNOLÓGICO  
MUEBLE, MADERA, EMBALAJE Y AFINES



Silla para uso interior y exterior. Inyectada en fibra de vidrio con PP mediante tecnología de moldeo asistida por gas. Apilable. Protección UV. Peso neto 3,60 kg.

Chair for indoor and outdoor use. Injected with fiberglass and PP using gas assisted injection moulding technology. Stackable. UV protection. Net weight 3,60 kg (7.93 lb).

Chaise d'intérieur et extérieur. Injectée avec fibre de verre et PP, en utilisant technologie de moulage assistée par gaz. Empilable. Protection UV. Poids net 3,60 kg.

Netkat Test Certificates:

AIDIMA UNE EN 15373:07 General Public Use / UNE EN 1728:01

Units STD	Packaging Dimensions (cm)	m3/ pack	NW Unit (kg)	Units Container 20'	Units Container 40'	Units Container HC	Units Traylor (70m3)	Units Truck 100m3
2	66,1x60,1x90	0,357	3,60	138	304	304	436	562
4	73,7x52x97,5	0,41	3,60	280	568	568	632	808
23	98x58x217	1,359	3,60	552	1.104	1.104	1.242	1.334

**W** 50,5 x **L** 55,5 x **H** 79 x **Hs** 47 cm  
**W** 19.82 x **L** 21.85 x **H** 31.10 x **Hs** 18.50 in



Blanco  
White  
Blanc



Verde oliva  
Olive green  
Vert olive



Chocolate  
Chocolate  
Chocolat



Negro  
Black  
Noir



Arena  
Sand  
Sable

**W:** ancho / width / largeur    **L:** largo / length / longueur    **H:** altura / height / hauteur    **Hs:** altura asiento / seat height / hauteur du siège

silla con brazos / armchair / fauteuil

# netkat

DESIGNED BY JOSEP LLUSCÀ



ASOCIADO N°01684

**AIDIMA**  
INSTITUTO TECNOLÓGICO  
MUEBLE, MADERA, EMBALAJE Y AFINES



Silla con brazos para uso interior y exterior. Inyectada en fibra de vidrio con PP mediante tecnología de moldeo asistida por gas. Apilable. Protección UV. Peso neto 4,10 Kg.

Armchair for indoor and outdoor use. Injected with fiberglass and PP using gas assisted injection moulding technology. Stackable. UV protection. Net weight 4,10 kg. (9.03 lb).

Fauteuil d'intérieur et extérieur. Injecté avec fibre de verre et PP, en utilisant technologie de moulage assistée par gaz. Empilable. Protection UV. Poids net 4,10 kg.

Netkat Armchair Test Certificates:

AIDIMA UNE EN 15373:07 General Public Use / UNE EN 1728:01

Units STD	Packaging Dimensions (cm)	m3/ pack	NW Unit (kg)	Units Container 20'	Units Container 40'	Units Container HC	Units Trayler (70m3)	Units Truck 100m3
2	66,1x60,1x90	0,357	4,10	138	304	304	436	562
4	73,7x60,7x97,5	0,41	4,10	216	456	456	528	768
23	98x58x217	1,359	4,10	552	1.104	1.104	1.242	1.334

**W** 56 x **L** 55,5 x **H** 79 x **Hs** 47 x **Ha** 65,5 cm

**W** 22.04 x **L** 21.85 x **H** 31.10 x **Hs** 18.50 x **Ha** 25.79 in



10 u.



Blanco  
White  
Blanc



Verde oliva  
Olive green  
Vert olive



Chocolate  
Chocolate  
Chocolat



Negro  
Black  
Noir



Arena  
Sand  
Sable

**W:** ancho / width / largeur **L:** largo / length / longueur **H:** altura / height / hauteur **Hs:** altura asiento / seat height / hauteur du siège







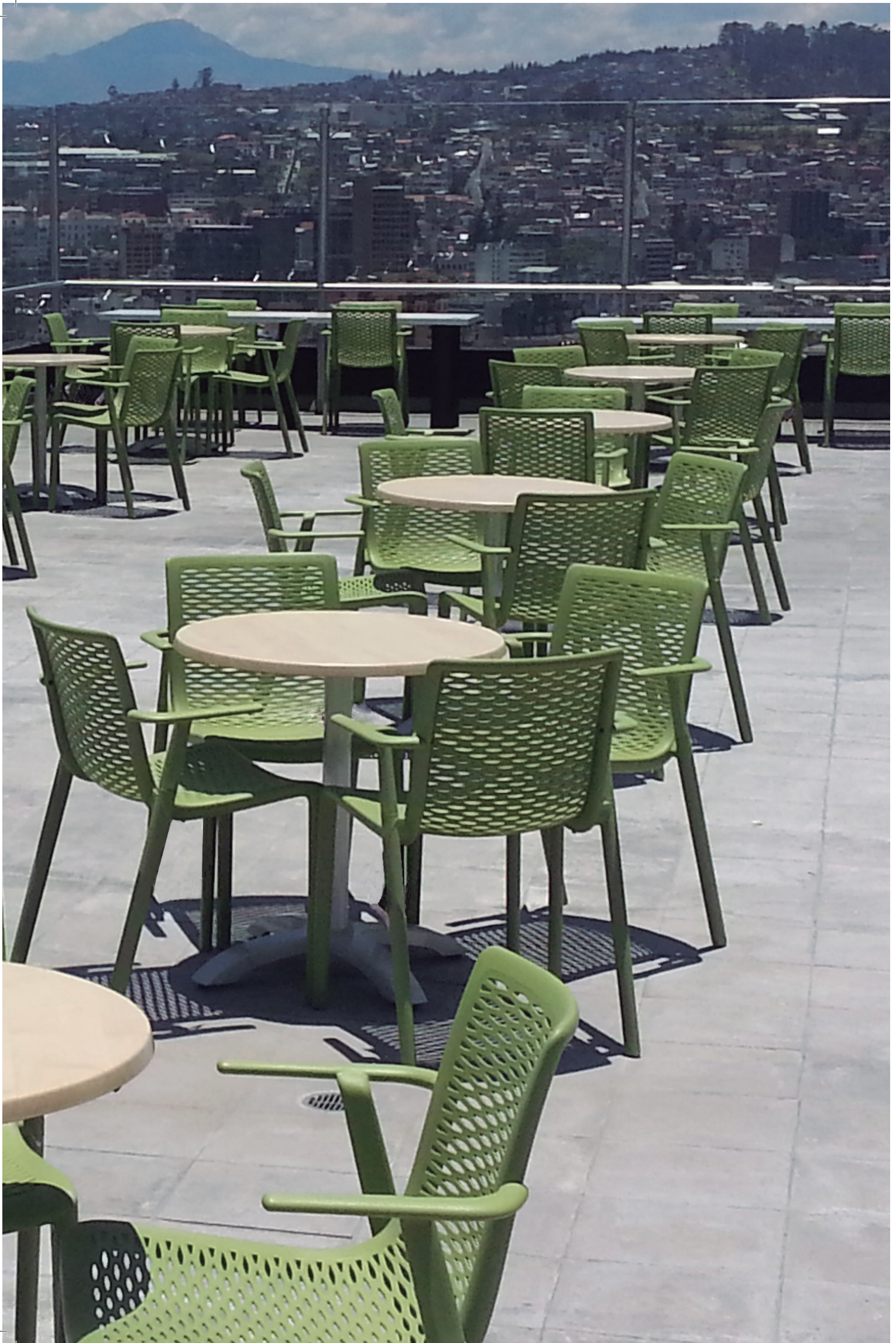



silla con brazos / armchair / fauteuil

# peach

DESIGNED BY JOAN GASPAR

Barcelona Dd



Tapizado Barcelona Dd disponible, pag. 132.  
Barcelona Dd Upholstered available, pag. 132.  
Revêtement Barcelona Dd disponible, pag. 132.

ASOCIADO N°01684  
**AIDIMA**  
INSTITUTO TECNOLÓGICO  
MUEBLE, MADERA, EMBALAJE Y AFINES



Silla con brazos para uso interior y exterior. Inyectada en fibra de vidrio con PP mediante tecnología de moldeo asistida por gas. Apilable. Protección UV. Peso neto 4,20 kg.

Armchair for indoor and outdoor use. Injected with fiberglass and PP using gas assisted injection moulding technology. Stackable. UV protection. Net weight 4,20 kg (9.26 lb).

Fauteuil d'intérieur et extérieur. Injecté avec fibre de verre et PP, en utilisant technologie de moulage assistée par gaz. Empilable. Protection UV. Poids net 4,20 kg.

Peach Test Certificates:  
AIDIMA UNE EN 15373:07 General Public Use / UNE EN 1728:01

Units STD	Packaging Dimensions (cm)	m3/ pack	NW Unit (kg)	Units Container 20'	Units Container 40'	Units Container HC	Units Trayler (70m3)	Units Truck 100m3
2	66,1x60,1x90	0,357	4,20	138	304	304	436	562
4	73,7x60,7x97,5	0,37	4,20	216	456	456	528	768
24	98x58x220	1,25	4,20	576	1.152	1.152	1.296	1.392

**W** 55,90 x **L** 48 x **H** 74,50 x **Hs** 44,40 x **Ha** 63,90 cm  
**W** 22.01 x **L** 18.90 x **H** 29.33 x **Hs** 17.48 x **Ha** 25.16 in



Blanco  
White  
Blanc



Rojo  
Red  
Rouge



Chocolate  
Chocolate  
Chocolat



Negro  
Black  
Noir



Arena  
Sand  
Sable



Verde oliva  
Olive green  
Vert olive

**W:** ancho / width / largeur **L:** largo / length / longueur **H:** altura / height / hauteur **Hs:** altura asiento / seat height / hauteur du siège **Ha:** altura brazo / armrest height / hauteur de l'accoudoir







silla / chair / chaise

# carla

DESIGNED BY FABRIZIO BATONI

Barcelona Dd



CATAS®

Silla para uso interior y exterior. Inyectada con fibra de vidrio y PP. Apilable. Protección contra rayos UV. Peso neto silla 4 kg.

Chair for indoor and outdoor use, injected with fiberglass and PP. Stackable. UV protection. Chair's net weight 4 kg. (8.82 lb).

Chaise d'intérieur et extérieur. Injectée avec fibre de verre et PP. Empilable. Protection contre les rayons UV. Poids net chaise 4 kg.

Carla Test Certificates:  
EN 15373:2007 / EN 1022:2005 / EN 1728:2000

Units STD	Packaging Dimensions (cm)	m3/ pack	NW Unit (kg)	Units Container 20'	Units Container 40'	Units Container HC	Units Trayler (70m3)	Units Truck 100m3
2	66,1x60,1x90	0,357	4	138	304	304	436	562
4	58X58X105	0,35	4	320	640	640	736	832
14	105x58x220	1,34	4	308	616	616	700	840

W 56,50 x L 55,70 x H 78,70 x Hs 45 cm  
W 22.24 x L 21.93 x H 30.98 x Hs 17.72 in



Blanco  
White  
Blanc



Rojo  
Red  
Rouge



Negro  
Black  
Noir

W: ancho / width / largeur L: largo / length / longueur H: altura / height / hauteur Hs: altura asiento / seat height / hauteur du siège







silla / chair / chaise

# lama

DESIGNED BY JOSEP LLUSCA

Barcelona Dd



ASOCIADO N°01684

**AIDIMA**  
INSTITUTO TECNOLÓGICO  
MUEBLE, MADERA, EMBALEAJE Y AFINES

Silla para uso interior y exterior. Inyectada en fibra de vidrio con PP mediante tecnología de moldeo asistida por gas. Apilable. Protección UV. Peso neto 4 kg. Opcional: Pinza enlace de sillas para convenciones y eventos inyectada en policarbonato translúcido.

Chair for indoor and outdoor use. Injected with fiberglass and PP using gas assisted injection moulding technology. Stackable. UV protection. Net weight 4 kg. (8.80 lb). Optional: Clamp connection of chairs for conventions and events injected in translucent polycarbonate.

Chaise d'intérieur et extérieur. Injectée avec fibre de verre et PP, en utilisant technologie de moulage assistée par gaz. Empilable. Protection UV. Poids net 4 kg. Optionnel: Pince de jonction des chaises pour conventions et événements injectée en polycarbonate translucide.

Lama Test Certificates:  
AIDIMA UNE EN 15373:07 General Public Use / UNE EN 1728:01

Units STD	Packaging Dimensions (cm)	m3/pack	NW Unit (kg)	Units Container 20'	Units Container 40'	Units Container HC	Units Trayler (70m3)	Units Truck 100m3
2	66,1x60,1x90	0,357	4	138	304	304	436	562
4	73,7x52x97,5	0,37	4	280	568	568	632	808
24	98x58x218	1,24	4	536	1.152	1.152	1.296	1.392

**W** 48 x **L** 54 x **H** 80 x **Hs** 47,5 cm  
**W** 18.89 x **L** 21.26 x **H** 31.50 x **Hs** 18.70 in



Blanco  
White  
Blanc



Verde oliva  
Olive green  
Vert olive



Chocolate  
Chocolate  
Chocolat



Negro  
Black  
Noir



Arena  
Sand  
Sable



Gris oscuro  
Dark gray  
Gris foncé

**W:** ancho / width / largeur **L:** largo / length / longueur **H:** altura / height / hauteur **Hs:** altura asiento / seat height / hauteur du siège

silla con brazos / armchair / fauteuil

# lama

DESIGNED BY JOSEP LLUSCÀ



Barcelona Dd

ASOCIADO N°01684  
**AIDIMA**  
 INSTITUTO TECNOLÓGICO  
 MUEBLE, MADERA, EMBAJALÉ Y AFINES

Silla con brazos para uso interior y exterior. Inyectada en fibra de vidrio con PP mediante tecnología de moldeo asistida por gas. Apilable. Protección UV. Peso neto 4,3 kg. Opcional: Pinza enlace de sillas para convenciones y eventos inyectada en policarbonato translúcido.

Armchair for indoor and outdoor use. Injected with fiberglass and PP using gas assisted injection moulding technology. Stackable. UV protection. Net weight 4,3 kg. (9.48 lb). Optional: Clamp connection of chairs for conventions and events injected in translucent polycarbonate.

Fauteuil d'intérieur et extérieur. Injecté avec fibre de verre et PP, en utilisant technologie de moulage assistée par gaz. Empilable. Protection UV. Poids net 4,3 kg. Optionnel: Pince de jonction des chaises pour conventions et événements injectée en polycarbonate translucide.

Lama Armchair Test Certificates:  
 AIDIMA UNE EN 15373:07 General Public Use / UNE EN 1728:01

Units STD	Packaging Dimensions (cm)	m3/ pack	NW Unit (kg)	Units Container 20'	Units Container 40'	Units Container HC	Units Traylor (70m3)	Units Truck 100m3
2	66,1x60,1x90	0,357	4,3	138	304	304	436	562
4	73,7x60,7x97,5	0,37	4,3	216	456	456	528	768
20	98x58x220	1,25	4,3	480	960	960	1.080	1.160

**W** 57 x **L** 54 x **H** 80 x **Hs** 47,5 x **Ha** 66 cm  
**W** 22.41 x **L** 21.26 x **H** 31.50 x **Hs** 18.70 x **Ha** 25.99 in



Blanco  
White  
Blanc



Verde oliva  
Olive green  
Vert olive



Chocolate  
Chocolate  
Chocolat



Negro  
Black  
Noir



Arena  
Sand  
Sable



Gris oscuro  
Dark gray  
Gris foncé

**W:** ancho / width / largeur **L:** largo / length / longueur **H:** altura / height / hauteur **Hs:** altura asiento / seat height / hauteur du siège

Referencias nuevas marcadas en rojo / New SKUs shown in red colour / Nouvelles références en rouge











silla / chair / chaise

# trama

DESIGNED BY JOSEP LLUSCA

Barcelona Dd



ASOCIADO N°01684

**AIDIMA**  
INSTITUTO TECNOLÓGICO  
MUEBLERÍA, MADERA, EMBALAJE Y AFINES



Silla para uso interior y exterior. Inyectada en fibra de vidrio con PP mediante tecnología de moldeo asistida por gas. Apilable. Protección UV. Peso neto 4 kg. Opcional: Pinza enlace de sillas para convenciones y eventos inyectada en policarbonato translúcido.

Chair for indoor and outdoor use. Injected with fiberglass and PP using gas assisted injection moulding technology. Stackable. UV protection. Net weight 4 kg. (8.80 lb). Optional: Clamp connection of chairs for conventions and events injected in translucent polycarbonate.

Chaise d'intérieur et extérieur. Injectée avec fibre de verre et PP, en utilisant technologie de moulage assistée par gaz. Empilable. Protection contre les rayons UV. Poids net 4 kg. Optionnel: Pince de jonction des chaises pour conventions et événements injectée en polycarbonate translucide.

Trama Test Certificates:  
AIDIMA UNE EN 15373:07 General Public Use / UNE EN 1728:01

Units STD	Packaging Dimensions (cm)	m3/ pack	NW Unit (kg)	Units Container 20'	Units Container 40'	Units Container HC	Units Trayler (70m3)	Units Truck 100m3
2	66,1x60,1x90	0,357	4	69	152	152	218	281
4	73,7x52x97,5	0,37	4	280	568	568	632	808
24	98x58x218	1,24	4	536	1.152	1.152	1.296	1.392

**W** 48 x **L** 54 x **H** 80 x **Hs** 47,50 cm  
**W** 18.90 x **L** 21.26 x **H** 31.50 x **Hs** 18.70 in



Blanco  
White  
Blanc



Verde oliva  
Olive green  
Vert olive



Chocolate  
Chocolate  
Chocolat



Negro  
Black  
Noir



Arena  
Sand  
Sable

**W:** ancho / width / largeur **L:** largo / length / longueur **H:** altura / height / hauteur **Hs:** altura asiento / seat height / hauteur du siège **Ha:** altura brazo / armrest height / hauteur de l'accoudoir

silla con brazos / armchair / fauteuil

# trama

DESIGNED BY JOSEP LLUSCÀ



ASOCIADO N°01684

**AIDIMA**  
INSTITUTO TECNOLÓGICO  
MUEBLE, MADERA, EMBALAJE Y AFINES



Silla con brazos para uso interior y exterior. Inyectada en fibra de vidrio con PP mediante tecnología de moldeo asistida por gas. Apilable. Protección UV. Peso neto 4,3 kg. Opcional: Pinza enlace de sillas para convenciones y eventos inyectada en policarbonato translúcido.

Armchair for indoor and outdoor use. Injected with fiberglass and PP using gas assisted injection moulding technology. Stackable. UV protection. Net weight 4,3 kg. (9.48 lb). Optional: Clamp connection of chairs for conventions and events injected in translucent polycarbonate.

Fauteuil d'intérieur et extérieur. Injecté avec fibre de verre et PP, en utilisant technologie de moulage assistée par gaz. Empilable. Protection UV. Poids net 4,3 kg. Optionnel: Pince de jonction des chaises pour conventions et événements injectée en polycarbonate translucide.

Trama Armchair Test Certificates:

AIDIMA UNE EN 15373:07 General Public Use / UNE EN 1728:01

Units STD	Packaging Dimensions (cm)	m3/ pack	NW Unit (kg)	Units Container 20'	Units Container 40'	Units Container HC	Units Traylor (70m3)	Units Truck 100m3
2	66,1x60,1x90	0,357	4,3	138	304	304	436	562
4	73,7x60,7x97,5	0,42	4,3	216	456	456	528	768
20	98x58x220	1,25	4,3	506	1.104	1.104	1.196	1.518

**W** 57 x **L** 54 x **H** 80 x **Hs** 47,50 x **Ha** 66 cm

**W** 22.44 x **L** 21.26 x **H** 31.50 x **Hs** 18.70 x **Ha** 25.99 in



Blanco  
White  
Blanc



Verde oliva  
Olive green  
Vert olive



Chocolate  
Chocolate  
Chocolat



Negro  
Black  
Noir



Arena  
Sand  
Sable

**W:** ancho / width / largeur **L:** largo / length / longueur **H:** altura / height / hauteur **Hs:** altura asiento / seat height / hauteur du siège **Ha:** altura brazo / armrest height / hauteur de l'accoudoir











silla / chair / chaise

# gina

DESIGNED BY JOAN GASPAR

Barcelona Dd

novedad  
new nouveauté



Silla para uso interior y exterior. Inyectada en fibra de vidrio con PP mediante tecnología de moldeo asistida por gas. Apilable. Protección UV. Peso neto 3,35 kg.

Chair for indoor and outdoor use. Injected with fiberglass and PP using gas assisted injection moulding technology. Stackable. UV protection. Net weight 3,35 kg. (7.38 lb).

Chaise d'intérieur et extérieur. Injectée avec fibre de verre et PP, en utilisant technologie de moulage assistée par gaz. Empilable. Protection UV. Poids net 3,35 kg.

Units STD	Packaging Dimensions (cm)	m3/ pack	NW Unit (kg)	Units Container 20'	Units Container 40'	Units Container HC	Units Traylor (70m3)	Units Truck 100m3
2	66,1x60,1x90	0,357	3,35	138	304	304	436	562
4	73,7x60,7x96,9	0,433	3,35	176	400	-	528	-
32	98x58x220	1,25	3,35	720	1440	1440	1560	-

**W** 52,3 x **L** 52 x **H** 80,5 x **Hs** 46,1 cm  
**W** 20.60 x **L** 20.48 x **H** 31.70 x **Hs** 18.15 in



10 u.



Blanco  
White  
Blanc



Rojo  
Red  
Rouge



Verde oliva  
Olive green  
Vert olive



Chocolate  
Chocolate  
Chocolat



Arena  
Sand  
Sable

**W:** ancho / width / largeur **L:** largo / length / longueur **H:** altura / height / hauteur **Hs:** altura asiento / seat height / hauteur du siège

silla con brazos / armchair / fauteuil

# gina

DESIGNED BY JOAN GASPAR

novedad  
new nouveauté



Barcelona Dd

Silla con brazos para uso interior y exterior. Inyectada en fibra de vidrio con PP mediante tecnología de moldeo asistida por gas. Apilable. Protección UV. Peso neto 3,65 kg. Tornillos inoxidables.

Armchair for indoor and outdoor use. Injected with fiberglass and PP using gas assisted injection moulding technology. Stackable. UV protection. Net weight 3,65 kg. (8.04 lb). Stainless steel screws.

Fauteuil d'intérieur et extérieur. Injecté avec fibre de verre et PP, en utilisant technologie de moulage assistée par gaz. Empilable. Protection UV. Poids net 3,65 kg. Vis en acier inoxydable.

Units STD	Packaging Dimensions (cm)	m3/ pack	NW Unit (kg)	Units Container 20'	Units Container 40'	Units Container HC	Units Traylor (70m3)	Units Truck 100m3
2	66,1x60,1x90	0,357	3,65	138	304	304	436	562
4	73,7x60,7x96,9	0,433	3,65	176	400	-	528	768

**W** 56,9 x **L** 52 x **H** 80.5 x **Hs** 46,1 cm

**W** 22.40 x **L** 20.48 x **H** 31.70 x **Hs** 31.70 x **Ha** 18.15 in



7 u.



Blanco  
White  
Blanc



Rojo  
Red  
Rouge



Verde oliva  
Olive green  
Vert olive



Chocolate  
Chocolate  
Chocolat



Arena  
Sand  
Sable

**W:** ancho / width / largeur **L:** largo / length / longueur **H:** altura / height / hauteur **Hs:** altura asiento / seat height / hauteur du siège **Ha:** altura brazo / armrest height / hauteur de l'accoudoir







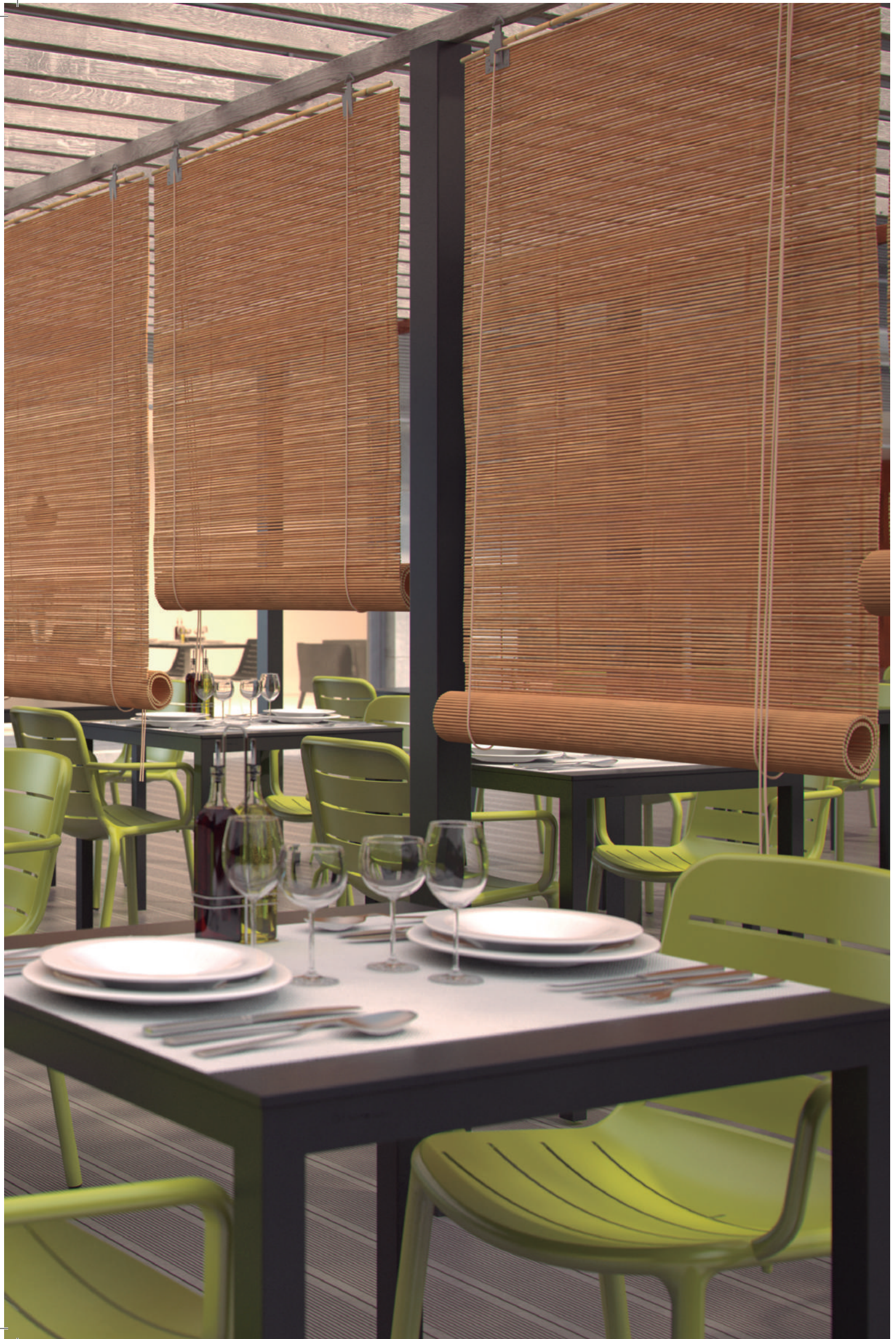



silla / chair / chaise

# lisboa

DESIGNED BY JOAN GASPAR

Barcelona Dd



Tapizado Barcelona Dd disponible, pag. 133.  
 Barcelona Dd Upholstered available, pag. 133.  
 Revêtement Barcelona Dd disponible, pag. 133.

ASOCIADO N°01684

**AIDIMA**  
 INSTITUTO TECNOLÓGICO  
 MUEBLE, MADERA, EMBALAJE Y AFINES

**FIRA**  
 TESTING-CERTIFICATION

Silla para uso interior y exterior. Inyectada en fibra de vidrio con PP mediante tecnología de moldeo asistida por gas. Apilable. Protección UV. Peso neto 3,36 kg.

Chair for indoor and outdoor use. Injected with fiberglass and PP using gas assisted injection moulding technology. Stackable. UV protection. Net weight 3,36 kg. (7.39 lb).

Chaise d'intérieur et extérieur. Injectée avec fibre de verre et PP, en utilisant technologie de moulage assistée par gaz. Empilable. Protection UV. Poids net 3,36 kg.

Lisboa Test Certificates:

AIDIMA UNE EN 15373:07 General Public Use / UNE EN 1728:01  
 FIRA BS EN 15373:2007 Test Level 2 / BS EN 1022:2005

Units STD	Packaging Dimensions (cm)	m3/ pack	NW Unit (kg)	Units Container 20'	Units Container 40'	Units Container HC	Units Traylor (70m3)	Units Truck 100m3
2	66,1x60,1x90	0,357	3,36	138	304	304	436	562
4	62,4x61x104	0,37	3,36	216	456	456	528	768
24	98x58x220	1,25	3,36	576	1.152	1.152	1.296	1.392

**W** 48 x **L** 52 x **H** 82 x **Hs** 49 cm  
**W** 18.90 x **L** 20.48 x **H** 32.29 x **Hs** 19.29 in



Blanco  
 White  
 Blanc



Rojo  
 Red  
 Rouge



Verde oliva  
 Olive green  
 Vert olive



Chocolate  
 Chocolate  
 Chocolat



Negro  
 Black  
 Noir



Arena  
 Sand  
 Sable



Toscano  
 Tuscan  
 Toscan



Gris oscuro  
 Dark grey  
 Gris foncé

**W:** ancho / width / largeur **L:** largo / length / longueur **H:** altura / height / hauteur **Hs:** altura asiento / seat height / hauteur du siège

60 Referencias nuevas marcadas en rojo / New SKUs shown in red colour / Nouvelles références en rouge







silla con brazos / armchair / fauteuil

# lisboa

DESIGNED BY JOAN GASPAR

Barcelona Dd



Tapizado Barcelona Dd disponible, pag. 133.

Barcelona Dd Upholstered available, pag. 133.

Revêtement Barcelona Dd disponible, pag. 133.

ASOCIADO N°01684

**AIDIMA**  
INSTITUTO TECNOLÓGICO  
MUEBLE, MADERA, EMBALAJE Y AFINES

**FIRA**  
TESTING+CERTIFICATION

Silla con brazos para uso interior y exterior. Inyectada en fibra de vidrio con PP mediante tecnología de moldeo asistida por gas. Apilable. Protección UV. Peso neto 3,67 kg. Tornillos inoxidables.

Armchair for indoor and outdoor use. Injected with fiberglass and PP using gas assisted injection moulding technology. Stackable. UV protection. Net weight 3,67 kg. (8.07 lb). Stainless steel screws.

Fauteuil d'intérieur et extérieur. Injecté avec fibre de verre et PP, en utilisant technologie de moulage assistée par gaz. Empilable. Protection UV. Poids net 3,67 kg. Vis en acier inoxydable.

Lisboa Armchair Test Certificates:

AIDIMA UNE EN 15373:07 General Public Use / UNE EN 1728:01  
FIRA BS EN 15373:2007 Test Level 2 / BS EN 1022:2005

Units STD	Packaging Dimensions (cm)	m3/ pack	NW Unit (kg)	Units Container 20'	Units Container 40'	Units Container HC	Units Traylor (70m3)	Units Truck 100m3
2	66,1x60,1x90	0,357	3,67	138	304	304	436	562
4	62,4x61x104	0,37	3,67	216	456	456	528	768
23	98x58x220	1,25	3,67	552	1.104	1.104	1.242	1.334

**W** 60 x **L** 52 x **H** 82 x **Hs** 49 x **Ha** 71 cm

**W** 22.62 x **L** 20.48 x **H** 32.29 x **Hs** 19.29 x **Ha** 27.95 in



7 u.



Blanco  
White  
Blanc



Rojo  
Red  
Rouge



Verde oliva  
Olive green  
Vert olive



Chocolate  
Chocolate  
Chocolat



Negro  
Black  
Noir



Arena  
Sand  
Sable



Gris oscuro  
Dark grey  
Gris foncé

**W:** ancho / width / largeur **L:** largo / length / longueur **H:** altura / height / hauteur **Hs:** altura asiento / seat height / hauteur du siège **Ha:** altura brazo / armrest height / hauteur de l'accoudoir

62 Referencias nuevas marcadas en rojo / New SKUs shown in red colour / Nouvelles références en rouge

silla ignífuga / fire retardant chair / chaise ignifuge

# lisboa ignífuga

DESIGNED BY JOAN GASPAR



Barcelona Dd

Silla y silla con brazos para uso interior y exterior. Inyectada en fibra de vidrio con PP aditivado para comportamiento ignífugo mediante tecnología de moldeo asistida por gas. Protección UV. Peso neto silla 3,36 kg. Peso neto silla con brazos 3,67 kg.

Chair and armchair for indoor and outdoor use. Injected with fiberglass and PP with additives for fire retardant performances using gas assisted injection moulding technology. UV protection. Net weight chair 3,36 kg. (7.39 lb). Net weight armchair 3,67 kg (8.07 lb).

Chaise et fauteuil d'intérieur et extérieur. Injectés avec fibre de verre et PP avec additifs pour comportement ignifuge en utilisant technologie de moulage assistée par gaz. Protection UV. Poids net chaise 3,36 kg. Poids net fauteuil 3,67 kg.



Blanco  
White  
Blanc



Chocolate  
Chocolate  
Chocolat

Cualquier otro color bajo pedido y plazo de entrega. Consultar Departamento Comercial.

Any other colour upon request, delivery time varies. Ask the Sales Department.

N'importe quelle couleur sur commande et délai de livraison. Consulter le Département Commercial.

Units STD	Packaging Dimensions (cm)	m3/ pack	NW Unit (kg)	Units Container 20'	Units Container 40'	Units Container HC	Units Traylor (70m3)	Units Truck 100m3
4	62,4x61x104	0,37	3,36	216	456	456	528	768
24	98x58x220	1,25	3,36	576	1.152	1.152	1.296	1.392

Units STD	Packaging Dimensions (cm)	m3/ pack	NW Unit (kg)	Units Container 20'	Units Container 40'	Units Container HC	Units Traylor (70m3)	Units Truck 100m3
4	62,4x61x104	0,37	3,67	216	456	456	528	768
23	98x58x220	1,25	3,67	552	1.104	1.104	1.242	1.334



10 u.

**W** 48 x **L** 52 x **H** 82 x **Hs** 49 cm

**W** 18.90 x **L** 20.48 x **H** 32.29 x **Hs** 19.29 in



7 u.

**W** 60 x **L** 52 x **H** 82 x **Hs** 49 x **Ha** 71 cm

**W** 22.62 x **L** 20.48 x **H** 32.29 x **Hs** 19.29 x **Ha** 27.95 in

**W:** ancho / width / largeur **L:** largo / length / longueur **H:** altura / height / hauteur **Hs:** altura asiento / seat height / hauteur du siège **Ha:** altura brazo / armrest height / hauteur de l'accoudoir



silla / chair / chaise

# spot

DESIGNED BY JOSEP LLUSCA

Barcelona Dd

Diseño compacto ideal para espacios reducidos  
 Compact design ideal for small spaces  
 Design compact idéal pour espaces réduits



ASOCIADO N°01684  
**AIDIMA**  
 INSTITUTO TECNOLÓGICO  
 MUEBLE, MADERA, EMBALAJE Y AFINES

Silla para uso interior y exterior. Inyectada en fibra de vidrio con PP mediante tecnología de moldeo asistida por gas. Apilable. Protección contra rayos UV. Peso neto 2,80 kg.

Chair for indoor and outdoor use. Injected in fiberglass with PP using gas assisted injection moulding technology. Stackable. UV Protection. Net weight 2,80 kg (6.16 lb).

Chaise d'intérieur et extérieur. Injectée avec fibre de verre et PP, en utilisant technologie de moulage assistée par gaz. Empilable. Protection UV. Poids net 2,80 kg.

Spot Test Certificates:  
 AIDIMA UNE EN 581-1:2006 Public  
 AIDIMA UNE EN 581-2:2009 Public

Units STD	Packaging Dimensions (cm)	m3/ pack	NW Unit (kg)	Units Container 20'	Units Container 40'	Units Container HC	Units Traylor (70m3)	Units Truck 100m3
2	66,1x60,1x90	0,357	2,80	138	304	304	436	562
4	73,7x52x97,5	0,37	2,80	280	568	568	632	808
22	90x58x218	1,239	2,80	528	1056	1056	1188	1276

**W** 45 x **L** 54 x **H** 78 **Hs** 45 cm  
**W** 17.71 x **L** 21.26 x **H** 30.71 **Hs** 17.72 in



Blanco  
White  
Blanc



Rojo  
Red  
Rouge



Verde oliva  
Olive green  
Vert olive



Chocolate  
Chocolate  
Chocolat



Negro  
Black  
Noir



Arena  
Sand  
Sable



Toscano  
Tuscan  
Toscan

**W:** ancho / width / largeur **L:** largo / length / longueur **H:** altura / height / hauteur **Hs:** altura asiento / seat height / hauteur du siège





silla / chair / chaise

# neutra

DESIGNED BY JOAN GASPAR

Barcelona Dd

Diseño compacto ideal para espacios reducidos  
 Compact design ideal for small spaces  
 Design compact idéal pour espaces réduits

Tapizado Barcelona Dd disponible, pag. 133.

Barcelona Dd Upholstered available, pag. 133.

Revêtement Barcelona Dd disponible, pag. 133.

ASOCIADO N°01684

**AIDIMA**  
 INSTITUTO TECNOLÓGICO  
 MUEBLE, MADERA, EMBALAJE Y AFINES



Silla para uso interior y exterior. Inyectada en fibra de vidrio con PP mediante tecnología de moldeo asistida por gas. Apilable. Protección UV. Peso neto 3,20 kg.

Chair for indoor and outdoor use. Injected with fiberglass and PP using gas assisted injection moulding technology. Stackable. UV protection. Net weight 3,20 kg (7.05 lb).

Chaise d'intérieur et extérieur. Injectée avec fibre de verre et PP, en utilisant technologie de moulage assistée par gaz. Empilable. Protection UV. Poids net 3,20 kg.

Neutra Test Certificates:

AIDIMA UNE EN 15373:07 General Public Use / UNE EN 1728:01

Units STD	Packaging Dimensions (cm)	m3/ pack	NW Unit (kg)	Units Container 20'	Units Container 40'	Units Container HC	Units Trayler (70m3)	Units Truck 100m3
2	66,1x60,1x90	0,357	3,20	138	304	304	436	562
4	73,7x52x97,5	0,37	3,20	280	568	568	632	808
29	98x58x218	1,239	3,20	696	1.392	1.392	1.566	1.682

**W** 47 x **L** 48 x **H** 78 **Hs** 46 cm  
**W** 18.50 x **L** 18.89 x **H** 30.71 **Hs** 18.11 in



Blanco  
White  
Blanc



Rojo  
Red  
Rouge



Verde oliva  
Olive green  
Vert olive



Chocolate  
Chocolate  
Chocolat



Negro  
Black  
Noir



Arena  
Sand  
Sable

**W:** ancho / width / largeur **L:** largo / length / longueur **H:** altura / height / hauteur **Hs:** altura asiento / seat height / hauteur du siège





silla / chair / chaise

# julia

DESIGNED BY JOAN GASPAR

Barcelona Dd



ASOCIADO N°01684

**AIDIMA**  
INSTITUTO TECNOLÓGICO  
MUEBLE, MADERA, EMBALAJE Y AFINES

Silla para uso interior y exterior. Inyectada en polipropileno. Apilable. Protección UV. Peso neto 3,35 kg.

Chair for indoor and outdoor use. Injected with polypropylene. Stackable. UV protection. Net weight 3,35 kg (7.39 lb).

Chaise d'intérieur et extérieur. Injectée en polypropylène. Empilable. Protection UV. Poids net 3,35 kg.

Julia Test Certificates:

FIRA BS EN 581-1:2006 / DD ENV 581-2: 2000 Contract Level/ BS EN 1022:2005  
AIDIMA UNE EN 15373:07 General Public Use / UNE EN 1728:01

Units STD	Packaging Dimensions (cm)	m3/ pack	NW Unit (kg)	Units Container 20'	Units Container 40'	Units Container HC	Units Trayler (70m3)	Units Truck 100m3
4	60x60x220	0,79	3,35	540	1.200	1.200	1.760	2.000
23	60x60x240	0,86	3,35	-	-	-	2.024	2.300



20 u.

**W** 54 x **L** 56 x **H** 82 x **Hs** 44 cm

**W** 21.26 x **L** 22.05 x **H** 32.29 x **Hs** 17.32 in



Negro  
Black  
Noir



Chocolate  
Chocolate  
Chocolat



Blanco  
White  
Blanc



Rojo  
Red  
Rouge



Verde lima  
Lime green  
Vert lime



Naranja  
Orange  
Orange

**W:** ancho / width / largeur **L:** largo / length / longueur **H:** altura / height / hauteur **Hs:** altura asiento / seat height / hauteur du siège





sillón / armchair / fauteuil

# pole deluxe

DESIGNED BY JOSEP LLUSCÀ

Barcelona Dd

ASOCIADO N°01684

**AIDIMA**  
INSTITUTO TECNOLÓGICO  
MUEBLE, MADERA, EMBALAJE Y AFINES

**FIRA**  
TESTING+CERTIFICATION

**GROUPE ESSAIS  
POURQUERY**



Silla con brazos para uso interior y exterior. Asiento inyectado en polipropileno. Patas de aluminio anodizado de alta resistencia pintadas por pulverización al horno. Apilable. Sistema de evacuación de agua. Protección contra rayos UV. Peso neto 3,85 kg.

Armchair for indoor and outdoor use. Seat injected with polypropylene. High-resistance anodized aluminium powder-coated legs. Stackable. Water drainage system. UV protection. Net weight 3,85 kg. (8,47 lb).

Fauteuil d'intérieur et extérieur. Siège et dossier injectés en polypropylène. Pieds en aluminium anodisé d'haute résistance peints par pulvérisation au four. Empilable. Système d'évacuation d'eau. Protection contre les rayons UV. Poids net 3,85 kg.

Pole Test Certificates:

AIDIMA UNE EN 15373:07 General Public Use / UNE EN 1728:01  
FIRA BS EN 581-1:2006 / DD ENV 581-2: 2000 Contract Level / BS EN 1022:2005  
POURQUERY EN 581-1: 1997 / EN 1022:1997 / ENV 581-2: 2000

Units STD	Packaging Dimensions (cm)	m3/ pack	NW Unit (kg)	Units Container 20'	Units Container 40'	Units Container HC	Units Traylor (70m3)	Units Truck 100m3
2	66,1x60,1x90	0,357	3,85	138	304	304	436	562
4	83,5x60x95	0,47	3,85	216	372	540	576	800
16	98x58x218	1,24	3,85	384	768	768	864	928



**W** 60 x **L** 60 x **H** 78,5 x **Hs** 46 x **Ha** 67 cm

**W** 23.62 x **L** 23.62 x **H** 30.91 x **Hs** 18.11 x **Ha** 26.38 in



Blanco  
White  
Blanc



Negro  
Black  
Noir

**W:** ancho / width / largeur **L:** largo / length / longueur **H:** altura / height / hauteur **Hs:** altura asiento / seat height / hauteur du siège **Ha:** altura brazo / armrest height / hauteur de l'accoudoir

sillón / armchair / fauteuil

# pole

DESIGNED BY JOSEP LLUSCÀ



ASOCIADO N°01684

**AIDIMA**  
INSTITUTO TECNOLÓGICO  
MUEBLE, MADERA, EMBALEAJE Y AFINES

**FIRA**  
TESTING • CERTIFICATION

Silla con brazos para uso interior y exterior. Asiento inyectado en polipropileno. Patas de aluminio anodizado de alta resistencia. Apilable. Sistema de evacuación de agua. Protección contra rayos UV. Peso neto 3,85 kg.

Armchair for indoor and outdoor use. Seat injected with polypropylene. High-resistance anodized aluminium legs. Stackable. Water drainage system. UV protection. Net weight 3,85 kg. (8,48 lb).

Fauteuil d'intérieur et extérieur. Siège et dossier injectés en polypropylène. Pieds en aluminium anodisé d'haute résistance. Empilable. Système d'évacuation d'eau. Protection contre les rayons UV. Poids net 3,85 kg.

Pole Test Certificates:

AIDIMA UNE EN 15373:07 General Public Use / UNE EN 1728:01

FIRA BS EN 581-1:2006 / DD ENV 581-2: 2000 Contract Level/ BS EN 1022:2005

Units STD	Packaging Dimensions (cm)	m3/ pack	NW Unit (kg)	Units Container 20'	Units Container 40'	Units Container HC	Units Trayler (70m3)	Units Truck 100m3
2	66,1x60,1x90	0,357	3,85	138	304	304	436	562
4	83,5x60x95	0,47	3,85	216	372	540	576	800
16	98x58x218	1,24	3,85	384	768	768	864	928



7 u.

**W** 60 x **L** 60 x **H** 78,5 x **Hs** 46 x **Ha** 67 cm

**W** 23.62 x **L** 23.62 x **H** 30.91 x **Hs** 18.11 x **Ha** 26.38 in



Negro  
Black  
Noir



Chocolate  
Chocolate  
Chocolat



Arena  
Sand  
Sable



Verde oliva  
Olive green  
Vert olive



Blanco  
White  
Blanc



Rojo  
Red  
Rouge



Verde lima  
Lime green  
Vert lime



Naranja  
Orange  
Orange

**W:** ancho / width / largeur **L:** largo / length / longueur **H:** altura / height / hauteur **Hs:** altura asiento / seat height / hauteur du siège **Ha:** altura brazo / armrest height / hauteur de l'accoudoir











silla / chair / chaise

# moon

DESIGNED BY JOSEP LLUSCÀ

novedad  
new nouveauté

Barcelona Dd



ASOCIADO N°01684

**AIDIMA**  
INSTITUTO TECNOLÓGICO  
MUEBLE, MADERA, EMBALAJE Y AFINES

**FIRA**  
TESTING+CERTIFICATION

Silla para uso interior y exterior. Asiento inyectado en polipropileno. Patas de aluminio anodizado de alta resistencia. Apilable. Sistema de evacuación de agua. Protección contra rayos UV. Peso neto 3,40 kg.

Chair for indoor and outdoor use. Seat injected with polypropylene. High-resistance anodized aluminium legs. Stackable. Water drainage system. UV protection. Net weight 3,40 kg. (7.48 lb).

Chaise d'intérieur et extérieur. Siège et dossier injectés en polypropylène. Pieds en aluminium anodisé d'haute résistance. Empilable. Système d'évacuation d'eau. Protection contre les rayons UV. Poids net 3,40 kg.

Hey Test Certificates:

AIDIMA UNE EN 15373:07 General Public Use / UNE EN 1728:01  
Seat static loading test according to UNE-ENV 581-2 test

Units STD	Packaging Dimensions (cm)	m3/ pack	NW Unit (kg)	Units Container 20'	Units Container 40'	Units Container HC	Units Traylor (70m3)	Units Truck 100m3
2	66,1x60,1x90	0,357	3,40	138	304	304	436	562
4	73,7x52x97,5	0,37	3,40	280	568	568	632	808
20	98x58x218	1,239	3,40	480	960	960	1.080	1.160



**W** 50 x **L** 58,5 x **H** 80,5 x **Hs** 44 cm

**W** 19.68 x **L** 23.03 x **H** 31.69 x **Hs** 17.32 in



Negro  
Black  
Noir



Chocolate  
Chocolate  
Chocolat



Arena  
Sand  
Sable



Verde oliva  
Olive green  
Vert olive



Blanco  
White  
Blanc



Rojo  
Red  
Rouge



Verde lima  
Lime green  
Vert lime



Naranja  
Orange  
Orange

**W:** ancho / width / largeur **L:** largo / length / longueur **H:** altura / height / hauteur **Hs:** altura asiento / seat height / hauteur du siège

sillón / armchair / fauteuil

novedad  
new nouveauté

# SUN

DESIGNED BY JOSEP LLUSCA



Barcelona Dd

ASOCIADO N°01684  
**AIDIMA**  
INSTITUTO TECNOLÓGICO  
MUEBLE, MADERA, EMBALAJE Y AFINES

Silla con brazos para uso interior y exterior. Asiento inyectado en polipropileno. Patas de aluminio anodizado de alta resistencia. Apilable. Sistema de evacuación de agua. Protección contra rayos UV. Peso neto 4,50 kg.

Armchair for indoor and outdoor use. Seat injected with polypropylene. High-resistance anodized aluminium legs. Stackable. Water drainage system. UV protection. Net weight 4,50 kg. (9.90 lb).

Fauteuil d'intérieur et extérieur. Siège et dossier injectés en polypropylène. Pieds en aluminium anodisé d'haute résistance. Empilable. Système d'évacuation d'eau. Protection contre les rayons UV. Poids net 4,50 kg.

Oh Test Certificates:

AIDIMA UNE EN 15373:07 General Public Use / UNE EN 1728:01  
Seat static loading test according to UNE-ENV 581-2 test

Units STD	Packaging Dimensions (cm)	m3/ pack	NW Unit (kg)	Units Container 20'	Units Container 40'	Units Container HC	Units Trayler (70m3)	Units Truck 100m3
2	66,1x60,1x90	0,357	4,50	138	304	304	436	562
4	73,7x60,7x97,5	0,39	4,50	216	456	456	528	768
20	98x60x218	1,281	4,50	400	840	840	960	1.040



10 u.

**W** 60 x **L** 58 x **H** 76 x **Hs** 46 x **Ha** 63 cm

**W** 23.62 x **L** 22.83 x **H** 29.92 x **Hs** 18.11 x **Ha** 24.80 in



Negro  
Black  
Noir



Chocolate  
Chocolate  
Chocolat



Arena  
Sand  
Sable



Verde oliva  
Olive green  
Vert olive



Blanco  
White  
Blanc



Rojo  
Red  
Rouge



Verde lima  
Lime green  
Vert lime



Naranja  
Orange  
Orange

**W:** ancho / width / largeur **L:** largo / length / longueur **H:** altura / height / hauteur **Hs:** altura asiento / seat height / hauteur du siège







g e l a t e r i





Barcelona **Dd**

mesa rectangular / rectangular table / table rectangulaire

# barcino

DESIGNED BY JOAN GASPAR



Personalización de colores disponible bajo pedido y sujetos a cantidades mínimas. Consulte el Departamento Comercial.

Colour customization is available upon request. Minimum orders are applicable. Contact the Sales Department.

Personnalisation de couleurs disponible sur commande. Quantités minimales à appliquer. Consultez le département commercialele Département Commerciale.

Mesa rectangular 180x90 para uso interior y exterior. Estructura de aluminio anodizado pintado por pulverización al horno, de 40 x 40 mm y 2 mm de grosor. Sobre de 3 mm de grosor. Peso neto 24 kg.

Rectangular table 180x90 for indoor and outdoor use. Powder coated anodized aluminium frame, 40 x 40 mm and 2 mm thick. Table top of 3 mm thickness. Net weight 24 kg (52.91 lb).

Table rectangulaire pour usage intérieur et extérieur. Structure en aluminium anodisé peinte par pulvérisation au four, de 40 x 40 mm et 2 mm de grosueur. Plateau en 3 mm de grosueur. Poids net 24 kg.

Units STD	Packaging Dimensions (cm)	m3/ pack	NW Unit (kg)	Units Container 20'	Units Container 40'	Units Container HC	Units Traylor (70m3)	Units Truck 100m3
1	186x96x16	0,286	24	130	264	264	-	-

**W** 180 x **L** 90 x **H** 73,4 cm

**W** 70.87 x **L** 35.43 x **H** 28.90 in



Negro  
Black  
Noir



Arena  
Sand  
Sable



Blanco  
White  
Blanc

**W**: ancho / width / largeur   **L**: largo / length / longueur   **H**: altura / height / hauteur

mesa apilable / stackable table / table empilable

novedad  
new nouveauté

# barcino compact

DESIGNED BY JOAN GASPAR



ASOCIADO N°01684

**AIDIMA**  
INSTITUTO TECNOLÓGICO  
MUEBLE, MADERA, EMBALAJE Y AFINES

Mesa apilable para uso interior y exterior. Estructura de aluminio anodizado pintado por pulverización y secado al horno de 40 x 40 mm y 1,5 mm de grosor. Tablero de compacto fenólico de 10 mm de grosor. Peso neto 10,68 kg.

Stackable table for indoor and outdoor use. Powder coated anodized aluminium frame and oven-drying 40 x 40 mm and 1,5 mm thick. Table top of HPL of 10 mm thickness. Net weight (10,68 kg) 23.55 lb.

Table empilable pour usage intérieur et extérieur. Structure en aluminium anodisé peinte par pulvérisation et séchée au four 40 x 40 mm et 1,5 mm de grosseur. Plateau en résine phénolique de 10 mm de grosseur. Poids net 10,68 kg.

Barcino Test Certificates:

AIDIMA UNE EN 15373:07 General Public Use / UNE EN 1728:01

Units STD	Packaging Dimensions (cm)	m3/ pack	NW Unit (kg)	Units Container 20'	Units Container 40'	Units Container HC	Units Trayler (70m3)	Units Truck 100m3
18	100x100x220	2,2	10,68	-	-	-	-	-

**W** 70 x **L** 70 x **H** 74 cm  
**W** 27.55 x **L** 27.55 x **H** 29.13 in



10 u.



Negro  
Black  
Noir



Blanco  
White  
Blanc

**W:** ancho / width / largeur **L:** largo / length / longueur **H:** altura / height / hauteur



Barcelona Dd

mesa apilable / stackable table / table empilable

# barcino

DESIGNED BY JOAN GASPAR



Personalización de colores disponible bajo pedido y sujetos a cantidades mínimas. Consulte el Departamento Comercial.

Colour customization is available upon request. Minimum orders are applicable. Contact the Sales Department.

Personnalisation de couleurs disponible sur commande. Quantités minimales à appliquer. Consultez le département commercialelele Département Commercial.

ASOCIADO N°01684  
**AIDIMA**  
INSTITUTO TECNOLÓGICO  
MUEBLE, MADERA, EMBALAJE Y AFINES

Mesa apilable para uso interior y exterior. Estructura de aluminio anodizado pintado por pulverización y secado al horno de 40 x 40 mm y 1,5 mm de grosor. Sobre de 3 mm de grosor. Peso neto mesa 70x70, 8 kg. Peso neto mesa 90x90, 11 kg.

Stackable table for indoor and outdoor use. Powder coated anodized aluminium frame and oven-drying 40 x 40 mm and 1,5 mm thick. Table top of 3 mm thickness. 70 x 70 table net weight 8 kg (17.64 lb). 90 x 90 table net weight 11 kg (24,26 lb).

Table empilable pour usage intérieur et extérieur. Structure en aluminium anodisé peinte par pulvérisation et séchée au four 40 x 40 mm et 1,5 mm de grosseur. Plateau de 3 mm de grosseur. Poids net table 70 x 70 8 kg. Poids net table 90 x 90 11 kg.

Barcino Test Certificates:

AIDIMA UNE EN 15373:07 General Public Use / UNE EN 1728:01

Units STD	Packaging Dimensions (cm)	m3/ pack	NW Unit (kg)	Units Container 20'	Units Container 40'	Units Container HC	Units Traylor (70m3)	Units Truck 100m3
18	100x100x220	2,2	8	-	-	-	-	-
18	120x120x220	3,17	11	-	-	-	-	-

W 70 x L 70 x H 74 cm

W 27.55 x L 27.55 x H 29.13 in

W 90 x L 90 x H 74 cm

W 35.43 x L 35.43 x H 29.13 in



10 u.



Negro  
Black  
Noir



Arena  
Sand  
Sable



Blanco  
White  
Blanc

W: ancho / width / largeur L: largo / length / longueur H: altura / height / hauteur





mesa pie central / pedestal base table / table pied central

# barcino

DESIGNED BY JOAN GASPAR

Barcelona Dd

Personalización de colores disponible bajo pedido y sujetos a cantidades mínimas. Consulte el Departamento Comercial.

Colour customization is available upon request. Minimum orders are applicable. Contact the Sales Department.

Personnalisation de couleurs disponible sur commande. Quantités minimales à appliquer. Consultez le département commerciale Département Commerciale.



ASOCIADO N° 01684

**AIDIMA**  
INSTITUTO TECNOLÓGICO  
MUEBLE, MADERA, EMBALAJE Y AFINES

Mesa para uso interior y exterior. Estructura de aluminio anodizado pintado por pulverización y secado al horno 40 x 20 mm y 1,5 mm de grosor. Sobre de 4 mm de grosor. Barcino 80 x 80, base de 40 x 40 cm y tubo de 8 x 8 cm. Peso neto mesa 80 x 80, 26 kg. Barcino 90 x 90, base de 45 x 45 cm y tubo de 8 x 8 cm. Peso neto mesa 90x90, 33 kg.

Table for indoor and outdoor use. Powder coated anodized aluminium frame and oven-drying 40 x 20 mm and 1,5 mm thick. Table top of 4 mm thickness. Barcino 80 x 80, base of 40x40 cm and tube of 8 x 8 cm. 80x80 table net weight 26 kg (57,32 lb). Barcino 90 x 90, base of 45 x 45 cm and tube of 8 x 8 cm. 90x90 table net weight 33 kg (72,75 lb).

Table pour usage intérieur et extérieur. Structure en aluminium anodisé peinte par pulvérisation et séchée au four 40 x 20 mm et 1,5 mm de grosseur. Plateau de 4 mm de grosseur. Barcino 80 x 80, base de 40 x 40 cm et tube de 8 x 8 cm. Poids net table 80x80, 26 kg. Barcino 90 x 90, base de 45 x 45 cm et tube de 8 x 8 cm. Poids net table 90x90, 33 kg.

Barcino Test Certificates:

AIDIMA UNE EN 15373:07 General Public Use / UNE EN 1728:01

Units STD	Packaging Dimensions (cm)	m3/ pack	NW Unit (kg)	Units Container 20'	Units Container 40'	Units Container HC	Units Traylor (70m3)	Units Truck 100m3
1	82x82x15	0,10	26	-	-	-	-	-
20	100x120x220	2,64	26	200	440	440	-	-
1	92x92x15	0,13	33	-	-	-	-	-
20	100x120x220	2,64	33	200	440	440	-	-

**W** 80 x **L** 80 x **H** 74 cm

**W** 31.50 x **L** 31.50 x **H** 29.13 in

**W** 90 x **L** 90 x **H** 74 cm

**W** 35.43 x **L** 35.43 x **H** 29.13 in



Negro  
Black  
Noir



Arena  
Sand  
Sable



Blanco  
White  
Blanc

**W:** ancho / width / largeur **L:** largo / length / longueur **H:** altura / height / hauteur

mesa pie central redonda / round pedestal base table / table ronde pied central

# barcino

DESIGNED BY JOAN GASPAR

Personalización de colores disponible bajo pedido y sujetos a cantidades mínimas. Consulte el Departamento Comercial.

Colour customization is available upon request. Minimum orders are applicable. Contact the Sales Department.

Personnalisation de couleurs disponible sur commande. Quantités minimales à appliquer. Consultez le département commerciale Département Commerciale.



ASOCIADO N°01684

**AIDIMA**  
INSTITUTO TECNOLÓGICO  
MUEBLE, MADERA, EMBALAJE Y AFINES

Mesa para uso interior y exterior. Estructura de aluminio anodizado pintado por pulverización y secado al horno 40 x 40 mm y 1,5 mm de grosor. Sobre de 4 mm de grosor. Barcino Ø 60 cm con base de Ø 35 cm y tubo de Ø 6 cm. Peso neto mesa Ø 60, 13 kg. Barcino Ø 80 cm con base de Ø 45 cm y tubo de Ø 8 cm. Peso neto mesa Ø 80, 22 kg.

Table for indoor and outdoor use. Powder coated anodized aluminium frame and oven-drying 40 x 40 mm and 1,5 mm thick. Table top of 4 mm thickness. Barcino Ø 60 cm with base of Ø 35 cm and tube of Ø 6 cm. Ø 60 table net weight 13 kg (28,66 lb). Barcino Ø 80 cm with base of Ø 45 cm and tube of Ø 8 cm. Ø 80 table net weight 22 kg (48,50 lb).

Table pour usage intérieur et extérieur. Structure en aluminium anodisé peinte par pulvérisation et séchée au four 40 x 40 mm et 1,5 mm de grosseur. Plateau de 4 mm de grosseur. Barcino Ø 60 cm avec base de Ø 35 cm et tube de Ø 6 cm. Poids net table Ø 60, 13 kg. Barcino Ø 80 cm avec base de Ø 45 cm et tube de Ø 8 cm. Poids net table Ø 80, 22 kg.

Barcino Test Certificates:

AIDIMA UNE EN 15373:07 General Public Use / UNE EN 1728:01

Units STD	Packaging Dimensions (cm)	m3/ pack	NW Unit (kg)	Units Container 20'	Units Container 40'	Units Container HC	Units Traylor (70m3)	Units Truck 100m3
1	62x62x13	0,06	13	-	-	-	-	-
20	120x80x200	1,92	13	220	500	500	-	-
1	82x82x15	0,10	22	-	-	-	-	-
20	100x120x230	2,76	22	200	440	440	-	-

Ø 60 x H 74 cm  
Ø 23.62 x H 29.13 in

Ø 80 x H 74 cm  
Ø 31.49 x H 29.13 in



Negro  
Black  
Noir



Arena  
Sand  
Sable



Blanco  
White  
Blanc

Ø: diámetro / diameter / diamètre L: largo / length / longueur W: ancho / width / largeur H: altura / height / hauteur



taburete / stool / tabouret

# barcino

DESIGNED BY JOAN GASPAR

Barcelona Dd



Personalización de colores disponible bajo pedido y sujetos a cantidades mínimas. Consulte el Departamento Comercial.

Colour customization is available upon request. Minimum orders are applicable. Contact the Sales Department.

Personnalisation de couleurs disponible sur commande. Quantités minimales à appliquer. Consultez le département commerciale Département Commerciale.

ASOCIADO N°01684

**AIDIMA**  
INSTITUTO TECNOLÓGICO  
MUEBLE, MADERA, EMBALAJE Y AFINES

Taburete apilable para uso interior y exterior. Estructura, asiento y respaldo de aluminio anodizado pintado por pulverización y secado al horno. Estructura de 30 x 30 mm y 2 mm de grosor. Asiento y respaldo de 4 mm de grosor. Peso neto 4,80 kg.

Stackable stool for indoor and outdoor use. Powder coated anodized aluminium structure, seat and back. Structure of 30 x 30 mm and 2 mm thick. Seat and back of 4 mm thick. Barstool net weight 4,80 kg (10,58 lb).

Tabouret empilable pour usage intérieur et extérieur. Structure, siège et dossier en aluminium anodisé peints par pulvérisation et séchés au four. Structure de 30 x 30 mm et 2 mm de grosseur. Poids net tabouret 4,80 kg.

Barcino Test Certificates:

AIDIMA UNE EN 15373:07 General Public Use / UNE EN 1728:01

Units STD	Packaging Dimensions (cm)	m3/ pack	NW Unit (kg)	Units Container 20'	Units Container 40'	Units Container HC	Units Traylor (70m3)	Units Truck 100m3
4	50x41x13,6	0,23	4,80	-	-	-	-	-
40	100x120x220	2,64	4,80	440	1.000	1.000	-	-

**W** 36,7 x **L** 39,3 x **H** 99 x **Hs** 77 cm

**W** 14.45 x **L** 15.47 x **H** 38.98 x **Hs** 30.32 in



4 u.



Negro  
Black  
Noir



Arena  
Sand  
Sable



Blanco  
White  
Blanc

**W:** ancho / width / largeur **L:** largo / length / longueur **H:** altura / height / hauteur **Hs:** altura asiento / seat height / hauteur du siège





mesa pie central alto / high pedestal base table / table pied central haut

# barcino

DESIGNED BY JOAN GASPAR

Barcelona Dd

Personalización de colores disponible bajo pedido y sujetos a cantidades mínimas. Consulte el Departamento Comercial.

Colour customization is available upon request. Minimum orders are applicable. Contact the Sales Department.

Personnalisation de couleurs disponible sur commande. Quantités minimales à appliquer. Consultez le département commerciale Département Commerciale.



ASOCIADO N°01684  
**AIDIMA**  
 INSTITUTO TECNOLÓGICO  
 MUEBLE, MADERA, EMBALAJE Y AFINES

Mesa alta para uso interior y exterior. Estructura de aluminio anodizado pintado por pulverización y secado al horno de 40 x 40 mm y 1,5 mm de grosor. Sobre de 4 mm de grosor. Base de Ø 35 cm y tubo de Ø 6 cm. Peso neto mesa 14 kg.

High table for indoor and outdoor use. Powder coated anodized aluminium frame and oven-drying 40 x40 mm and 1,5 mm thick. Table top of 4 mm thickness. Base of Ø 35 cm and tube of Ø 6 cm. Table net weight 14 kg (30.86 lb).

Table pour usage intérieur et extérieur. Structure en aluminium anodisé peinte par pulvérisation et séchée au four 40 x 40 mm et 1,5 mm de grosseur. Plateau de 4 mm de grosseur. Base de Ø 35 cm avec tube de Ø 6 cm. Poids net table 14 kg.

Barcino Test Certificates:  
 AIDIMA UNE EN 15373:07 General Public Use / UNE EN 1728:01

Units STD	Packaging Dimensions (cm)	m3/ pack	NW Unit (kg)	Units Container 20'	Units Container 40'	Units Container HC	Units Traylor (70m3)	Units Truck 100m3
1	62x62x13	0,06	14	-	-	-	-	-
27	120x80x230	2,21	14	297	675	675	-	-

Ø 60 x H 110 cm  
 Ø 23.62 x H 43.31 in



Negro  
 Black  
 Noir



Arena  
 Sand  
 Sable



Blanco  
 White  
 Blanc

Ø: diámetro / diameter / diamètre L: largo / length / longueur W: ancho / width / largeur H: altura / height / hauteur

mesa cubitera / ice cube table / table glacière

# barcino

DESIGNED BY JOAN GASPAR

Personalización de colores disponible bajo pedido y sujetos a cantidades mínimas. Consulte el Departamento Comercial.

Colour customization is available upon request. Minimum orders are applicable. Contact the Sales Department.

Personnalisation de couleurs disponible sur commande. Quantités minimales à appliquer. Consultez le département commerciale Département Commerciale.



Mesa auxiliar de 50 x 45 cm para uso interior y exterior. Estructura de aluminio anodizado pintado por pulverización al horno, de 40 x 40 mm y 2 mm de grosor. Sobre de 3 mm de grosor. Contiene cubitera de policarbonato transparente negro. Peso neto 5,06 kg.

Auxiliary table 50 x 45 cm for indoor and outdoor use. Powder coated anodized aluminium frame, 40 x 40 mm and 2 mm thick. Table top of 3 mm thickness. With ice bucket. Net weight 5,06 kg (11.15 lb).

Table auxiliaire pour usage intérieur et extérieur. Structure en aluminium anodisé peint par pulvérisation au four, de 50 x 45 mm et 2 mm de grosseur. Avec seau à glace. Plateau de 3 mm de grosseur. Poids net 5,06 kg.

Units STD	Packaging Dimensions (cm)	m3/ pack	NW Unit (kg)	Units Container 20'	Units Container 40'	Units Container HC	Units Trayler (70m3)	Units Truck 100m3
1	60x50x40	0,12	5,06	-	-	-	-	-

**W** 50 x **L** 45 x **H** 35,8 cm

**W** 19.68 x **L** 17.72 x **H** 14,09 in



Negro  
Black  
Noir



Arena  
Sand  
Sable



Blanco  
White  
Blanc

**W:** ancho / width / largeur **L:** largo / length / longueur **H:** altura / height / hauteur **Hs:** altura asiento / seat height / hauteur du siège



tumbona / sunlounger / chaise longue

# barcino

DESIGNED BY JOAN GASPAR

Barcelona Dd



Personalización de colores disponible bajo pedido y sujetos a cantidades mínimas. Consulte el Departamento Comercial.

Colour customization is available upon request. Minimum orders are applicable. Contact the Sales Department.

Personnalisation de couleurs disponible sur commande. Quantités minimales à appliquer. Consultez le département commercialele Département Commerciale.



Tumbona apilable para uso interior y exterior. Estructura de aluminio anodizado pintado por pulverización al horno, de 40 x 40 mm y 2 mm de grosor. Textilene de 1.170 gr/m<sup>2</sup>, termosoldado para mayor resistencia, y trama y urdimbre de doble hilo. Reclinable en 5 posiciones, incluyendo posición extraplana ideal para estar tumbado boca abajo. Respaldo con tope de seguridad. Ruedas en patas traseras y tacos antideslizantes en las delanteras y traseras. Peso neto 19,25 kg.

Stackable sunlounger for indoor and outdoor use. Powder coated anodized aluminium frame, 40 x 40 mm and 2 mm thick. Textilene 1170 gr/m<sup>2</sup>, thermal bonding to improve resistance, double linen weft and warp. Five-position reclining sunlounger, including flat position. Back with safety stopper. Wheels under back legs and non-slip end-plates under front and back legs. Net weight 19,25 kg (42,44 lb).

Chaise longue empilable pour usage intérieur et extérieur. Structure en aluminium anodisé peinte par pulvérisation au four, de 40 x 40 mm et 2 mm de grosseur. Textilène de 1.170 gr/m<sup>2</sup>, termosoudé pour une meilleure résistance, et chaîne de double fil de trame et ourdir. Cinq positions du dossier, inclus position extraplate. Dossier avec arrêt de sécurité. Pieds arrière munis de roues et pieds avant et arrière munis de patins antidérapants. Poids net 19,25 kg.

Barcino Test Certificates:

BS EN 581-1: 2006. Contract Use.

BS EN 581-2: 2009. Contract Use.

Units STD	Packaging Dimensions (cm)	m <sup>3</sup> / pack	NW Unit (kg)	Units Container 20'	Units Container 40'	Units Container HC	Units Trayler (70m <sup>3</sup> )	Units Truck 100m <sup>3</sup>
2	220x80x50	0,88	19,25	56	120	150	-	-

W 74,5 x L 206,1 x H 35 cm

W 29,33 x L 81,14 x H 13.78 in



4 u.

Estructura / Structure / Structure:



Negro  
Black  
Noir



Arena  
Sand  
Sable



Blanco  
White  
Blanc

Textilene / Textilene / Textilène:



Negro  
Black  
Noir



Arena  
Sand  
Sable



Blanco  
White  
Blanc

W: ancho / width / largeur L: largo / length / longueur H: altura / height / hauteur







sofá / sofa / canapé

# barcino

DESIGNED BY JOAN GASPAR

novedad  
new nouveauté

Barcelona Dd



ASOCIADO N°01684  
**AIDIMA**  
INSTITUTO TECNOLÓGICO  
MUEBLE, MADERA, EMBAJALE Y AFINES

Sofá apilable para uso interior y exterior. Estructura de aluminio anodizado pintado por pulverización y secado al horno de 30x30 mm y 2 mm de grosor. Cojines de poliéster de color beige incluidos. Peso neto 16 kg.

Stackable sofa for indoor and outdoor use. Powder coated anodized aluminium structure of 30x30 mm and 2 mm of thickness. Polyester beige cushions included. Net weight 16 kg (35.27 lb)

Canapé empilable pour usage intérieur et extérieur. Structure en aluminium anodisé peinte par pulvérisation au four de 30x30 mm et 2 mm de grosueur. Coussins beige en polyester inclus. Poids net 16 kg.

Barcino Test Certificates:  
AIDIMA UNE EN 581-1:2006 Public  
AIDIMA UNE EN 581-2:2009 Public

Units STD	Packaging Dimensions (cm)	m3/ pack	NW Unit (kg)	Units Container 20'	Units Container 40'	Units Container HC	Units Traylor (70m3)	Units Truck 100m3
1	62x141x80	0,69	16	38	80	-	113	-

**W** 139 x **L** 59,7 x **H** 75,8 x **Hs** 35 x **Ha** 57 cm  
**W** 54.72 x **L** 23.5 x **H** 29.84 x **Hs** 13.78 x **Ha** 22.44 in

Negro	Arena	Blanco
Black	Sand	White
Noir	Sable	Blanc

**W:** ancho / width / largeur    **L:** largo / length / longueur    **H:** altura / height / hauteur    **Hs:** altura asiento / seat height / hauteur du siège

sillón / chair / fauteuil

# barcino

DESIGNED BY JOAN GASPAR

ASOCIADO N°01684  
**AIDIMA**  
INSTITUTO TECNOLÓGICO  
MUEBLE, MADERA, EMBALAJE Y MÁS

Sillón apilable para uso interior y exterior. Estructura de aluminio anodizado pintado por pulverización y secado al horno de 30x30 mm y 2 mm de grosor. Cojines de poliéster de color beige incluidos. Peso neto 9 kg.

Stackable armchair for indoor and outdoor use. Powder coated anodized aluminium structure of 30x30 mm and 2 mm of thickness. Polyester beige cushions included. Net weight 9 kg (19.85 lb)

Fauteuil empilable pour usage intérieur et extérieur. Structure en aluminium anodisé peinte par pulvérisation au four de 30x30 mm et 2 mm de grosseur. Coussins beige en polyester inclus. Poids net 9 kg.

Units STD	Packaging Dimensions (cm)	m3/ pack	NW Unit (kg)	Units Container 20'	Units Container 40'	Units Container HC	Units Trayler (70m3)	Units Truck 100m3
1	62x71x80	0,35	9	69	141	-	141	-

**W** 69 x **L** 59,7 x **H** 75,8 x **Hs** 37 cm

**W** 27.17 x **L** 23.50 x **H** 29.84 x **Hs** 13.78 x **Ha** 22.44 in



novedad  
new nouveauté

Barcelona Dd



Negro  
Black  
Noir



Arena  
Sand  
Sable



Blanco  
White  
Blanc

Barcino Test Certificates:  
AIDIMA UNE EN 581-1:2006 Public  
AIDIMA UNE EN 581-2:2009 Public

mesa de centro / coffee table / table basse

# barcino

DESIGNED BY JOAN GASPAR

ASOCIADO N°01684  
**AIDIMA**  
INSTITUTO TECNOLÓGICO  
MUEBLE, MADERA, EMBALAJE Y MÁS

Mesa de centro apilable para uso interior y exterior. Estructura de aluminio anodizado pintado por pulverización y secado al horno de 30x30 mm y 2 mm de grosor. Tablero de 3 mm de grosor. Peso neto 8 kg.

Stackable coffee table for indoor and outdoor use. Powder coated anodized aluminium structure of 30x30 mm and 2 mm of thickness. Table top of 3 mm thickness. Net weight 8 kg (17.64 lb).

Table basse empilable pour usage intérieur et extérieur. Structure en aluminium anodisé peinte par pulvérisation au four de 30x30 mm et 1,5 mm de grosseur. Plateau de 3 mm de grosor. Poids net 8 kg.

Units STD	Packaging Dimensions (cm)	m3/ pack	NW Unit (kg)	Units Container 20'	Units Container 40'	Units Container HC	Units Trayler (70m3)	Units Truck 100m3
1	64x103x39	0,29	8	120	250	-	290	-

**L** 101 x **W** 60 x **H** 35,8 cm

**L** 39.76 x **W** 23.62 x **H** 14.09 in



novedad  
new nouveauté



Negro  
Black  
Noir



Arena  
Sand  
Sable



Blanco  
White  
Blanc

Barcino Test Certificates:  
AIDIMA UNE EN 581-1:2006 Public  
AIDIMA UNE EN 581-3:07 Public

**W:** ancho / width / largeur    **L:** largo / length / longueur    **H:** altura / height / hauteur    **Hs:** altura asiento / seat height / hauteur du siège







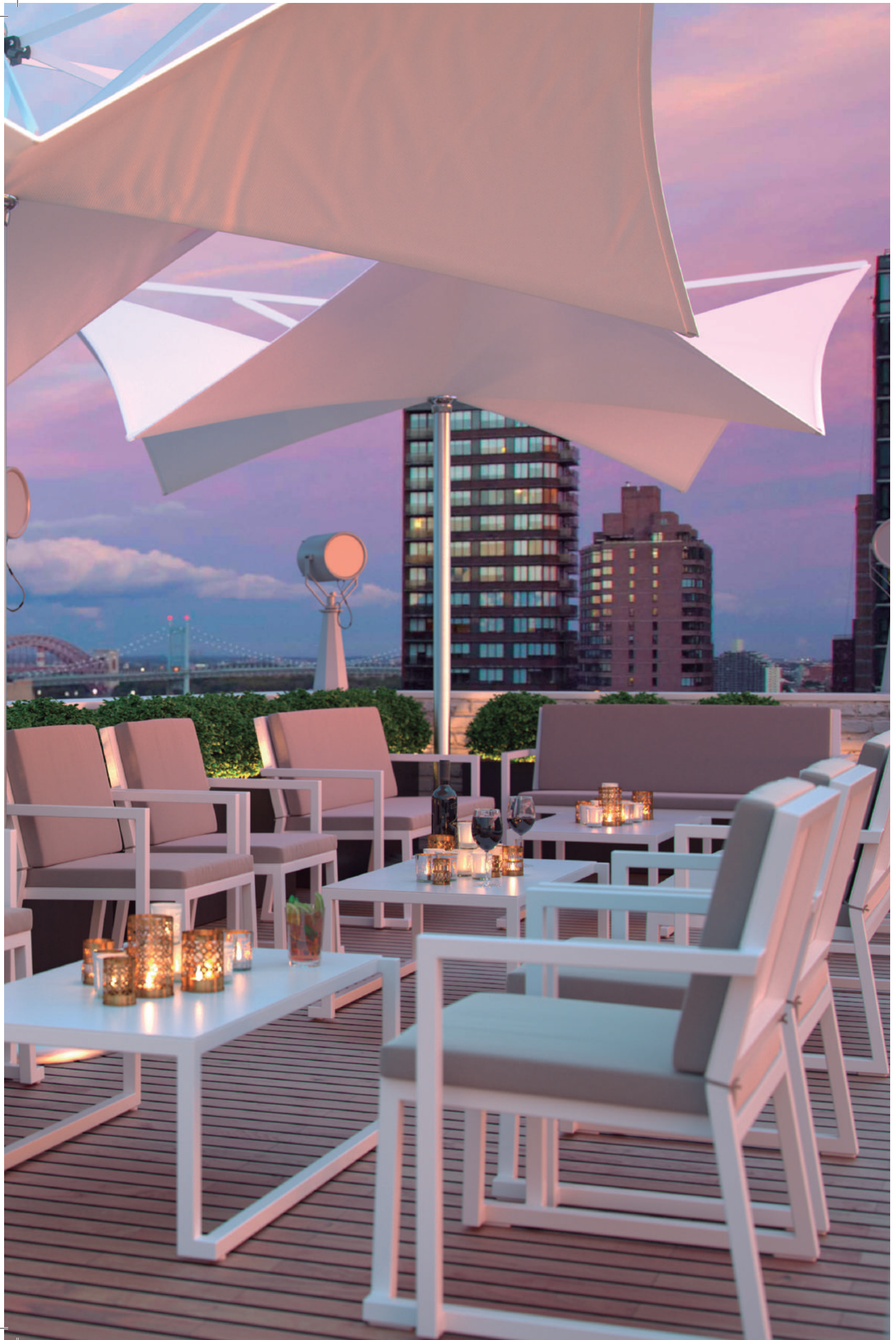



pie central / pedestal base / pied central

# vela S

DESIGNED BY FABRIZIO BATONI

Barcelona Dd

ASOCIADO N°01684

**AIDIMA**  
INSTITUTO TECNOLÓGICO  
MUEBLE, MADERA, EMBALAJE Y AFINES

**HO** 18TH ANNUAL IIDA/HO  
Product Design  
Competition  
IIDA hospitality  
2014 WINNER

interior  
innovation  
award  
2014  
Winner



Pie central para uso interior y exterior compuesto por dos bases inyectadas en fibra de vidrio con PP mediante tecnología de moldeo asistida por gas, unidas por una barra de aluminio. Protección UV. Peso neto 4 kg. Pie compatible con sobres de compacto fenólico y cristal templado de 70x70, 80x80, 90x90, Ø70 y Ø80. Ver tabla de combinaciones en página 106.

Pedestal base for indoor and outdoor use, composed by two bases injected in fiberglass with PP using gas assisted injection moulding technology, joined by an aluminium bar. UV Protection. Net weight 4 kg (8.82 lb). Compatible base with HPL and tempered glass table tops of 70x70, 80x80, 90x90, Ø70 and Ø80 cm. See table combinations on page 106.

Pied central pour usage intérieur et extérieur, composé par deux bases injectées en fibre de verre avec PP, en utilisant technologie de moulage assistée par gaz, unies par une barre en aluminium. Protection UV. Poids net 4 kg. Pied compatible avec plateaux de résine phénolique et verre trempé de 70x70, 80x80, 90x90, Ø70 et Ø80. Voir table de combinaisons à la page 106.

Vela S Test Certificates:

AIDIMA UNE EN 15372:2008 Level 3

AIDIMA UNE EN 1730:2013 Level 3

Units STD	Packaging Dimensions (cm)	m3/ pack	NW Unit (kg)	Units Container 20'	Units Container 40'	Units Container HC	Units Trayler (70m3)	Units Truck 100m3
1	83x74x27	0,166	4	-	-	-	-	-

L 61,5 x W 60 x H 72,50 cm

L 24.21 x W 23.62 x H 28.54 in



Negro  
Black  
Noir



Arena  
Sand  
Sable



Blanco  
White  
Blanc



Rojo  
Red  
Rouge

W: ancho / width / largeur L: largo / length / longueur H: altura / height / hauteur

pie central doble / double pedestal base / double pied central

# vela M

DESIGNED BY FABRIZIO BATONI



ASOCIADO N°01684

**AIDIMA**  
INSTITUTO TECNOLÓGICO  
MUEBLE, MADERA, EMBALAJE Y AFINES

**HD** 18TH ANNUAL IIDA/HD  
Product Design  
Competition  
2014 WINNER

interior  
innovation  
award  
2014  
Winner

Pie central doble para uso interior y exterior compuesto por dos bases inyectadas en fibra de vidrio con PP mediante tecnología de moldeo asistida por gas, enlazadas entre sí por una barra de aluminio cubierto por un perfil de pvc texturizado. Protección UV. Peso neto 4,65 kg. Base compatible con sobres de compacto fenólico y cristal templado de 120x80. Ver tabla de combinaciones en página 106.

Double pedestal base for indoor and outdoor use, composed by two bases injected in fibreglass with PP using gas assisted injection moulding technology, joined by an aluminium bar covered by a textured pvc profile. UV Protection. Net weight 4,65 kg (10.25 lb). Compatible base with HPL and tempered glass table tops of 120x80 cm. See table combinations on page 106.

Double pied central pour usage intérieur et extérieur, composé par deux bases injectées en fibre de verre avec PP, en utilisant technologie de moulage assistée par gaz, unies par une barre en aluminium couverte avec un profil de pvc texturé. Protection UV. Poids net 4,65 kg. Pied compatible avec plateaux de résine phénolique et verre trempé de 120x80. Voir table de combinaisons à la page 106.

Vela M Test Certificates:  
AIDIMA UNE EN 15372:2008 Level 3  
AIDIMA UNE EN 1730:2013 Level 3

Units STD	Packaging Dimensions (cm)	m3/ pack	NW Unit (kg)	Units Container 20'	Units Container 40'	Units Container HC	Units Trayler (70m3)	Units Truck 100m3
1	83x74x27	0,166	4,65	-	-	-	-	-

L 61,5 x W 79 x H 72,50 cm

L 24.21 x W 31.1 x H 28.54 in



Negro  
Black  
Noir



Arena  
Sand  
Sable



Blanco  
White  
Blanc



Rojo  
Red  
Rouge

W: ancho / width / largeur L: largo / length / longueur H: altura / height / hauteur



pie central doble / double pedestal base / pied central double

# vela L

DESIGNED BY FABRIZIO BATONI

Barcelona Dd

ASOCIADO N°01684

**AIDIMA**  
INSTITUTO TECNOLÓGICO  
MUEBLE, MADERA, EMBALAJE Y AFINES

**HO** 18TH ANNUAL IIDA/HD  
Product Design  
Competition  
2014 WINNER

interior  
innovation  
award  
2014  
Winner



Pie central doble para uso interior y exterior compuesto por dos bases inyectadas en fibra de vidrio con PP mediante tecnología de moldeo asistida por gas, enlazadas entre sí por una barra de aluminio cubierto por un perfil de pvc texturizado. Protección UV. Peso neto 5,9 kg. Base compatible con sobres de compacto fenólico de 180x90 y 200x90, y cristal templado de 180x90 cm. Ver tabla de combinaciones en página 106.

Double pedestal base for indoor and outdoor use, composed by two bases injected in fibreglass with PP using gas assisted injection moulding technology, joined by an aluminium bar covered by a textured pvc profile. UV Protection. Net weight 5,9 kg (13 lb). Compatible base with HPL table tops of 180x90 and 200x90, and tempered glass table tops of 180x90 cm. See table combinations on page 106.

Pied central double pour usage intérieur et extérieur, composé par deux bases injectées en fibre de verre avec PP, en utilisant technologie de moulage assistée par gaz, unies par une barre en aluminium couverte avec un profil de pvc texturé. Protection UV. Poids net 5,9 kg. Pied compatible avec plateaux de résine phénolique de 180x90 et 200x90, et de verre trempé de 180x90. Voir table de combinaisons à la page 106.

Vela L Test Certificates:  
AIDIMA UNE EN 15372:2008 Level 3  
AIDIMA UNE EN 1730:2013 Level 3

Units STD	Packaging Dimensions (cm)	m3/ pack	NW Unit (kg)	Units Container 20'	Units Container 40'	Units Container HC	Units Traylor (70m3)	Units Truck 100m3
1	83x74x27	0,166	5,9	-	-	-	-	-

L 61,5 x W 142 x H 72,50 cm  
L 24.21 x W 55.91 x H 28.54 in



Negro  
Black  
Noir



Arena  
Sand  
Sable



Blanco  
White  
Blanc



Rojo  
Red  
Rouge

W: ancho / width / largeur L: largo / length / longueur H: altura / height / hauteur





pie central / pedestal base / pied central

# net

DESIGNED BY LLUÍS CODINA

Barcelona Dd

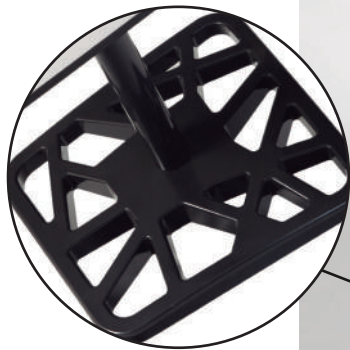

Pie central para uso interior y exterior. Pie en inyección de aluminio pintado blanco y negro. Protección contra rayos UV. Consultar tabla de combinaciones de pie y sobres en pág. 106.

Pedestal base for indoor and outdoor use. Cast aluminium pedestal base, white and black painted. UV protection. See table combination for pedestal bases and table tops on p. 106.

Pied central d'intérieur et extérieur. Pied central injecté en aluminium peint en blanc et noir. Voir le tableau de combinaison pour pied central et plateau pag. 106.

## Pie Net / Net pedestal base / Pied central Net

Base 50,30 x 51 x 44 x 46 cm (19.80 x 20.08 x 17.32 x 18.11 in) x H 69,20 cm (27.24 in)  
16,20 kg (35.72 lb)

Units STD	Packaging Dimensions (cm)	m3/ pack	NW Unit (kg)	Units Container 20'	Units Container 40'	Units Container HC	Units Traylor (70m3)	Units Truck 100m3
1	53x55x17	0,05	16,2	565	1.171	1.320	1.414	2.020

pie / pedestal base / pied central



aluminio pintado blanco / white painted aluminium / aluminium peint en blanc



aluminio pintado negro / black painted aluminium / aluminium peint en noir

W: ancho / width / largeur L: largo / length / longueur H: altura / height / hauteur



Barcelona Dd



mesa apilable / stackable table / table empilable

novedad  
new nouveauté

# point

DESIGNED BY JOAN GASPAR





Barcelona Dd



Mesa para uso interior y exterior. El sobre se compone de 2 partes inyectadas en PP. Estructura tubular de acero pintado por pulverización al horno, disponible en color blanco. Apilable. Protección UV. Peso neto 70x70: 10,66 kg y peso neto 80x80: 12 kg.

Table for indoor and outdoor use. The table top is composed by two layers injected in PP. Tubular powder coated steel structure, available in white. Stackable. UV protection. Net Weight 70x70: 10,66 kg (23.50 lb) and net weight 80x80: 12 kg (26.46 lb).

Table d'intérieur et extérieur. Le plateau est fait en deux parties injectées en PP. Structure tubulaire en acier peint par pulvérisation, disponible en couleur blanche. Empilable. Protection UV. Poids net 70x70: 10,66 kg et poids net 80x80: 12 kg.

base	tapa / surface / revêtement		
			
Blanco White Blanc	Rojo Red Rouge	Blanco White Blanc	Negro Black Noir

Units STD	Packaging Dimensions (cm)	m3/ pack	NW Unit (kg)	Units Container 20'	Units Container 40'	Units Container HC	Units Traylor (70m3)	Units Truck 100m3
15	110x110x210	2,54	10,66	150	300	330	360	390
15	110x110x210	2,54	12	150	300	330	360	390

W 70 x L 70 x H 70,50 cm

W 27.56 x L 27.56 x H 27.76 in

W 80 x L 80 x H 70,50 cm

W 31.50 x L 31.50 x H 27.76 in



W: ancho / width / largeur L: largo / length / longueur H: altura / height / hauteur





pie central simple / single pedestal base / pied central simple

# sputnik

DESIGNED BY JOSEP LLUSCÀ

Barcelona Dd



Pie central simple para uso interior y exterior. El pie se compone de dos partes, una carcasa inyectada en poliamida y un contrapeso de hierro pintado. Tubo de aluminio anodizado de  $\varnothing$  60 x 2 mm de grosor. Protección contra rayos UV. Nivelador en una pata. Consultar tabla de combinaciones de pie y sobres en pág. 106.

Single pedestal base for indoor and outdoor use. The base is composed of two pieces, a casing injected with polyamide and a painted iron counterweight. Anodized aluminium tube,  $\varnothing$  60 x 2 mm thick. UV protection. Leveller in one leg. See table combination for pedestal bases and table tops on p. 106.

Pied central simple d'intérieur et extérieur. Pied central fait en deux parts, une carcasse injectée en polyamide et un contrepoids en fer, peint. Tube en aluminium anodisé brillant ou mat, ou tube en aluminium peint blanc ou noir de  $\varnothing$  60 x 2 mm de grosseur. Protection contre les rayons UV. Niveleur sur un pied. Voir table de combinaisons entre pied central et plateau à la page 106.

STD	Packaging Dimensions (cm)	m3/ pack	NW Unit (kg)	Units Container 20'	Units Container 40'	Units Container HC	Units Trayler (70m3)	Units Truck 100m3
1	53x55x17	0,05	5,64	565	1.171	1.320	1.414	2.020

pie / pedestal base / pied central



Blanco  
White  
Blanc

Rojo  
Red  
Rouge

Negro  
Black  
Noir

acabados tubos / tube finishes / finition du tube



aluminio brillante / shiny aluminium / aluminium brillant



aluminio mate / matt aluminium / aluminium mat



aluminio pintado blanco / white painted aluminium / aluminium peint en blanc



aluminio pintado negro / black painted aluminium / aluminium peint en noir

Pie Sputnik simple / single Sputnik pedestal base / pied central Sputnik simple

L 52 cm (20.47 in) x W 52 (20.47 in) x H 68,50 cm (26.97 in) 5,64 kg (12.41 lb)

$\varnothing$ : diámetro / diameter / diamètre L: largo / length / longueur W: ancho / width / largeur H: altura / height / hauteur





pie central alto / high pedestal base / pied central haut

# sputnik

DESIGNED BY JOSEP LLUSCÀ

Barcelona Dd



Pie central alto para uso interior y exterior. El pie se compone de dos partes, una carcasa inyectada en poliamida y un contrapeso de hierro pintado. Tubo de aluminio anodizado de  $\phi$  60 x 2 mm. de grosor en acabado brillante, mate o pintado blanco o negro. Protección contra rayos UV. Nivelador en una pata. Consultar tabla de combinaciones de pie y sobres en pág. 106.

High pedestal base for indoor and outdoor use. The base is composed of two pieces, a casing injected with polyamide and a painted iron counterweight. Anodized aluminium tube,  $\phi$  60 x 2 mm thick, shiny, matt or white or black painted finish. UV protection. Leveller in one leg. See table combination for pedestal bases and table tops on p. 106.

Pied central haut d'intérieur et extérieur. Pied central fait en deux partis, une carcasse injectée en polyamide et un contrepois en fer, peint. Tube en aluminium anodisé brillant ou mat, ou tube en aluminium peint blanc ou noir de  $\phi$  60 x 2 mm de grosseur. Protection contre les rayons UV. Niveleur sur un pied. Voir table de combinaisons pour pieds central et plateau à la page 106.

## Pie Sputnik alto / High Sputnik pedestal base / pied central Sputnik haut

L 52 cm (20.47 in) x W 52 (20.47 in) x H 107 cm (42.13 in) 6,78 kg (14.92 lb)

Units STD	Packaging Dimensions (cm)	m <sup>3</sup> /pack	NW Unit (kg)	Units Container 20'	Units Container 40'	Units Container HC	Units Trayler (70m <sup>3</sup> )	Units Truck 100m <sup>3</sup>
1	box 1 53x55x17 box 2 96x7x7	0,075+0,005	6,78	350	725	822	875	1.250

### pie / pedestal base / pied central



Blanco  
White  
Blanc



Rojo  
Red  
Rouge



Negro  
Black  
Noir

### acabados tubos / tube finishes / finition du tube



aluminio brillante / shiny aluminium / aluminium brillant



aluminio mate / matt aluminium / aluminium mat



aluminio pintado blanco / white painted aluminium / aluminium peint en blanc



aluminio pintado negro / black painted aluminium / aluminium peint en noir

$\phi$ : diámetro / diameter / diamètre L: largo / length / longueur W: ancho / width / largeur H: altura / height / hauteur

pie central doble / double pedestal base / pied central double

# sputnik

DESIGNED BY JOSEP LLUSCÀ



Barcelona Dd

Pie central doble para uso interior y exterior. El pie se compone de dos partes, una carcasa inyectada en poliamida y un contrapeso de hierro pintado. Tubo de aluminio anodizado de  $\varnothing$  60 x 2 mm. de grosor en acabado brillante, mate o pintado blanco o negro. Protección contra rayos UV. Nivelador en una pata. Consultar tabla de combinaciones de pie y sobres en pág. 106.

Double pedestal base for indoor and outdoor use. The base is composed of two pieces, a casing injected with polyamide and a painted iron counterweight. Anodized aluminium tube,  $\varnothing$  60 x 2 mm thick, shiny, matt or white or black painted finish. UV protection. Leveller in one leg. See table combination for pedestal bases and table tops on p. 106.

Pied central double d'intérieur et extérieur. Pied central fait en deux parties, une carcasse injectée en polyamide et un contrepoids en fer, peint. Tube en aluminium anodisé brillant ou mat, ou tube en aluminium peint blanc ou noir de  $\varnothing$  60 x 2 mm de grosseur. Protection contre les rayons UV. Niveleur sur un pied. Voir table de combinaisons pour pied central et plateau à la page 106.

## Pie Sputnik doble / Double Sputnik pedestal base / pied central Sputnik double

L 102 cm (40.16 in) x W 63,50 (25 in) x H 68,50 cm (26.97 in) 7,84 kg (17.25 lb)

Units STD	Packaging Dimensions (cm)	m3/pack	NW Unit (kg)	Units Container 20'	Units Container 40'	Units Container HC	Units Traylor (70m3)	Units Truck 100m3
1	102x65x17	0,11	7,84	248	514	583	621	887

### pie / pedestal base / pied central



Blanco  
White  
Blanc



Negro  
Black  
Noir

### acabados tubos / tube finishes / finition du tube



aluminio brillante / shiny aluminium / aluminium brillant



aluminio mate / matt aluminium / aluminium mat



aluminio pintado blanco / white painted aluminium / aluminium peint en blanc





















aluminio pintado negro / black painted aluminium / aluminium peint en noir

L: largo / length / longueur W: ancho / width / largeur H: altura / height / hauteur





								
		Vela S	Vela M	Vela L	Net	Sputnik	Sputnik alto	Sputnik doble
<b>COMPACTO FENÓLICO</b>   	Ø 60					✓	✓	
	Ø 70	✓				✓		
	Ø 80	✓				✓		
	60 x 60					✓		
	70 x 70	✓			✓	✓		
	80 x 80	✓			✓			
	90 x 90	✓			✓			
	120 x 80		✓					✓
	180 x 90			✓				✓
200 x 90			✓					
<b>WERZALIT</b>    	Ø 60					✓	✓	
	60 x 60					✓		
	70 x 70				✓	✓		
	80 x 80				✓			
	90 x 90				✓			
	120 X 80							✓
<b>DUROLIGHT</b>   	68 x 68					✓		
	80 x 80				✓			
<b>CRISTAL TEMPLADO</b> 	Ø 70	✓						
	Ø 80	✓						
	70 x 70	✓						
	80 x 80	✓						
	90 x 90	✓						
	120 x 80		✓					
	180 x 90			✓				

Las combinaciones disponibles han sido revisadas y aprobadas por el departamento técnico. Para productos destinados a zonas de alta salinidad consultar previamente con departamento comercial.  
 The combinations available have been reviewed and approved by the technical department. Ask previously sales dept. for using our products in high salinity areas.  
 Les combinaisons disponibles ont été examinées et approuvées par le département technique. Produits destinés aux zones de haute salinité consulter à l'avance au dép. commercial.







mesa plegable / folding table / table pliante

# space

DESIGNED BY BARCELONA Dd

Barcelona Dd



Mesa para uso interior y exterior. Sobre inyectado en polipropileno. Protección UV. Estructura plegable de acero pintado por pulverización. Mesa 90x90, peso neto 13 kg. Mesa 160x90, peso neto 18,60 kg.

Table for indoor and outdoor use. Table top injected in polypropylene. UV Protection. 90x90 table, net weight 13kg (28.66 lb). 160x90 table, net weight 18,60kg (41 lb).

Table d'intérieur et extérieur. Plateau injecté en polypropylène. Protection UV. Table 90x90, poids net 13 kg. Table 160x90, poids net 18,60 kg.

Units STD	Packaging Dimensions (cm)	m3/ pack	NW Unit (kg)	Units Container 20'	Units Container 40'	Units Container HC	Units Trayler (70m3)	Units Truck 100m3
1	92x94x10	0,086	13	380	540	540	680	980
1	161x92x10	0,148	18,60	260	400	460	560	700

**L** 90 x **W** 90 x **H** 74 cm

**L** 35.43 x **W** 35.43 x **H** 29.13 in

**L** 160 x **W** 90 x **H** 74 cm

**L** 62.99 x **W** 35.43 x **H** 29.13 in



Blanco  
White  
Blanc

**L**: largo / length / longueur **W**: ancho / width / largeur **H**: altura / height / hauteur

mesa / table / table

# new dessa

DESIGNED BY BARCELONA Dd

Estabilidad mejorada.  
Improved stability.  
Stabilité améliorée.



ASOCIADO N°01684  
**AIDIMA**  
INSTITUTO TECNOLÓGICO  
MUEBLE, MADERA, EMBALAJE Y AFINES

Mesa para uso interior y exterior. Sobre y patas inyectados en polipropileno. Estructura metálica pintada por pulverización al horno. Protección contra rayos UV. Disponible en 2 medidas. Mesa Dessa 90x90, peso 11,74 kg. Mesa Dessa 160x90, peso 16,75 kg.

Table for indoor and outdoor use. Table top and legs injected in polypropylene. Powder coated metal structure. UV protection. Available in two different sizes. Table Dessa 90x90, weight 11,74 kg (25,88 lb). Table Dessa 160x90, weight 16,75 kg (36,93 lb).

Table pour usage intérieur et extérieur. Plateau et pieds injectés en polypropylène. Structure métallique peint par pulvérisation au four. Disponible dans 2 mesures. Table Dessa 90x90, poids 11,74 kg. Table Dessa 160x90, poids 16,75 kg.

Dessa Table Test Certificates:  
Seat static loading test according to EN 581 PUBLIC - 2012

Units STD	Packaging Dimensions (cm)	m3/ pack	NW Unit (kg)	Units Container 20'	Units Container 40'	Units Container HC	Units Traylor (70m3)	Units Truck 100m3
1	92x94x15	0,126	11,74	192	392	392	446	795
1	161x92x15	0,22	16,75	130	262	300	342	468

**L** 90 x **W** 90 x **H** 74 cm  
**L** 35.43 x **W** 35.43 x **H** 29.13 in  
**L** 160 x **W** 90 x **H** 74 cm  
**L** 62.99 x **W** 35.43 x **H** 29.13 in



Blanco  
White  
Blanc



Chocolate  
Chocolate  
Chocolat

**L:** largo / length / longueur **W:** ancho / width / largeur **H:** altura / height / hauteur











mesa / table / table

# new flash

DESIGNED BY BARCELONA Dd

Barcelona Dd



Estabilidad mejorada.  
Improved stability.  
Stabilité améliorée.

Mesa para uso interior y exterior. Sobre inyectado en polipropileno. Patas de aluminio anodizado de alta resistencia. Estructura metálica pintada por pulverización al horno. Protección contra rayos UV. Disponible en 2 medidas. Mesa Flash 90x90, peso 11,58 kg. Mesa Flash 160x90, peso 16,59 kg.

Table for indoor and outdoor use. Table top injected with polypropylene. High-resistance anodized aluminium legs. Powder coated metal structure. UV protection. Available in two different sizes. Table Flash 90x90, weight 11,58 kg. (25.53 lb). Table Flash 160x90, weight 16,59 kg. (36,57 lb).

Table d'intérieur et extérieur. Plateau injecté en polypropylène. Pieds en aluminium anodisé d'haute résistance. Structure métallique peinte par pulvérisation au four. Protection contre les rayons UV. Disponible dans 2 mesures. Table Flash 90x90, poids 11,58 kg. Table Flash 160x90, poids 16,59 kg.

Units STD	Packaging Dimensions (cm)	m3/ pack	NW Unit (kg)	Units Container 20'	Units Container 40'	Units Container HC	Units Trayler (70m3)	Units Truck 100m3
1	92x94x15	0,126	11,58	150	360	384	416	795
1	161x92x15	0,22	16,59	130	262	300	342	468

L 90 x W 90 x H 72 cm

L 35.43 x W 35.43 x H 28.34 in

L 160 x W 90 x H 72 cm

L 62.99 x W 35.43 x H 28.34 in



Blanco  
White  
Blanc



Chocolate  
Chocolate  
Chocolat

L: largo / length / longueur W: ancho / width / largeur H: altura / height / hauteur







sillón infantil / child armchair / fauteuil pour enfant

novedad  
new nouveauté

# rita

DESIGNED BY BARCELONA Dd

Asiento infantil.  
Child seat.  
Siège pour  
enfant.



Sillón para uso interior y exterior, inyectada en polipropileno. Apilable.  
Protección contra rayos UV. Peso neto 1,31 kg.  
Box pallet 66 unidades.

Armchair for indoor and outdoor use. Injected with polypropylene. Stackable.  
UV protection. Net weight 1,31 kg. (2.89 lb).  
Box pallet 66 units.

Fauteuil d'intérieur et/ou extérieur. Injectée en polypropylène. Empilable.  
Protection contre les rayons UV. Poids net 1,31 kg.  
Box palette 66 unités.

Units STD	Packaging Dimensions (cm)	m3/ pack	NW Unit (kg)	Units Container 20'	Units Container 40'	Units Container HC	Units Trayler (70m3)	Units Truck 100m3
4	39,5x41x78	0,13	1,31	1.032	2.184	2.304	3.508	-
204	120x80x220	2,11	1,31	2.244	5.100	5.100	6.732	-
66	120x80x120	1,15	1,31	1.452	3.300	3.300	5.016	-

**W** 38.7 x **L** 40.3 x **H** 59.7 x **Hs** 31.4 cm  
**W** 15.24 x **L** 15.87 x **H** 23.51 x **Hs** 12.36 in



Rojo  
Red  
Rouge



Naranja  
Orange  
Orange



Verde lima  
Lime green  
Vert citron



Rosa  
Pink  
Rose



Azul cielo  
Light blue  
Bleu ciel

**W:** ancho / width / largeur **L:** largo / length / longueur **H:** altura / height / hauteur **Hs:** altura asiento / seat height / hauteur du siège





silla infantil / child seat / siège pour enfant

# julieta

DESIGNED BY JOAN GASPAR

Asiento infantil.  
Child seat.  
Siège pour enfant.



Silla para uso interior y exterior, inyectada en polipropileno. Apilable.  
Protección contra rayos UV. Peso neto 1,18 kg.

Box pallet (60 unidades):

20 verde lima / 10 azul cielo / 10 rosa / 10 naranja / 10 roja.

Chair for indoor and outdoor use. Injected with polypropylene. Stackable.  
UV protection. Net weight 1,18 kg. (2.60 lb).

Box pallet (60 units):

20 lime green / 10 light blue / 10 pink / 10 orange / 10 red.

Chaise d'intérieur et/ou extérieur. Injectée en polypropylène. Empilable.  
Protection contre les rayons UV. Poids net 1,18 kg.

Box pallet (60 unités):

20 vert lime / 10 bleu ciel / 10 rose / 10 orange / 10 rouge.

Julieta PP chair Test Certificates:

Test NF D60 - 300 - 1 éd. 2008

Test NF D60 - 300 - 2 éd. 2008

Units STD	Packaging Dimensions (cm)	m3/ pack	NW Unit (kg)	Units Container 20'	Units Container 40'	Units Container HC	Units Trayler (70m3)	Units Truck 100m3
4	39,5x41x78	0,13	1,18	1.032	2.184	2.304	2.456	3.508
192	80x120x222	2,9	1,18	2.112	4800	4800	6336	7296
60	80x120x120	1,13	1,18	1.320	3.000	3.000	3.960	4.560

W 37,5 x L 40 x H 58 x Hs 31,6 cm

W 14.76 x L 15.75 x H 22.83 x Hs 12.44 in



Rojo  
Red  
Rouge



Naranja  
Orange  
Orange



Verde lima  
Lime green  
Vert citron



Rosa  
Pink  
Rose



Azul cielo  
Light blue  
Bleu ciel

W: ancho / width / largeur L: largo / length / longueur H: altura / height / hauteur Hs: altura asiento / seat height / hauteur du siège

mesa monobloc / monobloc table / table monobloc

# julieta

DESIGNED BY JOAN GASPAR



Barcelona Dd

Mesa monobloc para uso interior y exterior. Inyectada en polipropileno. Apilable. Protección contra rayos UV. Peso neto 1,70 kg.

Box pallet (15 unidades): 3 verde lima / 3 azul cielo / 3 rosa / 3 naranja / 3 roja.

Monobloc table for indoor and outdoor use. Injected with polypropylene. Stackable. Uv protection. Net weight 1,70 kg. (3.75 lb).

Box pallet (15 units): 3 lime green / 3 light blue / 3 pink / 3 orange / 3 red.

Table monobloc d'intérieur et extérieur. Injectée en polypropylène Empilable.

Protection contre les rayons UV. Poids net 1,70 kg.

Box palette (15 unités): 3 vert lime / 3 bleu ciel / 3 rose / 3 orange / 3 rouge.

Julieta Table Test Certificates:

Test NF D60 - 300 - 1 éd. 2008

Test NF D60 - 300 - 2 éd. 2008

Units STD	Packaging Dimensions (cm)	m3/ pack	NW Unit (kg)	Units Container 20'	Units Container 40'	Units Container HC	Units Trayler (70m3)	Units Truck 100m3
4	60x60x63 cm	0,23	1,7	324	720	960	1.400	1.600
80	80x120x213 cm	2,04	1,7	1.080	2.160	2.560	2.640	3.040
15	80x60x120	0,56	1,7	750	1.500	1.755	1.980	2.280

L 50 x W 50 x H 49 cm

L 19.69 x W 19.69 x H 19.29 in



Rojo  
Red  
Rouge



Naranja  
Orange  
Orange



Verde lima  
Lime green  
Vert citron



Rosa  
Pink  
Rose



Azul cielo  
Light blue  
Bleu ciel

W: ancho / width / largeur L: largo / length / longueur H: altura / height / hauteur









Barcelona Dd



sofá / sofa / canapé

# click-clack

DESIGNED BY JOSEP LLUSCÀ

Barcelona Dd



ASOCIADO N°01684

**AIDIMA**  
INSTITUTO TECNOLÓGICO  
MUEBLE, MADERA, EMBALAJE Y JIFINES

FURNITURE  
EXCELLENCE  
AWARD  
**MIFF**  
2014 WINNER

Sofá para uso interior y exterior. Inyectado en fibra de vidrio con PP mediante tecnología de moldeo asistida por gas. Protección contra rayos UV. Se entrega desmontado en un óptimo packaging. Cojines opcionales. Peso neto 15 kg.

Sofa for indoor and outdoor use. Injected in fiberglass with PP using gas assisted injection moulding technology. UV Protection. Delivered unassembled in an optimal packaging. Optional cushions. Net weight 15 kg (33.07 lb).

Canapé d'intérieur et extérieur. Injecté en fibre de verre avec PP, en utilisant technologie de moulage assistée par gaz. Protection UV. Livré démonté dans un packaging optimal. Coussins optionnels. Poids net 15 kg.

Click-Clack Test Certificates:

AIDIMA UNE EN 581-1:2006 Public

AIDIMA UNE EN 581-2:2009 Public

Units STD	Packaging Dimensions (cm)	m3/ pack	NW Unit (kg)	Units Container 20'	Units Container 40'	Units Container HC	Units Trayler (70m3)	Units Truck 100m3
1	40x15x74	0,34	15	66	150	150	198	240

## Cojín sofá Click-Clack

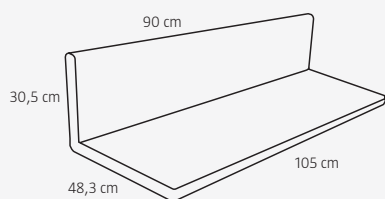

Cojín de algodón y poliéster de 5 cm de grosor en color beige para exterior.

Cotton and polyester cushion 5 cm thickness in beige colour for outdoor use.

Coussin polyester et coton de 5 cm de grosseur de couleur beige pour extérieur.

**W** 124 x **L** 64,5 x **H** 72,5 x **Hs** 42 cm

**W** 48.82 x **L** 25.39 x **H** 28.54 x **Hs** 16.54 in



Negro  
Black  
Noir



Blanco  
White  
Blanc



Arena  
Sand  
Sable



Chocolate  
Chocolate  
Chocolat

**W:** ancho / width / largeur **L:** largo / length / longueur **H:** altura / height / hauteur **Hs:** altura asiento / seat height / hauteur du siège

sillón / armchair / fauteuil

# click-clack

DESIGNED BY JOSEP LLUSCÀ



ASOCIADO N°01684

**AIDIMA**  
INSTITUTO TECNOLÓGICO  
MUEBLE, MADERA, EMPALME Y AFINES



Sillón para uso interior y exterior. Inyectado en fibra de vidrio con PP mediante tecnología de moldeo asistida por gas. Protección contra rayos UV. Se entrega desmontado en un óptimo packaging. Cojines opcionales. Peso neto 10,5 kg.

Armchair for indoor and outdoor use. Injected in fiberglass with PP using gas assisted injection moulding technology. UV Protection. Delivered unassembled in an optimal packaging. Optional cushions. Net weight 10,5 kg (23,15 lb).

Fauteuil d'intérieur et extérieur. Injecté en fibre de verre avec PP, en utilisant technologie de moulage assistée par gaz. Protection UV. Livré démonté dans un packaging optimal. Coussins optionnels. Poids net 10,5 kg.

Click-Clack Test Certificates:  
AIDIMA UNE EN 581-2:2009 Public

Units STD	Packaging Dimensions (cm)	m <sup>3</sup> / pack	NW Unit (kg)	Units Container 20'	Units Container 40'	Units Container HC	Units Traylor (70m <sup>3</sup> )	Units Truck 100m <sup>3</sup>
1	40x80x74	0,237	10,5	99	225	225	297	360

## Cojín sillón Click-Clack

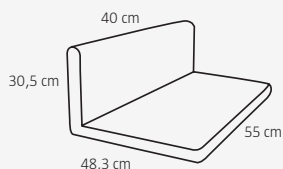

Cojín de algodón y poliéster de 5 cm de grosor en color beige para exterior.

Cotton and polyester cushion 5 cm thickness in beige colour for outdoor use.

Coussin polyester et coton de 5 cm de grosseur de couleur beige pour extérieur.

**W** 74 x **L** 64,5 x **H** 72,5 x **Hs** 42 cm

**W** 29.13 x **L** 25.39 x **H** 28.54 x **Hs** 16.54 in



Negro  
Black  
Noir



Blanco  
White  
Blanc



Arena  
Sand  
Sable



Chocolate  
Chocolate  
Chocolat

**W:** ancho / width / largeur    **L:** largo / length / longueur    **H:** altura / height / hauteur    **Hs:** altura asiento / seat height / hauteur du siège





Barcelona Dd

mesa de centro / coffe table / table basse

# click-clack compact

DESIGNED BY JOSEP LLUSCÀ

Mesa de centro de 92,2x47,2 cm para uso interior y exterior. Estructura inyectada en fibra de vidrio y PP. Tablero de compacto fenólico de 10 mm de grosor. Protección UV. Se entrega desmontada en un óptimo packaging. Peso neto 7,6 kg.

Coffe table 92,2x47,2 cm for indoor and outdoor use. Structure injected in fibreglass with PP. HPL table top of 10 mm thickness. UV protection. Delivered unassembled in an optimal packaging. Net weight 7,6 kg (16.76 lb).

Table basse 92,2x47,2 cm pour usage intérieur et extérieur. Structure injectée en fibre de verre avec PP. Plateau résine phénolique de 10 mm de grosueur. Protection UV. Livrée démontée dans un packaging optimal. Poids net 7,6 kg.

novedad  
new nouveauté



Units STD	Packaging Dimensions (cm)	m3/ pack	NW Unit (kg)	Units Container 20'	Units Container 40'	Units Container HC	Units Trayler (70m3)	Units Truck 100m3
44	120x100x220	2,64	7,6	440	968	968	1.144	-

W 47,2 x L 92,2 x H 40 cm  
W 18.59 x L 36.30 x H 15.75 in

Estructura / Structure / Structure:

Negro Black Noir	Blanco White Blanc	Arena Sand Sable	Chocolate Chocolate Chocolat

Tablero / Table-top / Plateau:

Negro Black Noir	Blanco White Blanc

mesa auxiliar / side table / table auxiliaire

# click-clack compact

DESIGNED BY JOSEP LLUSCÀ

Mesa de centro de 47,2x47,2 cm para uso interior y exterior. Estructura inyectada en fibra de vidrio y PP. Tablero de compacto fenólico de 10 mm de grosor. Protección UV. Se entrega desmontada en un óptimo packaging. Peso neto 4,4 kg.

Coffe table 47,2x47,2 cm for indoor and outdoor use. Structure injected in fibreglass with PP. HPL table top of 10 mm thickness. UV protection. Delivered unassembled in an optimal packaging. Net weight 4,4 kg (7.90 lb).

Table basse 47,2x47,2 cm pour usage intérieur et extérieur. Structure injectée en fibre de verre avec PP. Plateau résine phénolique de 10 mm de grosueur. Protection UV. Livrée démontée dans un packaging optimal. Poids net 4,4 kg.

novedad  
new nouveauté



Units STD	Packaging Dimensions (cm)	m3/ pack	NW Unit (kg)	Units Container 20'	Units Container 40'	Units Container HC	Units Trayler (70m3)	Units Truck 100m3
88	120x100x220	2,64	4,4	880	1.936	1.936	2.288	-

W 47,2 x L 47,2 x H 40 cm  
W 18.59 x L 18.59 x H 15.75 in

Estructura / Structure / Structure:

Negro Black Noir	Blanco White Blanc	Arena Sand Sable	Chocolate Chocolate Chocolat

Tablero / Table-top / Plateau:

Negro Black Noir	Blanco White Blanc

W: ancho / width / largeur L: largo / length / longueur H: altura / height / hauteur

mesa de centro / coffee table / table basse

# click-clack

Mesa de centro de 90x45 cm para uso interior y exterior. Inyectada en fibra de vidrio con PP. Protección contra rayos UV. Peso neto 4,5 kg.

Coffee table 90x45 cm for indoor and outdoor use. Injected in fiberglass with PP. UV Protection. Optional cushions. Net weight 4,5 kg (7.94 lb).

Table basse 90x45 cm d'intérieur et extérieur. Injectée en fibre de verre avec PP. Protection UV. Poids net 4,5 kg.

Units STD	Packaging Dimensions (cm)	m3/ pack	NW Unit (kg)	Units Container 20'	Units Container 40'	Units Container HC	Units Trayler (70m3)	Units Truck 100m3
1	13x92x49	0,059	4,5	580	1.300	-	-	1.600

**W** 90 x **L** 45 x **H** 45 cm

**W** 35.43 x **L** 17.72 x **H** 17.72 in



Negro  
Black  
Noir



Blanco  
White  
Blanc



Arena  
Sand  
Sable



Chocolate  
Chocolate  
Chocolat

Barcelona Dd

mesa auxiliar / side table / table auxiliaire

# click-clack

Mesa auxiliar de 45x45 cm para uso interior y exterior. Inyectada en fibra de vidrio con PP. Protección contra rayos UV. Peso neto 2,8 kg.

Side table 45x45 cm for indoor and outdoor use. Injected in fiberglass with PP. UV Protection. Optional cushions. Net weight 2,8 kg (6.17 lb).

Table auxiliaire 45x45 cm d'intérieur et extérieur. Injectée en fibre de verre avec PP. Protection UV. Poids net 2,8 kg.

Units STD	Packaging Dimensions (cm)	m3/ pack	NW Unit (kg)	Units Container 20'	Units Container 40'	Units Container HC	Units Trayler (70m3)	Units Truck 100m3
1	12x46x48	0,026	2,80	1.140	2.550	-	-	3.300

**W** 45 x **L** 45 x **H** 45 cm

**W** 17.72 x **L** 17.72 x **H** 17.72 in



Negro  
Black  
Noir



Blanco  
White  
Blanc



Arena  
Sand  
Sable



Chocolate  
Chocolate  
Chocolat

**W**: ancho / width / largeur    **L**: largo / length / longueur    **H**: altura / height / hauteur











sofá / sofa / canapé

# bob

DESIGNED BY JOAN GASPAR

Barcelona Dd



Sofá para uso interior y exterior. Asiento de polietileno rotomoldeado. Patas de aluminio pintado. Sistema de evacuación de agua. Protección contra rayos UV. Peso neto 23,50 kg.

Sofa for indoor and outdoor use. Polyethylene rotomoulded seat. Painted aluminium legs. Water drainage system. UV protection. Net weight 23,50 kg. (51.70 lb).

Canapé d'intérieur et extérieur. Siège en polyéthylène rotomoulé. Pieds en aluminium peint. Système d'évacuation d'eau. Protection contre les rayons UV. Poids net 23,50 kg.

Units STD	Packaging Dimensions (cm)	m3/ pack	NW Unit (kg)	Units Container 20'	Units Container 40'	Units Container HC	Units Traylor (70m3)	Units Truck 100m3
1	74x114,50x66	0,56	23,5	50	103	120	125	178

**W** 113 x **L** 72 x **H** 62,5 x **Hs** 37 cm

**W** 44.49 x **L** 28.35 x **H** 24.61 x **Hs** 14.57 in



Negro  
Black  
Noir



Rojo  
Red  
Rouge



Blanco  
White  
Blanc

**W:** ancho / width / largeur **L:** largo / length / longueur **H:** altura / height / hauteur **Hs:** altura asiento / seat height / hauteur du siège

sillón / chair / fauteuil

# bob

DESIGNED BY JOAN GASPAR

Sillón para uso interior y exterior. Asiento de polietileno rotomoldeado. Patas de aluminio pintado. Sistema de evacuación de agua. Protección contra rayos UV. Peso neto 9,24 kg.

Chair for indoor and outdoor use. Polyethylene rotomoulded seat. Painted aluminium legs. Water drainage system. UV protection. Net weight 9,24 kg. (20.32 lb).

Fauteuil d'intérieur et extérieur. Siège en polyéthylène rotomoulé. Pieds en aluminium peint. Système d'évacuation d'eau. Protection contre les rayons UV. Poids net 9,24 kg.

Units STD	Packaging Dimensions (cm)	m3/ pack	NW Unit (kg)	Units Container 20'	Units Container 40'	Units Container HC	Units Trayler (70m3)	Units Truck 100m3
1	55x74x66	0,27	9,24	104	215	256	260	372

**W** 56 x **L** 72 x **H** 62,5 x **Hs** 37 cm

**W** 22.05 x **L** 28.35 x **H** 24.61 x **Hs** 14.57 in



Negro  
Black  
Noir



Rojo  
Red  
Rouge



Blanco  
White  
Blanc

Barcelona Dd

mesa reposapiés / table-footrest / table repose-pied

# bob

DESIGNED BY JOAN GASPAR

Mesa-reposapiés para uso interior y exterior. Sobre de polietileno rotomoldeado. Patas de aluminio pintado. Protección contra rayos UV. Peso neto 6,58 kg.

Table-footrest for indoor and outdoor use. Polyethylene rotomoulded table-footrest top. Painted aluminium legs. UV protection. Net weight 6,58 kg. (14.48 lb).

Table repose-pied d'intérieur et extérieur. Plateau en polyéthylène rotomoulé. Pieds en aluminium peint. Protection contre les rayons UV. Poids net 6,58 kg.

Units STD	Packaging Dimensions (cm)	m3/ pack	NW Unit (kg)	Units Container 20'	Units Container 40'	Units Container HC	Units Trayler (70m3)	Units Truck 100m3
1	58x58x32	0,11	6,58	260	539	640	650	929

**L** 57 x **W** 57 x **H** 33 cm

**L** 22.44 x **W** 22.44 x **H** 12.99 in



Negro  
Black  
Noir



Rojo  
Red  
Rouge



Blanco  
White  
Blanc

**W**: ancho / width / largeur    **L**: largo / length / longueur    **H**: altura / height / hauteur    **Hs**: altura asiento / seat height / hauteur du siège





Barcelona Dd







textil / textile / textile

# seat pad

Barcelona Dd



Cojín de asiento de fieltro de lana de alta calidad con revestimiento de silicona que impide que la almohadilla se deslice en superficies lisas. Seat Pad es un cojín cómodo y práctico que se convierte en un complemento ideal para la mayoría de sillas Barcelona Dd.

Seat cushion made of high quality wool felt with an overleaf silicone coating that prevents the pad from slipping on smooth surfaces. Seat Pad is a comfortable and practical cushion, an ideal complement for the majority of Barcelona Dd chairs.

Coussin de siège en feutre en laine d'haute qualité avec revêtement en silicone au dos qui l'empêche de glisser sur les surfaces lisses. Seat Pad est un confortable et pratique coussin, qui devient un complément idéal pour la majorité des chaises Barcelona Dd.



Antracita  
Anthracite  
Anthracite

textil / textile / textile

# tapizado Barcelona Dd

## Barcelona Dd upholstery revêtement Barcelona Dd

Barcelona Dd

Para evitar marcas, por favor no apile las sillas tapizadas.

In order to avoid marks, please do not stack upholstered chairs.

Pour éviter des marques, ne pas empiler les chaises tapissées.

Tapizado: Tejido en vinílico espumado con soporte textil en poliéster/algodón. Apto para mobiliario de interior y exterior con buena resistencia al desgaste por el roce, impermeable, durable y de fácil limpieza. Se recomienda lavar a mano con detergente neutro. Colores firmes y duraderos. Espumas de espesor 5 mm y presión de 18 kg.

Upholstery: Vinyl fabric with foam and textile backing of polyester/cotton. Suitable for indoor and outdoor furniture with good resistance to friction, waterproof, durable and easy to clean. Recommended to be hand washed with mild detergent. Firm and lasting colours. Foam of 5 mm thick with pressure of 18 kg.

Revêtement: Tissu en vinyle et mousse avec support textile en polyester/coton. Approprié pour les meubles d'intérieur et extérieur avec une bonne résistance à l'abrasion, étanche à l'eau, durable et facile à nettoyer. Il est recommandé de laver à la main avec un détergent neutre. Couleurs solides et durables. Mousse de 5 mm d'épaisseur et pression de 18 kg.

# skin

DESIGNED BY JOSEP LLUSCÀ



Colores tapizado / Upholstered colours / Couleurs revêtement:

				
Chocolate Chocolate Chocolat	Arena Sand Sable	Beige Beige Beige	Rojo Red Rouge	Jean Jean Jean
				
Ocre Ocher Ocre	Naranja Orange Orange	Blanco White Blanc	Negro Black Noir	Nilo Nilo Nilo

Colores silla / Chair colours / Couleurs chaise:

			
Blanco White Blanc	Gris Grey Gris	Chocolate Chocolate Chocolat	Negro Black Noir



textil / textile / textile

# fiona

DESIGNED BY JOSEP LLUSCÀ

Barcelona Dd



Colores tapizado / Upholstered colours / Couleurs revêtement:



Chocolate  
Chocolate  
Chocolat  
Arena  
Sand  
Sable  
Beige  
Beige  
Beige  
Rojo  
Red  
Rouge  
Jean  
Jean  
Jean



Ocre  
Ocher  
Ocre  
Naranja  
Orange  
Orange  
Blanco  
White  
Blanc  
Negro  
Black  
Noir  
Nilo  
Nilo  
Nilo

Colores silla / Chair colours / Couleurs chaise:



Blanco  
White  
Blanc  
Verde oliva  
Olive green  
Vert olive  
Chocolate  
Chocolate  
Chocolat  
Negro  
Black  
Noir  
Arena  
Sand  
Sable



Gris oscuro  
Dark grey  
Gris foncé

# peach

DESIGNED BY JOAN GASPAR



Colores tapizado / Upholstered colours / Couleurs revêtement:



Chocolate  
Chocolate  
Chocolat  
Arena  
Sand  
Sable  
Beige  
Beige  
Beige  
Rojo  
Red  
Rouge  
Jean  
Jean  
Jean



Ocre  
Ocher  
Ocre  
Naranja  
Orange  
Orange  
Blanco  
White  
Blanc  
Negro  
Black  
Noir  
Nilo  
Nilo  
Nilo

Colores silla / Chair colours / Couleurs chaise:



Blanco  
White  
Blanc  
Rojo  
Red  
Rouge  
Chocolate  
Chocolate  
Chocolat  
Negro  
Black  
Noir  
Arena  
Sand  
Sable



Verde oliva  
Olive green  
Vert olive

textil / textile / textile

# lisboa

DESIGNED BY JOAN GASPAR



Colores tapizado / Upholstered colours / Couleurs revêtement:

Chocolate Chocolate Chocolat	Arena Sand Sable	Beige Beige Beige	Rojo Red Rouge	Jean Jean Jean
Ocre Ocher Ocre	Naranja Orange Orange	Blanco White Blanc	Negro Black Noir	Nilo Nilo Nilo

Colores silla / Chair colours / Couleurs chaise:

Blanco White Blanc	Rojo Red Rouge	Verde oliva Olive green Vert olive	Chocolate Chocolate Chocolat	Negro Black Noir
Arena Sand Sable	Gris oscuro Dark grey Gris foncé	Toscano (Silla sin brazos) Tuscan (Armless chair) Toscan (Chaise sans bras)		

Barcelona Dd

# neutra

DESIGNED BY JOAN GASPAR



Colores tapizado / Upholstered colours / Couleurs revêtement:

Chocolate Chocolate Chocolat	Arena Sand Sable	Beige Beige Beige	Rojo Red Rouge	Jean Jean Jean
Ocre Ocher Ocre	Naranja Orange Orange	Blanco White Blanc	Negro Black Noir	Nilo Nilo Nilo

Colores silla / Chair colours / Couleurs chaise:

Blanco White Blanc	Rojo Red Rouge	Chocolate Chocolate Chocolat	Negro Black Noir	Arena Sand Sable
Verde oliva Olive green Vert olive				



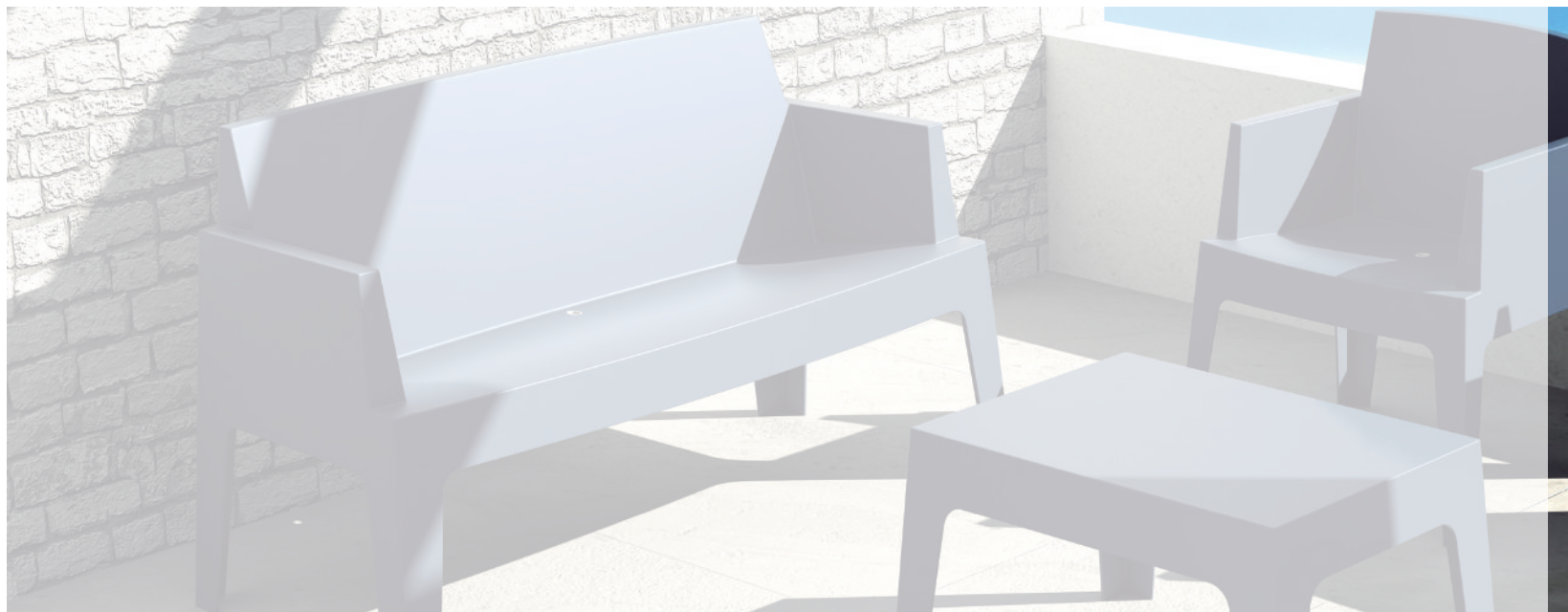

RESOL BASIC ofrece una colección de sillas , mesas y taburetes diseñados y fabricados con distintos materiales y colores singulares que aportan luminosidad e interesantes juegos cromáticos a cualquier espacio ya sea público o doméstico.

RESOL BASIC offers a collection of chairs, tables, and stools designed and manufactured in different materials and unique colours creating interesting chromatic and luminous combinations in any space, be it commercial or residential.

RESOL BASIC offre une collection de chaises, tables et tabourets conçus et fabriqués en différents matériaux et dans des couleurs singulières créant de la luminosité et d'intéressants jeux chromatiques à tout espace, soit commercial ou résidentiel.

resol



resol  
basic

**Sillas**  
**Chairs**  
**Chaises**

Visual.....	136
Fiesta.....	136
Uma.....	136
Vítrea.....	138
Cosmo.....	138
Frappé.....	138
Mia.....	140
Dionisio.....	140
Coral.....	140
Alma.....	142
Alma con brazos.....	142
Alma sillón bajo.....	142
Grid.....	144
Urban sillón.....	147
Urban sofá.....	147

**Mesas**  
**Tables**  
**Tables**

Safri.....	144
Arctic.....	144
Urban.....	147

**Tumbona**  
**Sunlonger**  
**Chaise longue**

Capri.....	150
------------	-----

**Taburetes**  
**Stools**  
**Tabourets**

Rick.....	145
Darren.....	145
Grid.....	146



silla / chair / chaise

## Visual



CATAS®

Silla apilable para uso interior y exterior de policarbonato. Tratamiento antiarañazos y protección rayos UV. Peso neto 3,7 kg.

Stackable chair for indoor and outdoor use, in polycarbonate. Scratch resistant. UV protection. Net weight 3,7 kg (8.16 lb).

Chaise empilable pour usage intérieur et extérieur, en polycarbonate. Antirayure et UV protection. Poids net 3,7 kg.

Units STD	Packaging Dimensions (cm)	m3/ pack	NW Unit (kg)	Units Container 20'	Units Container 40'	Units Container HC	Units Trayler (70m3)	Units Truck 100m3
4	104x47x69	0,34	3,70	320	816	912	-	-



W 46 x L 87 x H 53,7 x Hs 46 cm

W 18.11 x L 34.25 x H 21.14 x Hs 18.11 in



Transparente  
Transparent  
Transparent



Blanco  
White  
Blanc



Negro  
Black  
Noir

RESOL Basic

silla / chair / chaise

## Fiesta



CATAS®

Silla apilable para uso interior y exterior, inyectada en polipropileno con fibra de vidrio mediante tecnología "Air Moulding Process". Protección UV. Peso neto 3,25 kg.

Stackable chair for indoor and outdoor use, injected in polypropylene with fiberglass with the "Air Moulding Process". UV protection. Net weight 3,25 kg (7.17 lb).

Chaise empilable pour usage intérieur et extérieur, injectée en polypropylène avec fibre de verre avec la technologie "Air Moulding Process". Protection UV. Poids net 3,25 kg.

Units STD	Packaging Dimensions (cm)	m3/ pack	NW Unit (kg)	Units Container 20'	Units Container 40'	Units Container HC	Units Trayler (70m3)	Units Truck 100m3
4	230x46x95	1	3,25	720	1.560	1.680	-	-



W 45 x L 85 x H 51 x Hs 46 cm

W 17.72 x L 33.46 x H 20.08 x Hs 18.11 in



Blanco  
White  
Blanc



Marrón  
Brown  
Brun

silla / chair / chaise

## Uma



CATAS®

Silla apilable para uso interior y exterior. Inyectada en policarbonato. Protección U.V.

Stackable chair for indoor and outdoor use. Injected in polycarbonate. U.V. protection.

Chaise empilable pour intérieur et extérieur. Injectée en polycarbonate. Protection U.V.

Units STD	Packaging Dimensions (cm)	m3/ pack	NW Unit (kg)	Units Container 20'	Units Container 40'	Units Container HC	Units Trayler (70m3)	Units Truck 100m3
4	45x68x96	0.290	4,80	340	680	760	820	1.172



W 42 x L 53 x H 84 cm

W 16.54 x L 20.87 x H 33.07 in



Transparente  
Transparent  
Transparent



Negro transparente  
Transparent black  
Noir transparent





silla / chair / chaise

## Vítrea



Silla apilable para uso interior. Policarbonato reciclable y patas tubulares de acero cromado.

Stackable chair for indoor use. Recyclable polycarbonate main body. Legs frame in tubular chrome steel.

Chaise empilable pur usage intérieur. Polycarbonate recyclable et pieds chromés en acier tubulaire.

Units STD	Packaging Dimensions (cm)	m3/ pack	NW Unit (kg)	Units Container 20'	Units Container 40'	Units Container HC	Units Trayler (70m3)	Units Truck 100m3
4	99x52x70	0,36	5,50	264	552	552	760	880



**W** 56 x **L** 54 x **H** 84 cm  
**W** 22.05 x **L** 21.26 x **H** 33.07 in



Transparente  
 Transparent  
 Transparent

RESOL Basic

sillón / armchair / fauteuil

## Cosmo



Sillón apilable para uso interior y exterior. Inyectada en policarbonato. Protección UV. Aditivos antiarañazos.

Stackable armchair for indoor and outdoor use. Injected in polycarbonate. UV protection. Antiscratch.

Fauteuil empilable pour usage intérieur et extérieur. En polycarbonate injecté. Protection contre les UV. Anti-rayure.

Units STD	Packaging Dimensions (cm)	m3/ pack	NW Unit (kg)	Units Container 20'	Units Container 40'	Units Container HC	Units Trayler (70m3)	Units Truck 100m3
4	113x57x78	0,502	5	240	480	680		



**W** 56 x **L** 60 x **H** 91 x **Hs** 46 x **Ha** 66,5 cm  
**W** 22.05 x **L** 23.62 x **H** 35.83 x **Hs** 18.11 x **Ha** 26.18 in



Transparente  
 Transparent  
 Transparent

**CATAS**

Seat static loading test according to EN 15373 LEVEL 2 - 2011

silla / chair / chaise

## Frappé



Silla apilable para uso interior y exterior. Inyectada con la tecnología "Air Moulding Process". Asiento en polipropileno reforzado con fibra de vidrio, respaldo en policarbonato transparente.

Stackable chair for indoor and outdoor use. Injected with the "Air Moulding Process" technology. Seat in polypropylene reinforced with fiberglass, polycarbonate backing.

Chaise empilable pour usage intérieur et extérieur. Injectée avec la technologie "Air Process Moulding". Assise en polypropylène renforcé de fibre de verre, la dossier en polycarbonate.

Units STD	Packaging Dimensions (cm)	m3/ pack	NW Unit (kg)	Units Container 20'	Units Container 40'	Units Container HC	Units Trayler (70m3)	Units Truck 100m3
4	102x48x70	0,343	3,95	288	712	712	912	1.056



**W** 42 x **L** 51 x **H** 85 cm  
**W** 16.54 x **L** 20.08 x **H** 33.46 in



Blanco  
 White  
 Blanc



Negro  
 Black  
 Noir

**CATAS**





silla / chair / chaise

## Mia



CATAS®

Silla apilable para uso interior y exterior. Inyectada en poliamida o policarbonato, protección U.V. Aditivos antiarañazos e ignífugos para el modelo de poliamida.

Stackable chair for indoor and outdoor use. Injected in polyamide or polycarbonate, U.V. protection. Antiscratch and fire retardant for polyamide's model.

Chaise empilable pour intérieur et extérieur. Injectée en polyamide ou polycarbonate, protection U.V. traitement anti rayures et anti feu pour la chaise en polyamide.

Units STD	Packaging Dimensions (cm)	m3/ pack	NW Unit (kg)	Units Container 20'	Units Container 40'	Units Container HC	Units Trayler (70m3)	Units Truck 100m3
4	48x69x109	0.360	4,1	320	656	792	936	1.056



W 47 x L 50 x H 90 cm

W 18.50 x L 19.68 x H 35.43 in



Transparente

Transparent

Transparent



Blanco

White

Blanc



Negro

Black

Noir

sillón / armchair / fauteuil

## Dionisio



CATAS®

Sillón apilable de polipropileno con fibra de vidrio para uso interior y exterior. Inyectada con la tecnología "Air Moulding Process". Protección U.V.

Stackable fiberglass polypropylene armchair for indoor and outdoor use. Injected with the "Air Moulding Process" technology. U.V. protection.

Fauteuil empilable en polypropylène avec fibre de verre pour usage intérieur et extérieur. Injectée avec la technologie "Air moulding process". Protection U.V.

Units STD	Packaging Dimensions (cm)	m3/ pack	NW Unit (kg)	Units Container 20'	Units Container 40'	Units Container HC	Units Trayler (70m3)	Units Truck 100m3
22	58x95x227	1.240	3,95	528	1144	1.188	1.232	1.408



W 57 x L 52 x H 85 x Hs 45 x Ha 64 cm

W 22.44 x L 20.47 x H 33.46 x Hs 17.71 x Ha 25.19 in



Blanco

White

Blanc



Negro

Black

Noir

silla / chair / chaise

## Coral



CATAS®

Silla apilable para uso interior y exterior. Inyectada en policarbonato, protección U.V.

Stackable chair for indoor and outdoor use. Injected in polycarbonate, U.V. protection.

Chaise empilable pour intérieur et extérieur. Injectée en polycarbonate, protection U.V.

Units STD	Packaging Dimensions (cm)	m3/ pack	NW Unit (kg)	Units Container 20'	Units Container 40'	Units Container HC	Units Trayler (70m3)	Units Truck 100m3
4	59x79x92	0,430	5	216	440	592	720	912



W 59 x L 60 x H 80 cm

W 23.22 x L 23.62 x H 31.49 in



Blanco

White

Blanc



Transparente

Transparent

Transparent

Seat static loading test according to EN 15373 LEVEL 2 - 2010



RESOL Basic



silla / chair / chaise

## Alma



CATAS®

Silla inyectada en fibra de vidrio y PP mediante tecnología de moldeo asistida por gas. Apilable. Para uso interior y exterior. Protección UV.

Chair injected with fibreglass and PP using gas assisted injection technology. Stackable. For indoor and outdoor use. UV Protection.

Chaise injectée avec fibre de verre et PP, en utilisant technologie de moulage assistée par gaz. Empilable. Protection UV.

Units STD	Packaging Dimensions (cm)	m3/ pack	NW Unit (kg)	Units Container 20'	Units Container 40'	Units Container HC	Units Traylor (70m3)	Units Truck 100m3
24	48x230x95	1,070	4,5	576	1.200	-	1.344	-



W 48 x L 58 x H 82 cm

W 18.89 x L 22.83 x H 32.48 in



Blanco

White

Blanc



Negro

Black

Noir

RESOL Basic

Silla con brazos / armchair / fauteuil

## Alma



CATAS®

Silla con brazos inyectada en fibra de vidrio y PP mediante tecnología de moldeo asistida por gas. Apilable. Para uso interior y exterior. Protección UV.

Armchair injected with fibreglass and PP using gas assisted injection technology. Stackable. For indoor and outdoor use. UV Protection.

Fauteuil injecté avec fibre de verre et PP, en utilisant technologie de moulage assistée par gaz. Empilable. Protection UV.

Units STD	Packaging Dimensions (cm)	m3/ pack	NW Unit (kg)	Units Container 20'	Units Container 40'	Units Container HC	Units Traylor (70m3)	Units Truck 100m3
22	58x230x95	1,267	5	528	1.100	-	1.232	-



W 58 x L 58 x H 82 cm

W 22.83 x L 22.83 x H 32.48 in



Blanco

White

Blanc



Negro

Black

Noir

sillón bajo / low armchair / fauteuil bas

## Alma



novedad  
new nouveauté

CATAS®

Sillón bajo apilable para uso interior y exterior inyectado en polipropileno y fibra de vidrio. Incluye cojín de poliéster.

Stackable low armchair for indoor and outdoor use, injected with fiberglass and PP. Polyester cushion included.

Fauteuil bas empilable pour usage intérieur et extérieur, injecté avec fibre de verre et PP. Coussin polyester inclus.

Units STD	Packaging Dimensions (cm)	m3/ pack	NW Unit (kg)	Units Container 20'	Units Container 40'	Units Container HC	Units Traylor (70m3)	Units Truck 100m3
12	73x252x104	1,913	10	170	396	-	-	468



W 71 x L 89 x H 76 x Hs 38 cm

W 27.95 x L 35.04 x H 29.92 x H 14.96 in



Blanco

White

Blanc



Negro

Black

Noir





RESOL Basic





silla / chair / chaise

## Grid



CATAS®

Silla inyectada en fibra de vidrio y PP mediante tecnología de moldeo asistida por gas. Apilable. Para uso interior y exterior. Protección UV.

Chair injected with fibreglass and PP using gas assisted injection technology. Stackable. For indoor and outdoor use. UV Protection.

Chaise injectée avec fibre de verre et PP, en utilisant technologie de moulage assistée par gaz. Empilable. Protection UV.

Units STD	Packaging Dimensions (cm)	m3/ pack	NW Unit (kg)	Units Container 20'	Units Container 40'	Units Container HC	Units Traylor (70m3)	Units Truck 100m3
4	52x90x77	0,360	3,5	320	736	-	936	-



W 50 x L 82 x H 60 cm

W 19.68 x L 32.48 x H 23.62 in



Blanco

White

Blanc



Negro

Black

Noir



Rojo

Red

Rouge

RESOL Basic

mesa / table / table

## Safri



Mesa redonda plegable de aluminio para uso interior y exterior. Peso neto 7,30 kg. Nivelador en una pata

Foldable round aluminium table for indoor and outdoor use. Net weight 7,30 kg (16.09 lb). Leveller in one leg.

Table ronde pliante en aluminium pour intérieur et extérieur. Poids net 7,30 kg. Niveleur sur un pied.

Units STD	Packaging Dimensions (cm)	m3/ pack	NW Unit (kg)	Units Container 20'	Units Container 40'	Units Container HC	Units Traylor (70m3)	Units Truck 100m3
1	83x83x12	0,08	7,30	355	714	805	-	-



Negro

Black

Noir

Ø 80 x H 74 cm

W 31.50 x H 29.13 in

mesa / table / table

## Arctic



Mesa para uso interior y exterior fabricada en resina muy resistente y duradera. Protección UV. Desmontable. Disponible en 2 medidas: 80x80, peso neto 10 kg, y 140x80, peso neto 15 kg.

Table for indoor and outdoor use, made of very strong and durable resin. UV Protection. It can be dismantled. Available in 2 sizes: 80x80, net weight 10 kg, and 140x80, net weight 15 kg (33,07 lb).

Table pour usage intérieur et extérieur, fabriquée en résine très résistante et durable. Protection UV. Démontable. Disponible dans 2 mesures: 80x80, poids net 10 kg, et 140x80, poids net 15 kg.

Units STD	Packaging Dimensions (cm)	m3/ pack	NW Unit (kg)	Units Container 20'	Units Container 40'	Units Container HC	Units Traylor (70m3)	Units Truck 100m3
1	81x81x15	0,098	-	266	660	-	-	800
1	141x80x15	0,171	-	165	374	-	-	500

L 80 x W 80 x H 75 cm

L 31.50 x W 31.50 x H 29.53 in

L 140 x W 80 x H 75 cm

L 55.12 x W 31.50 x H 29.53 in



Blanco

White

Blanc



Negro

Black

Noir

taburete / stool / tabouret

## Darren



CATAS®

Taburete apilable para uso interior y exterior. Inyectado en policarbonato y con protección U.V.  
Stackable stool for indoor and outdoor use. Injected in polycarbonate with U.V. protection.  
Tabouret empilable pour intérieur et extérieur. Injecté en polycarbonate et protection U.V.

Units STD	Packaging Dimensions (cm)	m3/ pack	NW Unit (kg)	Units Container 20'	Units Container 40'	Units Container HC	Units Traylor (70m3)	Units Truck 100m3
2	39x39x115	0,180	3,05	360	720	754	776	1.120



Transparente  
Transparent  
Transparent

W 27 x L 27 x H 75 cm

W 10.63 x L 10.63 x H 29.5 3 in

taburete / stool / tabouret

## Rick



Taburete apilable para uso interior y exterior. Estructura de aluminio anodizado de 25 x 25 mm y 2 mm de grosor. Asiento y respaldo de polipropileno. Uniones de poliamida y fibra de vidrio. Con sistema de evacuación de agua, protección UV y tacos antideslizantes.

Stackable stool for indoor and outdoor use. Anodized aluminium structure of 25 x 25 mm and 2 mm thickness. Seat and back of polypropylene. Polyamide and fiberglass joints. Water drainage system, with UV protection and non-slip pads.

Tabouret empilable pour usage intérieur ou extérieur. Structure en aluminium anodisé 25 x 25 mm et 2 mm de grosseur. Siège et dossier en polypropylène. Raccords en polyamide et fibre de verre. Système d'évacuation d'eau. Protection U.V. et basses antidérapantes.

Units STD	Packaging Dimensions (cm)	m3/ pack	NW Unit (kg)	Units Container 20'	Units Container 40'	Units Container HC	Units Traylor (70m3)	Units Truck 100m3
4	49x62x117	0,350	3,75	288	608	760	880	1.000



Blanco  
White  
Blanc



Beige  
Beige  
Beige



Naranja  
Orange  
Orange



Negro  
Black  
Noir

W 46 x L 46 x H 96 (75) cm

W 18.11 x L 18.11 x H 37.79 (29.53) in

W: ancho / width / largeur L: largo / length / longueur H: altura / height / hauteur Hs: altura asiento / seat height / hauteur du siège Ha: altura brazo / armrest height / hauteur de l'accoudoir





taburete / stool / tabouret

# Grid

**novedad**  
new nouveauté



**CATAS**

Taburete para uso interior y exterior, inyectado en polipropileno y fibra de vidrio mediante tecnología de moldeo asistida por gas. Protección UV.

Stool for indoor and outdoor use, injected with fiberglass and PP using gas assisted injection moulding technology. Table auxiliare empilable en polypropylène pour usage intérieur ou extérieur. Protection U.V.

Tabouret d'intérieur et extérieur, injectée avec fibre de verre et PP, en utilisant technologie de moulage assistée par gaz. Protection UV.

Units STD	Packaging Dimensions (cm)	m3/ pack	NW Unit (kg)	Units Container 20'	Units Container 40'	Units Container HC	Units Traylor (70m3)	Units Truck 100m3
4	47x118x70	0,388	5	320	680	-	-	912
4	47x108x70	0,355	4,5	320	816	-	-	912

**L** 45 x **W** 105 x **H** 53 x **Hs** 75 cm

**L** 17.72 x **W** 41.34 x **H** 20.87 x **Hs** 29.53 in

**L** 44 x **W** 95 x **H** 51 x **Hs** 65 cm

**L** 17.32 x **W** 37.40 x **H** 20.08 x **Hs** 25.59 in



Blanco

White

Blanc



Rojo

Red

Rouge

**W:** ancho / width / largeur **L:** largo / length / longueur **H:** altura / height / hauteur **Hs:** altura asiento / seat height / hauteur du siège **Ha:** altura brazo / armrest height / hauteur de l'accoudoir



sillón / armchair / fauteuil

## Urban



**CATAS**

Seat static loading test according to EN 15373 LEVEL 2 - 2010

Sillón apilable de polipropileno. Resistente y estable. Para uso interior y exterior. 7 kg. Sistema de evacuación de agua. Protección U.V.

Stackable armchair of polypropylene. Strong and stable. For outdoor and indoor use. 15.43 lb. Water drainage system. U.V. protection.

Fauteuil empilable en polypropylène. Fort et stable. Pour usage intérieur et extérieur. 7 kg. Système d'évacuation d'eau. Protection U.V.

Units STD	Packaging Dimensions (cm)	m3/ pack	NW Unit (kg)	Units Container 20'	Units Container 40'	Units Container HC	Units Traylor (70m3)	Units Truck 100m3
4	114x66x58	0,436	7	256	576	576	640	960



Blanco  
White  
Blanc



Negro  
Black  
Noir



Gris  
Grey  
Gris

**W** 65 x **L** 58 x **H** 80 x **Hs** 44 x **Ha** 64 cm

**W** 25.59 x **L** 22.83 x **H** 31.50 x **Hs** 17.32 x **Ha** 25.19 in

sofá / sofa / sofa

## Urban



**CATAS**

Seat static loading test according to EN 15373 LEVEL 2 - 2010

Sofá apilable de polipropileno, para uso interior y exterior. Sistema de evacuación de agua. Protección U.V.

Stacking sofa in polypropylene, for indoor and outdoor use. Water drainage system. U.V. protection.

Sofa empilable en polypropylène pour usage intérieur ou extérieur. Système d'évacuation d'eau Protection U.V.

Units STD	Packaging Dimensions (cm)	m3/ pack	NW Unit (kg)	Units Container 20'	Units Container 40'	Units Container HC	Units Traylor (70m3)	Units Truck 100m3
12	215x139x63	1.882	14	156	324	360	-	-



Blanco  
White  
Blanc



Negro  
Black  
Noir



Gris  
Grey  
Gris

**W** 138 x **L** 80 x **H** 62 cm x **Hs** 44 x **Ha** 54 cm

**W** 54.33 x **L** 31.49 x **H** 24.40 x **Hs** 17.32 x **Ha** 21.26 in

mesa / table / table

## Urban



Mesa auxiliar apilable de polipropileno, para uso interior y exterior. Protección U.V.

Auxiliary stacking table in polypropylene, for indoor and outdoor use. U.V. protection.

Table auxiliaire empilable en polypropylène pour usage intérieur ou extérieur. Protection U.V.

Units STD	Packaging Dimensions (cm)	m3/ pack	NW Unit (kg)	Units Container 20'	Units Container 40'	Units Container HC	Units Traylor (70m3)	Units Truck 100m3
4	66x77x57	0,29	4	360	1.008	1.104	-	-



Blanco  
White  
Blanc



Negro  
Black  
Noir



Gris  
Grey  
Gris

**L** 70 x **W** 43 x **H** 50 cm

**L** 27.55 x **W** 16.92 x **H** 19.68 in









RESOL Basic



tumbona / sunlounger / chaise longue

# Capri

**novedad**  
new nouveauté



Tumbona con estructura en resina reforzada con fibra de vidrio y textilene transpirable (reemplazable). Apilable, reclinable en 5 posiciones, con tacos antideslizantes y ruedas pequeñas.

Sunlounger with tubular frame in resin reinforced with glass fiber and cover in breathable synthetic fabric (replaceable). Stackable, back reclining in 5 positions, with non-slip feet and small wheels.

Chaise longue avec structure en résine et fibre de verre renforcée et respirant textilène (remplaçable). Empilable et 5 positions du dossier. Pieds antidérapants et petites roues.

Units STD	Packaging Dimensions (cm)	m3/ pack	NW Unit (kg)	Units Container 20'	Units Container 40'	Units Container HC	Units Trayler (70m3)	Units Truck 100m3
18	254x70x194	3,449	16,5	144	324	324	-	420

estructura trame structure	textilene textilene textilène	
Blanco White Blanc	Beige Beige Beige	Azul Blue Bleu
Gris Grey Gris	Negro Black Noir	

**W** 68 x **L** 193 x **H** 26 cm  
**W** 26.77 x **L** 75.98 x **H** 13.78 in



**W:** ancho / width / largeur    **L:** largo / length / longueur    **H:** altura / height / hauteur    **Hs:** altura asiento / seat height / hauteur du siège    **Ha:** altura brazo / armrest height / hauteur de l'accoudoir







RESOL Basic



RESOL ratán inyectado es una línea de mobiliario de alta calidad que imita con gran certeza el entramado del mimbre natural. Está fabricada en polipropileno reforzado con fibra de vidrio y protección UV, asegurando de este modo el mantenimiento del color y una gran resistencia a la intemperie y a la manipulación. Los materiales de fabricación son 100% reciclables. Las mesas están diseñadas para un rápido y fácil montaje sin la necesidad de usar herramientas.

RESOL ratán inyectado es una colección exclusiva de gran belleza que inspira calidez y comodidad.

RESOL injected rattan is a line of high-quality furniture that effectively imitates the texture of natural wicker. It is manufactured with polypropylene reinforced with fiberglass and UV protection, ensuring the colours from fading and greatly improving the resistance to rough weather and handling. Materials are 100% recyclable. Tables are designed for a fast and easy installation, without the need to use tools.

RESOL injected rattan is an exclusive and beautiful collection which inspires warmth and comfort.

RESOL rattan injecté est une ligne de meubles d'haute qualité qui imitent effectivement la texture de la fibre naturelle. Est fabriquée en polypropylène renforcé avec fibre de verre et protection UV, en assurant de cette façon la conservation de la couleur et une grande résistance au mauvais temps et à la manipulation. Les matériaux sont 100% recyclables. Les tables sont conçues de telle sorte qu'elles permettent un montage facile et rapide, sans avoir à utiliser des outils.

RESOL rattan injecté est une collection exclusive et belle qui inspire chaleur et confort.

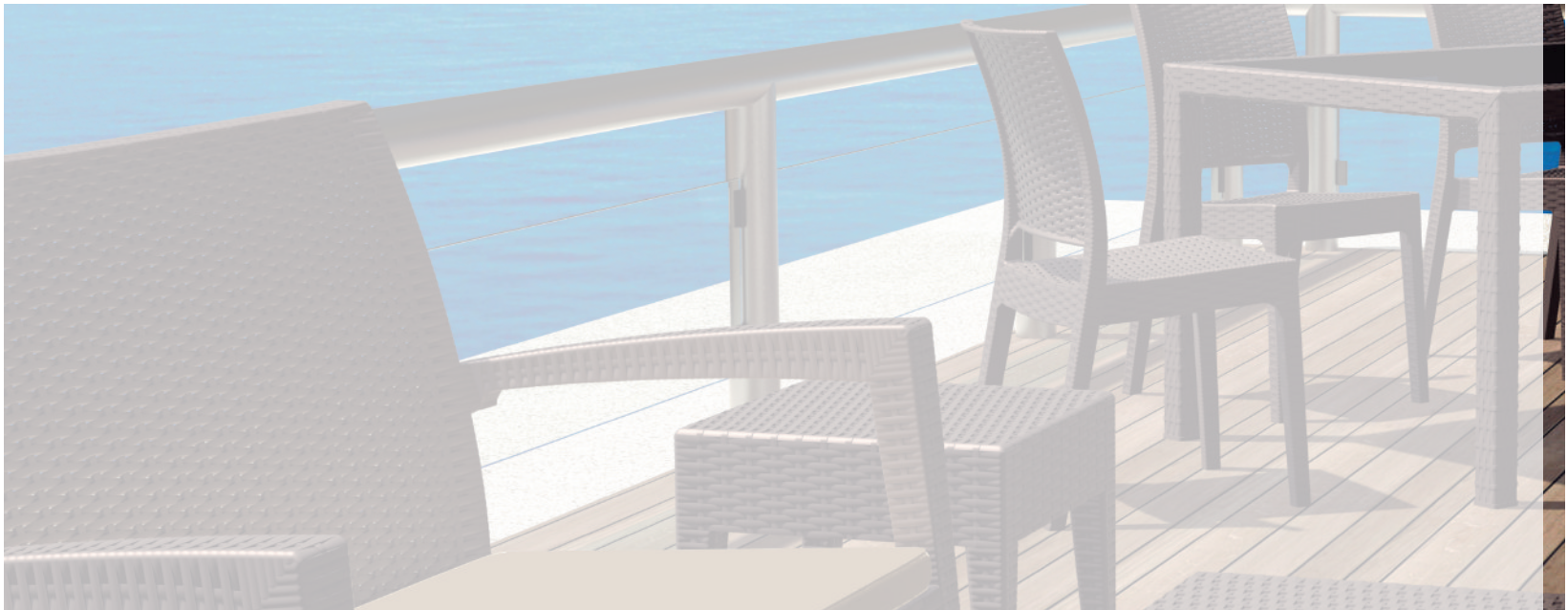

resol

**Sillas**  
**Chairs**  
**Chaises**

---

Indiana .....	154
Indiana sillón .....	154
Indiana taburete .....	154
Modena .....	156
Modena sillón .....	156
Ipanema sillón .....	160
Ipanema sofá .....	160
Estoril sillón .....	162
Algarve sillón .....	162

**Mesas**  
**Tables**  
**Tables**

---

Indian .....	156
Atlantic .....	157
Pacific .....	157
Ipanema mesa de centro .....	161
Ipanema mesa auxiliar .....	161

**Tumbonas**  
**Sunloungers**  
**Chaises longues**

---

Tropic .....	158
--------------	-----

**Set**

---

Set Ipanema .....	159
-------------------	-----



**resol**  
ratán inyectado



silla / chair / chaise

## Indiana



**CATAS**

Seat static loading test according to EN 15373 LEVEL 2 - 2011

Silla apilable para uso interior y exterior fabricada en resina muy resistente y duradera reforzada con fibra de vidrio. Protección UV.

Stackable chair for indoor and outdoor use made of very strong and durable resin reinforced with fiberglass. UV protection.

Chaise empilable pour une utilisation intérieure et extérieure fabriquée en résine très solide et durable renforcée avec fibre de verre. Protection UV.

Units STD	Packaging Dimensions (cm)	m3/ pack	NW Unit (kg)	Units Container 20'	Units Container 40'	Units Container HC	Units Trayler (70m3)	Units Truck 100m3
16	95x47x220	0,982	4	480	992	1.260	-	-



**W** 45 x **L** 52 x **H** 87 x **Hs** 45 cm

**W** 17.72 x **L** 20.47 x **H** 34.25 x **Hs** 17.72 in



Chocolate

Chocolate

Chocolat



Blanco

White

Blanc

sillón / armchair / fauteuil

## Indiana



**CATAS**

Seat static loading test according to EN 15373 LEVEL 2 - 2011

Sillón apilable para uso interior y exterior fabricada en resina muy resistente y duradera reforzada con fibra de vidrio. Protección UV.

Stackable armchair for indoor and outdoor use made of very strong and durable resin reinforced with fiberglass. UV protection.

Fauteuil empilable pour une utilisation intérieure et extérieure fabriqué en résine très solide et durable renforcée avec fibre de verre. Protection UV.

Units STD	Packaging Dimensions (cm)	m3/ pack	NW Unit (kg)	Units Container 20'	Units Container 40'	Units Container HC	Units Trayler (70m3)	Units Truck 100m3
16	58x98x228	1,295	4,5	384	768	768	1.008	-



**W** 58 x **L** 59 x **H** 87 x **Hs** 46 x **Ha** 65 cm

**W** 22.83 x **L** 23.23 x **H** 34.25 x **Hs** 18.110 x **Ha** 25.59 in



Chocolate

Chocolate

Chocolat



Blanco

White

Blanc

taburete / stool / tabouret

## Indiana



**CATAS**

Seat static loading test according to EN 15373 LEVEL 2 - 2011

Taburete para uso interior y exterior fabricado en resina muy resistente y reforzado con fibra de vidrio. Protección UV. Apilable. Peso neto 5 kg.

Stool for indoor and outdoor use, made of very strong resin reinforced with fiberglass. UV Protection. Stackable. Net weight 5 kg (11,02 lb).

Tabouret pour une utilisation intérieure et extérieure, fabriqué en résine très résistante renforcée avec fibre de verre. Protection UV. Empilable. Poids net 5 kg.

Units STD	Packaging Dimensions (cm)	m3/ pack	NW Unit (kg)	Units Container 20'	Units Container 40'	Units Container HC	Units Trayler (70m3)	Units Truck 100m3
4	133x43x64	0,366	5	288	732	840	-	-



**W** 40 x **L** 51 x **H** 108 x **Hs** 75 cm

**W** 15.75 x **L** 20.08 x **H** 42.52 **Hs** 29.53 in



Chocolate

Chocolate

Chocolat



RESOL Rattan inyectado



silla / chair / chaise

## Modena



**CATAS**

Seat static loading test according to EN 15373 LEVEL 2 - 2011

Silla apilable para uso interior y exterior fabricada en resina muy resistente y duradera reforzada con fibra de vidrio. Protección UV.

Stackable chair for indoor and outdoor use made of very strong and durable resin reinforced with fiberglass. UV protection.

Chaise empilable pour une utilisation intérieure et extérieure fabriquée en résine très solide et durable renforcée avec fibre de verre. Protection UV.

Units STD	Packaging Dimensions (cm)	m3/ pack	NW Unit (kg)	Units Container 20'	Units Container 40'	Units Container HC	Units Trayler (70m3)	Units Truck 100m3
22	102x58x232	1,254	3,60	484	1.012	1.012	1.146	-



**W** 47 x **L** 62 x **H** 82 x **Hs** 45 cm

**W** 18.50 x **L** 24.41 x **H** 32.28 x **Hs** 17.72 in



Chocolate

Chocolate

Chocolat

sillón / armchair / fauteuil

## Modena



**CATAS**

Seat static loading test according to EN 15373 LEVEL 2 - 2011

Sillón apilable para uso interior y exterior fabricada en resina muy resistente y duradera reforzada con fibra de vidrio. Protección UV.

Stackable armchair for indoor and outdoor use made of very strong and durable resin reinforced with fiberglass. UV protection.

Fauteuil empilable pour une utilisation intérieure et extérieure fabriqué en résine très solide et durable renforcée avec fibre de verre. Protection UV.

Units STD	Packaging Dimensions (cm)	m3/ pack	NW Unit (kg)	Units Container 20'	Units Container 40'	Units Container HC	Units Trayler (70m3)	Units Truck 100m3
22	102x58x232	1,372	4	484	1.012	1.012	1.144	-



**W** 58 x **L** 62 x **H** 82 x **Hs** 45 x **Ha** 65,5 cm

**W** 22.83 x **L** 24.41 x **H** 32.28 x **Hs** 17.72 x **Ha** 25.78 in



Chocolate

Chocolate

Chocolat

RESOL Rattan inyectado

mesa / table / table

## Indian



Mesa para uso interior y exterior fabricada en resina muy resistente y duradera. Protección UV. Desmontable. Disponible en 2 medidas: 80x80 cm, peso neto 10 kg, y 140x80 cm, peso neto 15 kg.

Table for indoor and outdoor use, made of very strong and durable resin. UV Protection. It can be dismantled. Available in 2 sizes: 80x80 cm, net weight 10 kg (22.05 lb), and 140x80 cm, net weight 15 kg (33.07 lb).

Table pour usage intérieur et extérieur, fabriquée en résine très résistante et durable. Protection UV. Démontable. Disponible dans 2 mesures: 80x80 cm, poids net 10 kg, et 140x80 cm, poids net 15 kg.

Units STD	Packaging Dimensions (cm)	m3/ pack	NW Unit (kg)	Units Container 20'	Units Container 40'	Units Container HC	Units Trayler (70m3)	Units Truck 100m3
1	81x81x15	0,098	10	266	660	-	800	-
1	141x80x15	0,171	15	165	374	-	500	-

**L** 80 x **W** 80 x **H** 75 cm

**L** 31.50 x **W** 31.50 x **H** 29.53 in

**L** 140 x **W** 80 x **H** 75 cm

**L** 55.12 x **W** 31.50 x **H** 29.53 in



Chocolate

Chocolate

Chocolat

mesa / table / table

## Atlantic



Mesa cuadrada para uso interior y exterior fabricada en resina muy resistente y duradera reforzada con fibra de vidrio. Protección UV. Sobre de cristal templado oscuro de 5 mm de grosor. De fácil montaje y desmontaje.

Square table for indoor and outdoor use made of very strong and durable resin reinforced with fiberglass. UV protection. Table top of tempered dark glass of 5 mm thickness. Easy to assemble and disassemble.

Table carrée pour usage intérieur et extérieur fabriquée en résine très solide et durable renforcée avec fibre de verre. Plateau en verre trempé foncé en 5 mm de grosueur. Montage et démontage faciles.

Units STD	Packaging Dimensions (cm)	m3/ pack	NW Unit (kg)	Units Container 20'	Units Container 40'	Units Container HC	Units Trayler (70m3)	Units Truck 100m3
1	96x96x14	0,129	22	220	460	640	640	800



Chocolate  
Chocolate  
Chocolat



Blanco  
White  
Blanc

**L** 94 x **W** 94 x **H** 75 cm

**L** 37 x **W** 37 x **H** 29.53 in

mesa / table / table

## Pacific



Mesa rectangular para uso interior y exterior fabricada en resina muy resistente y duradera reforzada con fibra de vidrio. Protección UV. Sobre de cristal templado oscuro de 5 mm de grosor. De fácil montaje y desmontaje.

Rectangular table for indoor and outdoor use made of very strong and durable resin reinforced with fiberglass. UV protection. Table top of tempered dark glass of 5 mm thickness. Easy to assemble and disassemble.

Table rectangulaire pour usage intérieur et extérieur fabriquée en résine très solide et durable renforcée avec fibre de verre. Plateau en verre trempé foncé en 5 mm de grosueur. Montage et démontage faciles.

Units STD	Packaging Dimensions (cm)	m3/ pack	NW Unit (kg)	Units Container 20'	Units Container 40'	Units Container HC	Units Trayler (70m3)	Units Truck 100m3
1	184x96x14	0,247	32	120	280	280	320	400



Chocolate  
Chocolate  
Chocolat

**L** 180 x **W** 94 x **H** 75 cm

**L** 70.87 x **W** 37 x **H** 29.53 in



tumbona / sunlounger / chaise longue

# Tropic



**CATAS®**

Seat static loading test according to EN 581-2 - 2011

Tumbona apilable. Respaldo de cinco posiciones, ruedas ocultas y gomas antideslizantes. Fabricada en resina muy resistente a la intemperie y duradera. Protección Rayos UV, que asegura que el color no se desvanezca. Sin estructura metálica. Para uso exterior.

Stackable sunlounger. Five position reclining sunlounger. Hidden wheels and anti-slippery rubbers. Made of very strong and durable resin, fiberglass reinforced. UV protection, which ensures that the color does not to fade. Without metallic structure. For outdoor use.

Chaise longue empilable pour utilisation extérieure. Roues invisibles et caoutchoucs anti-glissant. Fabriquée en résine très solide et durable, renforcée avec fibre de verre. Empilable. Protection UV. Sans métal.

Units STD	Packaging Dimensions (cm)	m3/ pack	NW Unit (kg)	Units Container 20'	Units Container 40'	Units Container HC	Units Trayler (70m3)	Units Truck 100m3
16	73x187x230	3,14	14	144	340	-	-	-
18	73x187x245	3,346	14	146	342	342	420	420



Chocolate

**W** 73 x **L** 187 x **H** 44 cm

Chocolate

**W** 28.74 x **L** 73.62 x **H** 17.32 in

Chocolat

## Cojín tumbona Tropic

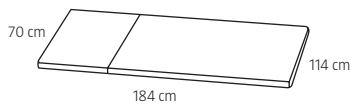

Beige pardo  
Brown beige  
Beige foncé

Cojín de poliéster de 5 cm de grosor en color beige pardo.

Polyester cushion 5 cm thickness in brown beige colour.

Coussin polyester de 5 cm de grosseur de couleur beige foncé.

Units STD	Packaging Dimensions (cm)	m3/ pack	NW Unit (kg)	Units Container 20'	Units Container 40'	Units Container HC	Units Trayler (70m3)	Units Truck 100m3
5	185x60x27	-	-	495	980	1.150	1.575	-

**W:** ancho / width / largeur    **L:** largo / length / longueur    **H:** altura / height / hauteur

RESOL Rattan inyectado







set / set / set

## Ipanema

Set compuesto por 1 sofá doble, 2 sillones, 1 mesa, 2 mesas auxiliares y 3 cojines. Conjunto de cojines de poliéster con 5 cm de grosor en color beige pardo incluidos en el Set.

Set consists of 1 double sofa, 2 armchairs, 1 table, 2 side tables and 3 cushions. Polyester cushions 5 cm thick brown beige included in the Set.

Set composé de 1 canapé deux places, 2 fauteuils, 1 table, 2 tables auxiliaires et 3 coussins. Coussins en polyester de 5 cm de grosseur beige foncé inclus avec le Set.



Chocolate  
Chocolate  
Chocolat



Cojín beige pardo  
Cushion brown beige  
Coussin beige foncé

Otros colores disponibles bajo pedido y plazo de entrega. Consultar Departamento Comercial.

Other colours available upon request, delivery time varies. Ask the Sales Department.

Autres couleurs disponibles sur commande et délai de livraison. Consulter le Département Commercial.



sillón / armchair / fauteuil

# Ipanema



**CATAS**

Seat static loading test according to EN 15373 LEVEL 2 - 2011

Sillón apilable para uso interior y exterior fabricada en resina muy resistente y duradera reforzada con fibra de vidrio. Protección UV.

Stackable armchair for indoor and outdoor use made of very strong and durable resin reinforced with fiberglass. UV protection.

Fauteuil empilable pour usage intérieur et extérieur fabriqué en résine très solide et durable renforcé avec fibre de verre. Protection UV.

Units STD	Packaging Dimensions (cm)	m3/ pack	NW Unit (kg)	Units Container 20'	Units Container 40'	Units Container HC	Units Traylor (70m3)	Units Truck 100m3
10	72x114x246	2,019	10	144	320	320	432	



Chocolate  
Chocolate  
Chocolat

**W** 76 x **L** 72 x **H** 89 x **Hs** 38 x **Ha** 67 cm

**W** 29.92 x **L** 28.35 x **H** 35.04 x **Hs** 14.96 x **Ha** 26.37 in

## Cojín sillón Ipanema

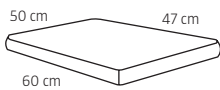

Beige pardo  
Brown beige  
Beige foncé

Cojín de poliéster de 5 cm de grosor en color beige pardo.

Polyester cushion 5 cm thickness in brown beige colour.

Coussin polyester de 5 cm de grosseur de couleur beige foncé.

Units STD	Packaging Dimensions (cm)	m3/ pack	NW Unit (kg)	Units Container 20'	Units Container 40'	Units Container HC	Units Traylor (70m3)	Units Truck 100m3
20	108x54x50	-	-	1.760	3.840	4.720	5.800	-

sofá / sofa / sofa

# Ipanema



**CATAS**

Seat static loading test according to EN 15373 LEVEL 2 - 2011

Sofá apilable para uso interior y exterior fabricada en resina muy resistente y duradera reforzada con fibra de vidrio. Protección UV.

Stackable sofa for indoor and outdoor use made of very strong and durable resin reinforced with fiberglass. UV protection.

Canapé empilable pour une utilisation intérieur et extérieur fabriqué en résine très solide et durable renforcé avec fibre de verre. Protection UV.

Units STD	Packaging Dimensions (cm)	m3/ pack	NW Unit (kg)	Units Container 20'	Units Container 40'	Units Container HC	Units Traylor (70m3)	Units Truck 100m3
10	128x114x246	3,589	14	90	180	180	240	-



Chocolate  
Chocolate  
Chocolat

**W** 128 x **L** 77 x **H** 89 x **Hs** 38 x **Ha** 67 cm

**W** 50.39 x **L** 30.31 x **H** 35.04 x **Hs** 14.96 x **Ha** 26.37 in

## Cojín sofá Ipanema

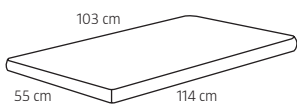

Beige pardo  
Brown beige  
Beige foncé

Cojín de poliéster de 5 cm de grosor en color beige pardo.

Polyester cushion 5 cm thickness in brown beige colour.

Coussin polyester de 5 cm de grosseur de couleur beige foncé.

Units STD	Packaging Dimensions (cm)	m3/ pack	NW Unit (kg)	Units Container 20'	Units Container 40'	Units Container HC	Units Traylor (70m3)	Units Truck 100m3
10	116x54x53	-	-	880	1.760	2.200	2.700	-

mesa de centro / coffee table / table basse

## Ipanema



Mesa de centro para uso interior y exterior fabricada en resina muy resistente y duradera reforzada con fibra de vidrio. Protección UV.

Coffee table for indoor and outdoor use made of very strong and durable resin reinforced with fiberglass. UV protection.

Table basse pour usage intérieur et extérieur fabriquée en résine très solide et durable renforcée avec fibre de verre. Protection UV.

Units STD	Packaging Dimensions (cm)	m3/ pack	NW Unit (kg)	Units Container 20'	Units Container 40'	Units Container HC	Units Traylor (70m3)	Units Truck 100m3
1	93x54x15	0,075	4	400	800	800	1.000	1.300



Chocolate  
Chocolate  
Chocolat



Blanco  
White  
Blanc

**L** 92 x **W** 53 x **H** 45 cm

**L** 36.22 x **W** 20.87 x **H** 17.72 in

mesa auxiliar / side table / table auxiliaire

## Ipanema



Mesa auxiliar para uso interior y exterior fabricada en resina muy resistente y duradera reforzada con fibra de vidrio. Protección UV.

Side table for indoor and outdoor use made of very strong and durable resin reinforced with fiberglass. UV protection.

Table auxiliaire pour usage intérieur et extérieur fabriquée en résine très solide et durable renforcée avec fibre de verre. Protection UV.

Units STD	Packaging Dimensions (cm)	m3/ pack	NW Unit (kg)	Units Container 20'	Units Container 40'	Units Container HC	Units Traylor (70m3)	Units Truck 100m3
1	47x47x15	0,033	2,5	900	1.800	1.800	2.400	3.000



Chocolate  
Chocolate  
Chocolat



Blanco  
White  
Blanc

**L** 45 x **W** 45 x **H** 45 cm

**L** 17.72 x **W** 17.72 x **H** 17.72 in



sillón / armchair / fauteuil

## Estoril



**CATAS**

Seat static loading test according to EN 1728:2000

Sillón apilable para uso interior y exterior fabricado en resina muy resistente y duradera reforzada con fibra de vidrio. Protección UV.

Stackable armchair for indoor and outdoor use made of very strong and durable resin reinforced with fiberglass. UV protection.

Fauteuil empilable pour usage intérieur et extérieur fabriqué en résine très solide et durable renforcé avec fibre de verre. Protection UV.

Units STD	Packaging Dimensions (cm)	m3/ pack	NW Unit (kg)	Units Container 20'	Units Container 40'	Units Container HC	Units Trayler (70m3)	Units Truck 100m3
20	77x75x223	1,29	7,5	480	1.020	-	1.140	-



L 74 x W 80 x H 75 cm

L 29.13 x W 31.50 x H 29.53 in



Chocolate

Chocolate

Chocolat



Blanco

White

Blanc

## Cojín sillón Estoril

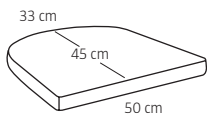

Beige pardo  
Brown beige  
Beige foncé

Cojín de poliéster de 5 cm de grosor en color beige pardo.

Polyester cushion 5 cm thickness in brown beige colour.

Coussin polyester de 5 cm de grosseur de couleur beige foncé.

Units STD	Packaging Dimensions (cm)	m3/ pack	NW Unit (kg)	Units Container 20'	Units Container 40'	Units Container HC	Units Trayler (70m3)	Units Truck 100m3
4	47x51x21	-	-	396	784	920	1.260	-

RESOL Rattan inyectado

butaca / armchair / fauteuil

## Algarve



**CATAS**

Butaca para uso interior y exterior fabricada en resina muy resistente y reforzada con fibra de vidrio. Protección UV. Montaje muy fácil. Peso neto 10 kg.

Armchair for indoor and outdoor use, made of very strong resin reinforced with fiberglass. UV Protection. Easy self assembling. Net weight 10 kg (22,05 lb).

Fauteuil pour usage intérieur et extérieur, fabriqué en résine très résistante renforcée avec fibre de verre. Protection UV. Montage très facile. Poids net 10 kg.

Units STD	Packaging Dimensions (cm)	m3/ pack	NW Unit (kg)	Units Container 20'	Units Container 40'	Units Container HC	Units Trayler (70m3)	Units Truck 100m3
2	92x43x52	0,206	10	256	650	-	724	-



Chocolate

Chocolate

Chocolat

W 59 x L 63 x H 90 x Hs 42 x Ha 66 cm

W 23.23 x L 24.80 x H 35.43 x Hs 16.54 x Ha 25.98 in

## Cojín sofá Algarve

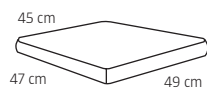

Beige pardo  
Brown beige  
Beige foncé

Cojín de poliéster de 5 cm de grosor en color beige pardo.

Polyester cushion 5 cm thickness in brown beige colour.

Coussin polyester de 5 cm de grosseur de couleur beige foncé.

Units STD	Packaging Dimensions (cm)	m3/ pack	NW Unit (kg)	Units Container 20'	Units Container 40'	Units Container HC	Units Trayler (70m3)	Units Truck 100m3
2	49x46x10	-	0,38	396	784	920	1.260	-





RESOL Rattan inyectado



**Sillas y Taburetes**  
**Chairs and Stools**  
**Chaises et Tabourets**

Edge Aluminio ..... 166	Tonic..... 168	Creta..... 172	Alegria taburete ..... 175
Edge PE..... 166	Cubic Textilene ..... 169	Palma ..... 172	Hal ..... 176
Edge Comfort Black ..... 166	Shio Textilene ..... 169	Inca ..... 172	Jed..... 176
Sea Aluminio ..... 167	Mamba Textilene ..... 169	Bcn ..... 174	Puzzle ..... 176
Alegria ..... 167	City ..... 170	Verona..... 174	
Alegria sillón ..... 167	Cool..... 170	Trevi ..... 174	
Alegria silla baja ..... 168	Iris ..... 171	Apolo banco ..... 175	
Alegria reposapiés ..... 168	Corfú ..... 171	Alu Alegria banco ..... 175	

**Mesas**  
**Tables**  
**Tables**

Puzzle ..... 177	Mamba ..... 183
Beach bar..... 178	Anywhere ..... 183
Ola ..... 179	Banyoles ..... 184
Ola 2 ..... 179	Esculapi ..... 184
Ola 3 ..... 179	Montblanc ..... 184
Raya ..... 180	Ripoll ..... 185
Raya 2 ..... 180	Rialp ..... 185
Raya 3 ..... 180	Nuria ..... 185
Compact ..... 181	Andorra mesa aux. .... 218
Alu Alegria ..... 181	Mónaco mesa aux. .... 218
Tonic..... 181	Shio aluminio mesa aux. ... 220
Shio Cristal ..... 182	Cubic aluminio mesa aux. ... 220
Cubic Cristal ..... 183	

**Pies**  
**Pedestals base**  
**Pieds**

Roc ..... 186	Max Alto ..... 192
Neo ..... 186	Sisley ..... 192
Dalí 40x40 ..... 187	
Dalí doble ..... 187	
Dalí ø40 ..... 187	
Dalí 110 ..... 188	
Miró 40x40 ..... 188	
Miró doble ..... 188	
Miró ø40 ..... 189	
Miró 110 ..... 189	
Tàpies ..... 189	
Max ..... 190	
Max 120 ..... 190	

RESOL CONTRACT ofrece una amplia gama de productos diseñados y desarrollados para asegurar el alto rendimiento requerido por el sector profesional. Con múltiples acabados, colores, combinaciones y materiales, el mobiliario RESOL CONTRACT se adapta a su medida para que pueda encontrar el producto que necesita en cada momento.

RESOL CONTRACT offers a wide range of products designed and developed to ensure the high resistance required for the professional market. With different finishes, colors, combinations and materials, RESOL CONTRACT furniture allows you to find the product you need at every moment.

RESOL CONTRACT offre un large éventail de produits conçus et développés pour les hautes performances requises par le secteur professionnel. Avec de multiples finitions, couleurs, combinaisons et accessoires, le mobilier RESOL CONTRACT vous permet de trouver le produit que vous avez besoin dans chaque situation.

## Sets

Set tea time .....	178
Set Clint .....	198
Set Jack .....	200
Set Humphrey .....	202
Set Bruno .....	204
Set Dream .....	206

## Tumbonas Sunloungers Chaises longues

Cubic Textilene .....	210
Shio Textilene .....	211
Comfort .....	211
Marina .....	212
Colores Textilenes .....	215
Costa Brava .....	216
Master .....	216

## Parasoles Parasols Parasols

Parasol A2 .....	221
Base emportable para A2 .....	221
Parasol LA2 .....	222
Parasol A1 .....	223
Parasol I1 .....	224
Parasol AM1 .....	225
Parasol M2 .....	226
Parasol A3 .....	227
One push .....	228
Strong 150 .....	229
Stone 25 .....	229
Siro 35 .....	229
Siro 15 .....	230
Flexo 35 .....	230
Marquesina .....	231

## Tableros Boards Panneaux

Tableros DUROLight .....	193
Tableros Werzalit .....	194
Tableros C. Fenólico .....	195
Combi. mesas .....	196

## Promocional Promotional Promotionnel

Promocional .....	232
-------------------	-----





sillón / armchair / fauteuil

## Edge Aluminio



ASOCIADO N°01684

**AIDIMA**  
INSTITUTO TECNOLÓGICO  
MUEBLE, MADERA, EMBALAJE Y AFINES

Seat static loading test according to EN 581 PÚBLICO - 2012

Sillón apilable para exterior. Estructura tubular doble,  $\varnothing$  25 mm, de aluminio anodizado brillante. Asiento y respaldo en lamas de aluminio estriado brillante. Tornillos de acero inoxidable, tuercas autoblocantes y conectores de aluminio.

Stackable armchair for outdoor use. Double tubular shaped structure,  $\varnothing$  25 mm, anodized aluminium, shiny finish. Seat and back with shiny striated aluminium slats. Stainless steel screws with self-locking nuts and aluminium connectors.

Fauteuil empilable pour extérieur. Structure tubulaire double,  $\varnothing$  25 mm, en aluminium anodisé brillant. Lattes du siège et dossier en aluminium brillant. Vis d'acier inoxydable, contre-écrou et entretoises en aluminium.

Units STD	Packaging Dimensions (cm)	m3/ pack	NW Unit (kg)	Units Container 20'	Units Container 40'	Units Container HC	Units Trayler (70m3)	Units Truck 100m3
16	66x58x235	0,86	3,32	608	1.216	1.216	1.344	1.472



Aluminio

Aluminum

Aluminium

**W** 56 x **L** 57 x **H** 81 cm

**W** 22.05 x **L** 22.44 x **H** 31.89 in

sillón / armchair / fauteuil

## Edge PE



Sillón apilable para exterior. Estructura tubular doble,  $\varnothing$  25 mm, de aluminio anodizado brillante. Asiento y respaldo en PE redondo de 3,5 mm de grosor con nervio interior de acero. Tornillos de acero inoxidable, tuercas autoblocantes y conectores de aluminio.

Stackable armchair for outdoor use. Tubular shaped structure,  $\varnothing$  25 mm, anodized aluminium, shiny finish. Round PE seat and back 3.5 mm thick with wire core. Stainless steel screws with self-locking nuts and aluminium connectors.

Fauteuil empilable pour extérieur. Structure tubulaire double,  $\varnothing$  25 mm, en aluminium anodisé brillant. Siège et dossier en PE rond de 3,5 mm avec noyau intérieur en d'acier. Vis d'acier inoxydable, contre-écrou et entretoises en aluminium.

Units STD	Packaging Dimensions (cm)	m3/ pack	NW Unit (kg)	Units Container 20'	Units Container 40'	Units Container HC	Units Trayler (70m3)	Units Truck 100m3
16	66x58x235	0,86	4,82	608	1.216	1.216	1.344	1.472



Burdeos

Burgundy

Bordeaux



Arena

Sand

Sable



Gris

Grey

Grey

**W** 56 x **L** 57 x **H** 81 cm

**W** 22.05 x **L** 22.44 x **H** 31.89 in

sillón / armchair / fauteuil

## Edge Comfort Black



Sillón apilable para exterior. Estructura tubular doble,  $\varnothing$  25 mm, de aluminio anodizado brillante. Asiento y respaldo en PE plano de 0,8 x 1,5 mm de grosor. Tornillos de acero inoxidable, tuercas autoblocantes y conectores de aluminio.

Stackable armchair for outdoor use. Tubular shaped structure,  $\varnothing$  25 mm, anodized aluminium, shiny finish. Flat PE seat and back 0.8 x 1.5 mm thickness. Stainless steel screws, self-locking nuts and aluminium connectors.

Fauteuil empilable pour extérieur. Structure tubulaire double,  $\varnothing$  25 mm, en aluminium anodisé brillant. Siège et dossier en PE plan de 0,8 x 1,5 mm. Vis en acier inoxydable, contre-écrou et entretoises en aluminium.

Units STD	Packaging Dimensions (cm)	m3/ pack	NW Unit (kg)	Units Container 20'	Units Container 40'	Units Container HC	Units Trayler (70m3)	Units Truck 100m3
15	63x58x235	0,86	4,82	570	1.140	1.140	1.260	1.380



Negro

Black

Noir

**W** 56 x **L** 57 x **H** 81 cm

**W** 22.05 x **L** 22.44 x **H** 31.89 in

sillón / armchair / fauteuil

## Sea Aluminio



ASOCIADO N°01684  
**AIDIMA**  
 INSTITUTO TECNOLÓGICO  
 MUEBLE, MADERA, EMBALAJE Y MÁS

Seat static loading test according to 581 PÚBLICO - 2012

Sillón apilable para exterior. Estructura tubular,  $\phi$  25 x 2 mm de grosor, de aluminio anodizado brillante. Asiento y respaldo en lamas de aluminio estriado brillante. Tornillos de acero inoxidable, tuercas autoblocantes y conectores de aluminio.

Stackable armchair for outdoor use. Tubular shaped structure,  $\phi$  25 x 2 mm thick, anodized aluminium, shiny finish. Seat and back with shiny striated aluminium slats. Stainless steel screws with self-locking nuts and aluminium connectors.

Fauteuil empilable pour extérieur. Structure tubulaire,  $\phi$  25 x 2 mm de grosueur, en aluminium anodisé brillant. Siège et dossier lattes en aluminium brillant. Vis en acier inoxydable, contre-écrou et entretoises en aluminium.

Units STD	Packaging Dimensions (cm)	m3/ pack	NW Unit (kg)	Units Container 20'	Units Container 40'	Units Container HC	Units Trayler (70m3)	Units Truck 100m3
16	59x58x235	0,8	3,42	608	1.216	1.216	1.408	1.600



W 49 x L 59 x H 77 cm

W 19.29 x L 23.23 x H 30.31 in



Aluminio

Aluminium

Aluminium

silla / chair / chaise

## Alegria



Silla apilable para uso interior y exterior de acero pintado por pulverización. Disponible en color blanco, negro y azul.

Stackable chair for indoor and outdoor use in powder coated steel. Available in white, black and blue.

Chaise empilable pour usage intérieur et extérieur en acier peint par pulvérisation. Disponible en couleur blanche, noire et bleue.

Units STD	Packaging Dimensions (cm)	m3/ pack	NW Unit (kg)	Units Container 20'	Units Container 40'	Units Container HC	Units Trayler (70m3)	Units Truck 100m3
28	92x50x230	1,06	4,4	-	1.232	1.364	-	-



4 u.

W 46 x L 57 x H 83 cm

W 18.11 x L 22.44 x H 32.68 in



Blanco

White

Blanc



Negro

Black

Noir



Azul

Blue

Bleu

sillón / armchair / fauteuil

## Alegria



Silla con brazos apilable para uso interior y exterior de acero pintado por pulverización. Disponible en color blanco, negro y azul.

Stackable armchair for indoor and outdoor use in powder coated steel. Available in white, black and blue.

Fauteuil empilable pour usage intérieur et extérieur en acier peint par pulvérisation. Disponible en couleur blanc, noir et bleu.

Units STD	Packaging Dimensions (cm)	m3/ pack	NW Unit (kg)	Units Container 20'	Units Container 40'	Units Container HC	Units Trayler (70m3)	Units Truck 100m3
28	92x58x230	1,23	5	-	1.232	1.364	-	-



4 u.

W 55 x L 57 x H 83 cm

W 21.65 x L 22.44 x H 32.68 in



Blanco

White

Blanc



Negro

Black

Noir



Azul

Blue

Bleu

W: ancho / width / largeur L: largo / length / longueur H: altura / height / hauteur



silla baja / low chair / chaise basse

## Alegria



Silla baja apilable para uso interior y exterior de acero pintado por pulverización. Disponible en color blanco, negro y azul.

Stackable low chair for indoor and outdoor use in powder coated steel. Available in white, black and blue.

Chaise basse empilable pour usage intérieur et extérieur en acier peint par pulvérisation. Disponible en couleur blanche, noire et bleue.

Units STD	Packaging Dimensions (cm)	m3/ pack	NW Unit (kg)	Units Container 20'	Units Container 40'	Units Container HC	Units Traylor (70m3)	Units Truck 100m3
26	65x112x215	1,56	6,2	-	936	1.080	-	-



**W** 62 x **L** 71 x **H** 66 cm  
**W** 24.41 x **L** 27.95 x **H** 25.98 in



Blanco  
White  
Blanc



Negro  
Black  
Noir



Azul  
Blue  
Bleu

reposapiés / footrest / répose pied

## Alegria



Reposapiés apilable para uso interior y exterior de acero pintado por pulverización. Disponible en color blanco, negro y azul.

Footrest for indoor and outdoor use in powder coated steel. Available in white, black and blue.

Table répose-pied empilable pour usage intérieur et extérieur en acier peint par pulvérisation. Disponible en couleur blanche, noire et bleue.

Units STD	Packaging Dimensions (cm)	m3/ pack	NW Unit (kg)	Units Container 20'	Units Container 40'	Units Container HC	Units Traylor (70m3)	Units Truck 100m3
40	110x130x215	3,07	4,4	-	720	936	-	-



Blanco  
White  
Blanc



Negro  
Black  
Noir



Azul  
Blue  
Bleu

**W** 53 x **L** 61 x **H** 33 cm  
**W** 20.86 x **L** 24.01 x **H** 12.99 in

RESOL Contract

sillón / armchair / fauteuil

## Tonic



Sillón apilable para exterior. Estructura de aluminio pintado por pulverización en color blanco. Asiento y respaldo de textilene color gris.

Stackable armchair for indoor and outdoor. Powder-coated aluminium structure in white. Seat and back of grey textilene.

Fauteuil d'intérieur et extérieur empilable. Structure en aluminium peinte par pulvérisation de couleur blanche. Siège et dossier en textilène gris.

Units STD	Packaging Dimensions (cm)	m3/ pack	NW Unit (kg)	Units Container 20'	Units Container 40'	Units Container HC	Units Traylor (70m3)	Units Truck 100m3
21	54x90x230	1,12	3,3	-	1.280	1.440	-	-



**W** 53 x **L** 60 x **H** 87 cm  
**W** 20.86 x **L** 23.62 x **H** 34.25 in



Blanco  
White  
Blanc

sillón / amchair / fauteuil

## Cubic Textilene



ASOCIADO N°01684  
**AIDIMA**  
INSTITUTO TECNOLÓGICO  
MUEBLE, MADERA, EMBALAJE Y ARTES

Sillón apilable para exterior. Estructura de aluminio pintado por pulverización en color gris claro. Asiento y respaldo de Textilene color negro. Embellecedor de madera ultratech en los apoyabrazos.

Stackable armchair for outdoor use. Powder-coated aluminium frame in light grey. Black Textilene seat and back. Ultratech wood trimming on the armrest.

Fauteuil empilable pour extérieur. Structure en aluminium peint par pulvérisation gris clair. Siège et dossier Textilène noir. Revêtement en bois ultratech sur les accoudoirs.

Units STD	Packaging Dimensions (cm)	m3/ pack	NW Unit (kg)	Units Container 20'	Units Container 40'	Units Container HC	Units Traylor (70m3)	Units Truck 100m3
27	58x95x235	1,29	3,2	600	1.275	1.275	1.400	1.500



**W 57 x L 54 x H 79 cm**  
**W 22.44 x L 21.26 x H 31.10 in**



Gris oscuro  
Dark grey  
Gris fonse

sillón / amchair / fauteuil

## Shio Textilene



ASOCIADO N°01684  
**AIDIMA**  
INSTITUTO TECNOLÓGICO  
MUEBLE, MADERA, EMBALAJE Y ARTES

Sillón apilable para exterior. Estructura de aluminio pintado por pulverización en color blanco. Asiento y respaldo de Textilene de color blanco. Embellecedor de madera ultratech en los apoyabrazos. Uniones de soldadura reforzados.

Stackable armchair for outdoors. Powder-coated aluminium structure in white. Seat and back of white Textilene. Ultratech wood trimming on the armrests. Reinforced welded joints.

Fauteuil d'extérieur empilable. Structure en aluminium peint par pulvérisation de couleur blanche. Siège et dossier en Textilène blanc. Revêtement en bois ultratech sur les accoudoirs. Raccords en soudure renforcés.

Units STD	Packaging Dimensions (cm)	m3/ pack	NW Unit (kg)	Units Container 20'	Units Container 40'	Units Container HC	Units Traylor (70m3)	Units Truck 100m3
26	58x92x228	1,22	3	624	1.248	1.248	1.456	1.664



**W 57 x L 58 x H 80 cm**  
**W 22.44 x L 22.83 x H 31.50 in**



Blanco  
White  
Blanc

sillón / amchair / fauteuil

## Mamba Textilene



**W:** ancho / width / largeur   **L:** largo / length / longueur   **H:** altura / height / hauteur

Sillón apilable para exterior. Estructura de aluminio pintado por pulverización en color negro. Asiento y respaldo de Textilene de color negro. Uniones de soldadura reforzados.

Stackable armchair for outdoors. Spray painted aluminium structure in black Textilene. Seat and back in black Textilene. Reinforced welded joints.

Fauteuil d'extérieur empilable. Structure en aluminium peint par pulvérisation de couleur noir. Siège et dossier en noir. Raccords en soudure renforcés.

Units STD	Packaging Dimensions (cm)	m3/ pack	NW Unit (kg)	Units Container 20'	Units Container 40'	Units Container HC	Units Traylor (70m3)	Units Truck 100m3
26	59x91x230	1,23	3	676	1.352	1.352	1.568	1.792



**W 57 x L 57 x H 80 cm**  
**W 22.44 x L 22.44 x H 31.50 in**



Negro  
Black  
Noir



sillón / amchair / fauteuil

# City

DESIGNED BY TONI CLARIANA



Sillón apilable para uso interior y exterior en polipropileno inyectado. Tacos de goma antideslizante. Peso neto 3,1 kg. Protección UV. Acabado texturizado mate.

Stackable armchair for outdoor and indoor use, injected polypropylene. Rubber non-slip feet. Net weigh 3,1 kg (6.83 lb). Protection UV. Textured matt finish.

Fauteuil empilable pour extérieur et intérieur, en polypropylène. Patins de caoutchouc antidérapants. Poids net 3,1 kg. Protection UV. Finition texturée mate.

Units STD	Packaging Dimensions (cm)	m3/ pack	NW Unit (kg)	Units Container 20'	Units Container 40'	Units Container HC	Units Traylor (70m3)	Units Truck 100m3
33	58x58x220	0,74	3,1	1.240	2.480	2.480	2.852	3.100
132	115x120x230	3,036	3,1	1.188	2.640	2.640	2.904	3.696



**W** 57,1 x **L** 57,1 x **H** 79,9 cm

**W** 22.48 x **L** 22.48 x **H** 31.46 in



Violeta  
Violet  
Violette



Naranja  
Orange  
Orange



Gris oscuro  
Dark grey  
Gris foncé



Verde lima  
Lime green  
Vert lime



Blanco  
White  
Blanc

sillón / amchair / fauteuil

# Cool



Sillón apilable para exterior de polipropileno inyectado. Tacos de goma antideslizantes. Peso neto: 3,18 kg. Protección UV. Acabado texturizado mate.

Stackable armchair for outdoor use. Injected polypropylene. Rubber non-slip feet. Net weight: 3.18 kg (6.99 lb). Protection UV. Textured matt finish.

Fauteuil empilable pour extérieur en polypropylène. Patins de caoutchouc antidérapants. Poids net: 3,18 Kg. Protection UV. Finition texturée mate.

Units STD	Packaging Dimensions (cm)	m3/ pack	NW Unit (kg)	Units Container 20'	Units Container 40'	Units Container HC	Units Traylor (70m3)	Units Truck 100m3
31	60x60x222	0,79	3,18	837	1.860	1.860	2.728	3.069
124	115x120x220	3,04	3,18	1.116	2.480	2.480	2.728	3.472
132	120x115x222	3,06	3,18	1.056	2.640	2.640	2.904	3.432



**W** 58 x **L** 60 x **H** 79 cm

**W** 22.83 x **L** 23.62 x **H** 31.10 in



Violeta  
Violet  
Violette



Naranja  
Orange  
Orange



Gris oscuro  
Dark grey  
Gris foncé



Verde lima  
Lime green  
Vert lime



Blanco  
White  
Blanc

silla / chair / chaise

## Iris



Silla apilable para interior y exterior de polipropileno inyectado. Tacos de goma antideslizante. Peso neto: 2,85 kg. Protección UV.

Polypropylene-injected stackable chair for indoor and outdoor use. Rubber non-slip feet. Net weight: 2.85 kg (6.27 lb). Protection UV.

Chaise empilable en polypropylène pour intérieur et extérieur. Patins de caoutchouc antidérapants. Poids net: 2,85 kg. Protection UV.

Units STD	Packaging Dimensions (cm)	m3/ pack	NW Unit (kg)	Units Container 20'	Units Container 40'	Units Container HC	Units Trayler (70m3)	Units Truck 100m3
30	80x110x155	1,36	2,85	640	1.230	1.440	1.500	2.160
52	80x110x220	1,94	2,85	1040	1.560	1.560	1.872	2.028



**W** 43 x **L** 47 x **H** 88 cm

**W** 16.93 x **L** 18.50 x **H** 34.64 in



Blanco  
White  
Blanc



Verde oscuro  
Dark green  
Vert foncé



Violeta  
Violet  
Violette



Naranja  
Orange  
Orange



Verde lima  
Lime green  
Vert lime



Gris oscuro  
Dark grey  
Gris foncé

sillón / armchair / fauteuil

## Corfú

**novedad**  
new nouveauté



Sillón apilable para exterior de polipropileno inyectado. Peso neto 3,22 kg. Protección UV. Acabado texturizado mate.

Stackable armchair for outdoor use. Injected polypropylene. Net weight 3.22 kg (7.08 lb). Protection UV. Textured matt finish.

Fauteuil empilable pour extérieur en polypropylène. Poids net 3,22 kg. Protection UV. Finition texturée mate.

Units STD	Packaging Dimensions (cm)	m3/ pack	NW Unit (kg)	Units Container 20'	Units Container 40'	Units Container HC	Units Trayler (70m3)	Units Truck 100m3
22	87x56x210	2,005	3,22	572	1210	1.210	1.496	1.562



**W** 58 x **L** 63 x **H** 91 cm

**W** 22.83 x **L** 24.80 x **H** 35.83 in



Blanco  
White  
Blanc



Gris oscuro  
Dark grey  
Gris foncé



Rojo  
Red  
Rouge



sillón / armchair / fauteuil

## Creta

novedad  
new nouveauté



Sillón apilable para exterior de polipropileno inyectado. Peso neto 3,02 kg. Protección UV. Acabado texturizado mate.

Stackable armchair for outdoor use. Injected polypropylene. Net weight 3.02 kg (6.64 lb). Protection UV. Textured matt finish.

Fauteuil empilable pour extérieur en polypropylène. Poids net 3,02 kg. Protection UV. Finition texturée mate.

Units STD	Packaging Dimensions (cm)	m3/ pack	NW Unit (kg)	Units Container 20'	Units Container 40'	Units Container HC	Units Traylor (70m3)	Units Truck 100m3
32	60x57x220	0,752	3,02	1.024	2.560	-	-	-



W 56 x L 58 x H 82 cm

W 22.05 x L 22.83 x H 32.28 in



Blanco  
White  
Blanc



Gris oscuro  
Dark grey  
Gris foncé



Rojo  
Red  
Rouge

sillón / armchair / fauteuil

## Palma



Sillón apilable para exterior de polipropileno inyectado. Peso neto 2,60 kg. Protección UV.

Stackable armchair for outdoor use. Injected polypropylene. Net weight 2.60 kg (5.72 lb). Protection UV.

Fauteuil empilable pour extérieur en polypropylène. Poids net 2,60 kg. Protection UV.

Units STD	Packaging Dimensions (cm)	m3/ pack	NW Unit (kg)	Units Container 20'	Units Container 40'	Units Container HC	Units Traylor (70m3)	Units Truck 100m3
25	55x62x220	0,75	2,6	850	1.900	-	-	-
116	115x120x245	3,38	2,6	-	-	2.320	2.552	-



W 62 x L 55 x H 84 cm

W 24.41 x L 21.65 x H 33.07 in



Blanco  
White  
Blanc



Verde oscuro  
Dark green  
Vert foncé



Wengé  
Wenge  
Wengé

sillón / armchair / fauteuil

## Inca



Sillón apilable para exterior de polipropileno inyectado. Peso neto 2,60 kg. Protección UV.

Stackable armchair for outdoor use. Injected polypropylene. Net weight 2.60 kg (5.72 lb). Protection UV.

Fauteuil empilable pour extérieur en polypropylène. Poids net 2,60 kg. Protection UV.

Units STD	Packaging Dimensions (cm)	m3/ pack	NW Unit (kg)	Units Container 20'	Units Container 40'	Units Container HC	Units Traylor (70m3)	Units Truck 100m3
25	55x62x220	0,75	2,6	850	1.900	-	-	-
116	115x120x245	3,38	2,6	-	-	2.320	2.552	-



W 62 x L 55 x H 84 cm

W 24.41 x L 21.65 x H 33.07 in



Violeta  
Violet  
Violette



Naranja  
Orange  
Orange



Verde lima  
Lime green  
Vert lime



Blanco  
White  
Blanc







sillón / armchair / fauteuil

## Bcn



Sillón apilable para exterior de polipropileno inyectado, con pata tubular muy resistente. Peso neto 3,90 kg. Protección UV.

Stackable injected polypropylene armchair for outdoors, with extra resistant tubular legs. Net weight 3.90 kg (8.58 lb). Protection UV.

Fauteuil d'extérieur empilable en polypropylène injecté, avec pied tubulaire super-résistant. Poids net 3,90 kg. Protection UV.

Units STD	Packaging Dimensions (cm)	m3/ pack	NW Unit (kg)	Units Container 20'	Units Container 40'	Units Container HC	Units Traylor (70m3)	Units Truck 100m3
21	63x96x225	1,36	3,90	500	1.000	1.050	1.176	1.260



W 48 x L 58 x H 90 cm

W 18.90 x L 22.83 x H 35.43 in



Blanco

White

Blanc



Verde oscuro

Dark green

Vert foncé

sillón / armchair / fauteuil

## Verona



Sillón apilable para exterior de polipropileno inyectado, con pata tubular súper resistente. Peso neto: 3,67 kg. Protección UV.

Stackable injected polypropylene armchair for outdoors, with extra resistant tubular legs. Net weight: 3.67 kg. (8.07 lb). Protection UV.

Fauteuil d'extérieur empilable en propylène injecté, avec pied tubulaire super-résistant. Poids net: 3,67 kg. Protection UV.

Units STD	Packaging Dimensions (cm)	m3/ pack	NW Unit (kg)	Units Container 20'	Units Container 40'	Units Container HC	Units Traylor (70m3)	Units Truck 100m3
21	58x95x230	1,27	3,67	500	1.000	1.050	1.176	1.260



W 48 x L 58 x H 90 cm

W 18.90 x L 22.83 x H 35.44 in



Onyx

Onyx

Onyx

sillón / armchair / fauteuil

## Trevi



Sillón apilable para exterior en polipropileno inyectado. Sistema de evacuación de agua. Peso neto: 3,03 kg. Protección UV

Stackable injected polypropylene armchair for outdoors. Water drainage system. Net weight 3,03 kg (6.68 lb). Protection UV.

Fauteuil d'extérieur empilable en propylène injecté. Systeme d'évacuation d'eau. Poids net 3,03 kg. Protection UV.

Units STD	Packaging Dimensions (cm)	m3/ pack	NW Unit (kg)	Units Container 20'	Units Container 40'	Units Container HC	Units Traylor (70m3)	Units Truck 100m3
54	80x115x244	2,245	3,03		1.380	1.620	2.240	2.280



W 55 x L 54 x H 90 cm

W 21.65 x L 21.26 x H 35.43 in



Onyx

Onyx

Onyx

banco / bench / banc

## Apolo



Banco para exterior de 150 cm con lamas de PVC. Peso neto 16,24 kg.

Bench for outdoors of 150 cm with PVC slats. Net weight 16.24 kg (35.73 lb).

Banc pour extérieur de 150 cm avec lattes de PVC. Poids net 16,24 kg.

Units STD	Packaging Dimensions (cm)	m3/ pack	NW Unit (kg)	Units Container 20'	Units Container 40'	Units Container HC	Units Trayler (70m3)	Units Truck 100m3
1	77x153x14	0,165	16,24	170	340	420	450	520
17	77x153x253	2,98	16,24				425	510



Blanco

White

Blanc

**W** 75 x **L** 150 x **H** 75 cm

**W** 29.53 x **L** 59.05 x **H** 29.53 in

banco / bench / banc

## Alu Alegria



Banco apilable para uso interior y exterior de aluminio pintado por pulverización. Disponible en color blanco, negro y azul.

Stackable bench for indoor and outdoor use in powder coated aluminium. Available in white, black and blue.

Banc empilable pour usage intérieur et extérieur peint par pulvérisation. Disponible en couleur blanc, noir et bleu.

Units STD	Packaging Dimensions (cm)	m3/ pack	NW Unit (kg)	Units Container 20'	Units Container 40'	Units Container HC	Units Trayler (70m3)	Units Truck 100m3
18	120x97x195	2,27	7,26	216	456	-	-	-



**W** 57 x **L** 118 x **H** 82 cm

**W** 22.44 x **L** 46.45 x **H** 32.28 in



Blanco

White

Blanc



Negro

Black

Noir



Azul

Blue

Bleu

taburete / stool / tabouret

## Alegria

novedad  
new nouveauté



Taburete apilable para uso interior y exterior de acero pintado por pulverización. Disponible en color blanco y negro.

Stackable stool for indoor and outdoor use in powder coated steel. Available in white and black.

Tabouret empilable pour usage intérieur et extérieur en acier peint par pulvérisation. Disponible en couleur blanche et noire.

Units STD	Packaging Dimensions (cm)	m3/ pack	NW Unit (kg)	Units Container 20'	Units Container 40'	Units Container HC	Units Trayler (70m3)	Units Truck 100m3
1	56x105x220	0,303	6	550	1.100	1.320	-	-



Blanco

White

Blanc



Negro

Black

Noir

**W** 52 x **L** 56 x **H** 104 cm

**W** 20.47 x **L** 22.05 x **H** 40.94 in

**W:** ancho / width / largeur **L:** largo / length / longueur **H:** altura / height / hauteur



taburete / stool / tabouret

## Jed



Taburete para interior con asiento de PVC y espuma de color negro. Estructura de acero cromado.

Indoor stool with a PVC and foam seat in black colour. Chromed steel structure.

Tabouret d'intérieur avec siège en PVC et mousse couleur noire. Structure en acier chromé.

Units STD	Packaging Dimensions (cm)	m3/ pack	NW Unit (kg)	Units Container 20'	Units Container 40'	Units Container HC	Units Traylor (70m3)	Units Truck 100m3
2	55x43x27	0,06	6	830	1.800	2.100	2.160	2.700



Negro  
Black  
Noir

**W** 44 x **L** 43 x **H** 63-83 cm

**W** 17.32 x **L** 16.93 x **H** 24.80-32.68 in

taburete / stool / tabouret

## Hal



Taburete para interior con asiento de ABS de 10 mm. Estructura de acero cromado.

Indoor stool with ABS of 10 mm seat. Chromed steel structure.

Tabouret d'intérieur avec siège en ABS de 10 mm. Structure en acier chromé.

Units STD	Packaging Dimensions (cm)	m3/ pack	NW Unit (kg)	Units Container 20'	Units Container 40'	Units Container HC	Units Traylor (70m3)	Units Truck 100m3
1	45x18x41	0,03	6	900	1.800	2.060	2.120	2.878



Blanco  
White  
Blanc

**W** 37 x **L** 37 x **H** 66-89 cm

**W** 14.57 x **L** 14.57 x **H** 25.98-35.04 in

taburete / stool / tabouret

## Puzzle



**W** 35 x **L** 35 x **H** 80 cm

**W** 13.78 x **L** 13.78 x **H** 31.50 in

Taburete para interior y exterior con estructura de aluminio mate de 40x40 mm y un grosor de 2 mm, con asientos de compacto fenólico en blanco y negro de 35x35cm. Se entrega desmontado en un óptimo packaging.

Stool for indoor and outdoor use with 40x40mm matt aluminium structure and 2 mm thickness, with white and black HPL seats. Delivered unassembled in an optimal packaging.

Tabouret pour usage intérieur et extérieur avec une structure mate de 40x40mm et une épaisseur de 2mm, avec siège en résine phénolique noire et blanche. Livré démonté dans un packaging optimal.

Units STD	Packaging Dimensions (cm)	m3/ pack	NW Unit (kg)	Units Container 20'	Units Container 40'	Units Container HC	Units Traylor (70m3)	Units Truck 100m3
1	-	-	8,25	-	-	-	-	-

estructura / structure / structure



Mate  
Matt  
Mat

tablero / table top / tableau



Blanco  
White  
Blanc



Negro  
Black  
Noir

mesa / table / table

## Puzzle

Programa de mesas para interior y exterior con estructura de aluminio mate de 40x40 mm y un grueso de 2 mm, con sobres de compacto fenólico en blanco y negro de 80x80, 180x90, 60x60 (alta), 100x60 (alta). Se entrega desmontado en un óptimo packaging.

Table program for indoor and outdoor use with 40x40mm matt aluminium structure and 2 mm thickness, with table tops white and black of 80x80cm, 180x90cm, 60x60cm (high), 100x60 (high). Delivered unassembled in an optimal packaging.

Programme de tables pour usage intérieur et extérieur avec une structure mate de 40x40mm et une épaisseur de 2mm, avec tableaux de 80x80cm, 180x90cm, 60x60cm (haute), 100x60 (haute). Livré démonté dans un packaging optimal.

Units STD	Packaging Dimensions (cm)	m3/ pack	NW Unit (kg)	Units Container 20'	Units Container 40'	Units Container HC	Units Traylor (70m3)	Units Truck 100m3
1	80x80x10	0,064	10,25	300	600	600	720	840
1	180x90x10	0,162	25	90	195	195	210	255
1	60x60x10	0,036	8	500	1.000	1.000	1.200	1.400
1	100x60x10	0,06	12,5	300	600	600	720	840

estructura / structure / structure

tablero / table top / tableau



Mate  
Matt  
Mat



Blanco  
White  
Blanc



Negro  
Black  
Noir



**W** 80 x **L** 80 x **H** 74 cm  
**W** 31.49 x **L** 31.49 x **H** 29.13 in



**W** 180 x **L** 90 x **H** 74 cm  
**W** 70.86 x **L** 35.43 x **H** 29.13 in



**W** 60 x **L** 60 x **H** 112 cm  
**W** 23.62 x **L** 23.62 x **H** 44.29 in



**W** 100 x **L** 60 x **H** 112 cm  
**W** 39.37 x **L** 23.62 x **H** 44.29 in



set / set / set

## Tea Time



Set compuesto por dos sillas y una mesa plegables, fabricados en acero pintado por pulverización, disponible en color blanco, naranja y verde. Peso silla 5 kg, peso mesa 5,5 kg.

Set composed by two folding chairs and table in powder coated steel, available in white, orange and green. Chair's net weight 5 kg (11,023 lb), table's net weight 5,5 kg (12,12 lb).

Set composé par deux chaises et une table pliante, fabriqués en acier peint par pulvérisation, disponibles en couleur blanche, orange et vert. Poids net chaise 5 kg, poids net table 5,5 kg.

Units STD	Packaging Dimensions (cm)	m3/ pack	NW Unit (kg)	Units Container 20'	Units Container 40'	Units Container HC	Units Trayler (70m3)	Units Truck 100m3
1	96x12x84	0,097	16	180	360	360	432	504

**W** 45 x **L** 45 x **H** 82 cm

**W** 17.72 x **L** 17.72 x **H** 32.28 in

Ø 60 x **H** 71 cm

Ø 23.62 x **H** 27.95 in



Blanco

White

Blanc



Verde

Green

Vert



Naranja

Orange

Orange

mesa / table / table

## Beach bar



Mesa monobloc apilable para exterior inyectada en polipropileno. Protección UV. Con agujero para sombrilla. Peso neto 4,75 kg.

Monoblock stackable table for outdoor use injected in polypropylene. UV protection. It has a hole for umbrella.

Table monobloc empilable pour extérieur injectée en polypropylène. Protection UV. Avec trou de parasol.

Units STD	Packaging Dimensions (cm)	m3/ pack	NW Unit (kg)	Units Container 20'	Units Container 40'	Units Container HC	Units Trayler (70m3)	Units Truck 100m3
27	75x82x225	1,384	4,75	486	1,107	1,107	-	-

**W** 70 x **L** 70 x **H** 72 cm

**W** 27.56 x **L** 27.56 x **H** 28.35 in



Blanco

White

Blanc



Verde oscuro

Dark green

Vert foncé

Ø: diámetro / diameter / diamètre L: largo / length / longueur W: ancho / width / largeur H: altura / height / hauteur



mesa / table / table

## Ola



Mesa apilable redonda (ø 60 / ø 70 cm) para exterior. Estructura tubular, ø 28 x 2 mm de grosor, de aluminio anodizado brillante. Tablero repulsado de 20 mm con interior aglomerado de alta densidad con tratamiento ignífugo e hidrófugo. Tornillos de acero inoxidable.

Stackable round table (ø 60 / ø 70 cm) for outdoor use. Tubular shaped frame, ø 28 x 2 mm thick, anodized aluminium, shiny finish. Stainless steel bevelled table top 20 mm thick. High density conglomerate core with fire retardant and water repellent treatment. Stainless steel screws.

Table empilable ronde (ø 60 / ø 70 cm) pour extérieur. Structure tubulaire, ø 28 x 2 mm de grosueur, en aluminium anodisé brillant. Plateau inox repoussé de 20 mm. Avec intérieur aggloméré de haute densité avec traitement hydrofuge et antifeu. Vis en acier inoxydable.



ø 60 / ø 70 x H 70 cm  
ø 23.62 / ø 27.56 / ø 27.56 x H 27.56 in

Units STD	Packaging Dimensions (cm)	m3/ pack	NW Unit (kg)	Units Container 20'	Units Container 40'	Units Container HC	Units Trayler (70m3)	Units Truck 100m3
20	63x63x230	0,91	7,7	540	1.140	1.140	1.260	1.440
20	73x73x230	1,22	10,2	480	960	960	1.080	1.200

mesa / table / table

## Ola 2



Mesa apilable redonda (ø 60 cm) para exterior. Estructura tubular, ø 28 x 2 mm de grosor, de aluminio anodizado brillante. Tablero Werzalit. (Ver colores Werzalit en pág. 192-193).

Stackable round table (ø 60 cm) for outdoor use. Tubular shaped frame, ø 28 x 2 mm thick, anodized aluminium, shiny finish. Werzalit table top. (See Werzalit colours on p. 192-193).

Table empilable ronde (ø 60 cm) pour extérieur. Structure tubulaire, ø 28 x 2 mm de grosueur, en aluminium anodisé brillant. Plateau Werzalit. (Voir couleurs Werzalit pag. 192-193).



ø 60 H 72 cm  
ø 23.62 H 28.34 in

Units STD	Packaging Dimensions (cm)	m3/ pack	NW Unit (kg)	Units Container 20'	Units Container 40'	Units Container HC	Units Trayler (70m3)	Units Truck 100m3
20	63x63x230	0,91	7,7	540	1.140	1.140	1.260	1.440

mesa / table / table

## Ola 3



Mesa apilable redonda (ø 60 / ø 70 / ø 80 cm) para exterior. Estructura tubular, ø 28 x 2 mm de grosor, de aluminio anodizado brillante. Tablero Compacto Fenólico. (Ver colores Compacto Fenólico en pág. 192-193).

Stackable round table (ø 60 / ø 70 / ø 80 cm) for outdoor use. Tubular shaped frame, ø 28 x 2 mm thick, anodized aluminium, shiny finish. HPL table top. (See HPL colours on p. 192-193).

Table empilable ronde (ø 60 / ø 70 / ø 80 cm) pour extérieur. Structure tubulaire, ø 28 x 2 mm de grosueur, en aluminium anodisé brillant. Plateau Résine Phénolique. (Voir couleurs Résine Phénolique pag. 193-193).

Units STD	Packaging Dimensions (cm)	m3/ pack	NW Unit (kg)	Units Container 20'	Units Container 40'	Units Container HC	Units Trayler (70m3)	Units Truck 100m3
20	63x63x230	0,91	10,2	540	1.140	1.140	1.260	1.440
20	73x73x230	1,22	10,2	480	960	960	1.080	1.200
20	83x83x230	1,58	10,2	432	864	864	972	972



ø 60 / ø 70 / ø 80 cm x H 72 cm  
ø 23.62 / ø 27.56 / ø 31.49 in x H 28.34 in



mesa / table / table

## Raya



- L 60 x W 60 x H 70 cm
- L 23.62 x W 23.62 x H 27.56 in
- L 70 x W 70 x H 70 cm
- L 27.56 x W 27.56 x H 27.56 in
- L 80 x W 80 x H 70 cm
- L 31.50 x W 31.50 x H 27.56 in

Mesa apilable cuadrada (60 x 60 / 70 x 70 / 80 x 80 cm) para exterior. Estructura tubular,  $\varnothing$  28 x 2 mm de grosor, de aluminio anodizado brillante. Tablero inox repulsado de 20 mm con interior aglomerado de alta densidad con tratamiento ignífugo e hidrófugo. Tornillos de acero inoxidable.

Stackable square table (60 x 60 / 70 x 70 / 80 x 80 cm) for outdoor use. Tubular shaped frame,  $\varnothing$  28 x 2 mm thick, anodized aluminium, shiny finish. Stainless steel bevelled table top 20 mm thick. High density conglomerate core with fire retardant and water repellent treatment. Stainless steel screws.

Table empilable carrée (60 x 60 / 70 x 70 / 80 x 80 cm) pour extérieur. Structure tubulaire,  $\varnothing$  28 x 2 mm de grosseur, en aluminium anodisé brillant. Plateau inox repoussé de 20 mm avec intérieur aggloméré de haute densité avec traitement hydrofuge et antifeu. Vis en acier inoxydable.

Units STD	Packaging Dimensions (cm)	m3/ pack	NW Unit (kg)	Units Container 20'	Units Container 40'	Units Container HC	Units Trayler (70m3)	Units Truck 100m3
18	75x75x235	1,32	11,5	432	864	864	918	1.026
20	85x85x235	1,69	13,3	280	560	560	600	680
20	95x95x235	2,12	15,81	240	480	480	560	600

mesa / table / table

## Raya 2



- L 60 x W 60 x H 72 cm
- L 23.62 x W 23.62 x H 28.35 in
- L 70 x W 70 x H 72 cm
- L 27.56 x W 27.56 x H 28.35 in
- L 80 x W 80 x H 72 cm
- L 31.50 x W 31.50 x H 28.35 in

Mesa apilable cuadrada (60 x 60 / 70 x 70 / 80 x 80 cm) para exterior. Estructura tubular,  $\varnothing$  28 x 2 mm de grosor, de aluminio anodizado brillante. Tablero Werzalit. (Ver colores Werzalit en pág. 192-193).

Stackable square table (60 x 60 / 70 x 70 / 80 x 80 cm) for outdoor use. Tubular shaped frame,  $\varnothing$  28 x 2 mm thick, anodized aluminium, shiny finish. Werzalit table top. (See Werzalit colours on p. 192-193).

Table empilable carrée (60 x 60 / 70 x 70 / 80 x 80 cm) pour extérieur. Structure tubulaire,  $\varnothing$  28 x 2 mm de grosseur, en aluminium anodisé brillant. Plateau Werzalit. (Voir couleurs Werzalit pag. 192-193).

Units STD	Packaging Dimensions (cm)	m3/ pack	NW Unit (kg)	Units Container 20'	Units Container 40'	Units Container HC	Units Trayler (70m3)	Units Truck 100m3
18	75x75x235	1,32	11,5	432	864	864	918	1.026
20	85x85x235	1,69	13,3	280	560	560	600	680
20	95x95x235	2,74	15,81	240	480	480	560	600

mesa / table / table

## Raya 3



- L 60 x W 60 x H 72 cm
- L 23.62 x W 23.62 x H 28.35 in
- L 70 x W 70 x H 72 cm
- L 27.56 x W 27.56 x H 28.34 in
- L 80 x W 80 x H 72 cm
- L 31.50 x W 31.50 x H 28.34 in

Mesa apilable cuadrada (60 x 60 / 70 x 70 / 80 x 80 cm) para exterior. Estructura tubular,  $\varnothing$  28 x 2 mm de grosor, de aluminio anodizado brillante. Tablero Compacto Fenólico. (Ver colores Compacto Fenólico en pág. 192-193).

Stackable square table (60 x 60 / 70 x 70 / 80 x 80 cm) for outdoor use. Tubular shaped frame,  $\varnothing$  28 x 2 mm thick, anodized aluminium, shiny finish. HPL table top. (See HPL colours on p. 192-193).

Table empilable carrée (60 x 60 / 70 x 70 / 80 x 80 cm) pour extérieur. Structure tubulaire,  $\varnothing$  28 x 2 mm de grosseur, en aluminium anodisé brillant. Plateau Résine Phénolique. (Voir couleurs Résine Phénolique pag. 192-193).

Units STD	Packaging Dimensions (cm)	m3/ pack	NW Unit (kg)	Units Container 20'	Units Container 40'	Units Container HC	Units Trayler (70m3)	Units Truck 100m3
18	75x75x235	1,32	11,5	432	864	864	918	1.026
20	85x85x235	1,69	13,3	280	560	560	600	680
20	95x95x235	2,74	15,81	240	480	480	560	600

mesa / table / table

## Compact



**W** 70 x **L** 70 x **H** 73,6 cm  
**W** 27.55 x **L** 27.55 x **H** 28.97 in  
**W** 80 x **L** 80 x **H** 73,6 cm  
**W** 31.50 x **L** 31.50 x **H** 28.97 in

Mesa apilable cuadrada para uso interior y exterior. Estructura tubular de acero pintado por pulverización, disponible en color blanco y negro. Tablero disponible en compacto fenólico de 70x70 y 80x80 cm en color blanco, negro y silver.

Stackable squared table for indoor and outdoor use. Tubular powder coated steel structure, available in white and black. Table top available in HPL of 70x70 and 80x80 cm in white, black and silver.

Table empilable carrée pour usage intérieur et extérieur. Structure tubulaire en acier peint par pulvérisation, disponible en couleur blanche et noire. Tableau disponible en résine phénolique de 70x70 et 80x80 cm en couleur blanche, noire et silver.

Units STD	Packaging Dimensions (cm)	m3/ pack	NW Unit (kg)	Units Container 20'	Units Container 40'	Units Container HC	Units Trayler (70m3)	Units Truck 100m3
18	85x85x235	1,69	13,65	280	560	560	600	680
15	95x95x235	2,74	15,64	240	480	480	560	600

estructura / structure / structure



Blanco  
White  
Blanc



Negro  
Black  
Noir

tablero / table top / tableau



Blanco  
White  
Blanc



Negro  
Black  
Noir



Silver

mesa / table / table

## Alu Alegria



Mesa para uso interior y exterior de aluminio pintado por pulverización en color blanco. Disponible en formato 70x70 y 140x80.

Table for indoor and outdoor use in white powder coated aluminium. Available in 70x70 and 140x80 cm.

Table Alegria pour usage intérieure et extérieure peint par pulvérisation en couleur blanche. Disponible en 70x70 cm et 140x80 cm.

Units STD	Packaging Dimensions (cm)	m3/ pack	NW Unit (kg)	Units Container 20'	Units Container 40'	Units Container HC	Units Trayler (70m3)	Units Truck 100m3
14	100x100x235	2,35	8,8	495	990	-	-	-
14	162x162x235	6,17	13,17	264	528	-	-	-

**L** 70 x **W** 70 x **H** 75 cm  
**L** 27.56 x **W** 27.56 x **H** 29.52 in  
**L** 140 x **W** 80 x **H** 75 cm  
**L** 55.12 x **W** 31.50 x **H** 29.52 in



Blanco  
White  
Blanc

mesa / table / table

## Tonic



Mesa para uso interior y exterior de aluminio pintado por pulverización en color blanco. Sobre de cristal templado de 8 mm de grosor pintado en color gris.

White powder-coated aluminium table for indoor and outdoor use. Table top of painted tempered glass in grey with an 8 mm thickness.

Table pour usage intérieur ou extérieur en aluminium peint par pulvérisation de couleur blanc, avec plateau en verre trempé de 8 mm. de grosseur, peint en gris.

Units STD	Packaging Dimensions (cm)	m3/ pack	NW Unit (kg)	Units Container 20'	Units Container 40'	Units Container HC	Units Trayler (70m3)	Units Truck 100m3
1	153x9x93	0,128	21,5	-	308	-	-	-



**L** 150 x **W** 90 x **H** 73 cm  
**L** 59.05 x **W** 35.43 x **H** 28.74 in

Blanco  
White  
Blanc



mesa / table / table  
**Shio Cristal**



Mesa para uso interior y exterior de aluminio pintado por pulverización en color blanco. Sobre de cristal templado de 8 mm de grosor pintado en color blanco.

White powder-coated aluminium table for indoor and outdoor use. Table top of painted tempered glass in white with an 8 mm thickness.

Table pour usage intérieur ou extérieur en aluminium peint par pulvérisation de couleur blanc, avec plateau en verre trempé de 8 mm. de grosseur, peint en blanc.

Units STD	Packaging Dimensions (cm)	m3/ pack	NW Unit (kg)	Units Container 20'	Units Container 40'	Units Container HC	Units Trayler (70m3)	Units Truck 100m3
1	84x84x10	0,06	17,5	400	800	896	965	1.379



Blanco  
 White  
 Blanc

**L** 80 x **W** 80 x **H** 74 cm

**L** 31.50 x **W** 31.50 x **H** 29.13 in

**W:** ancho / width / largeur    **L:** largo / length / longueur    **H:** altura / height / hauteur



mesa / table / table

## Cubic Cristal



Mesa para uso interior y exterior de aluminio pintado por pulverización en gris claro. Sobre de cristal templado de 8 mm de grosor.

Light grey powder-coated aluminium table for indoor and outdoor use. 8 mm thickness tempered glass table top.

Table pour usage intérieur ou extérieur en aluminium peint par pulvérisation de couleur gris clair avec plateau en verre trempé de 8 mm.

Units STD	Packaging Dimensions (cm)	m3/ pack	NW Unit (kg)	Units Container 20'	Units Container 40'	Units Container HC	Units Trayler (70m3)	Units Truck 100m3
1	84x84x10	0,06	17,5	400	800	896	965	1.379



Aluminio  
Aluminium  
Aluminium

L 80 x W 80 x H 74 cm

L 31.50 x W 31.50 x H 29.13 in

mesa / table / table

## Mamba



Mesa para uso interior y exterior de aluminio pintado por pulverización en color negro. Sobre de cristal de 8 mm de grosor pintado en color negro.

Black Spray painted aluminium table for indoor and outdoor use. Table top of painted glass in black with 8 mm thickness.

Table pour usage intérieur et extérieur en aluminium peint par pulvérisation de couleur noir, Plateau en verre de 8 mm de grosseur, peint en noir.

Units STD	Packaging Dimensions (cm)	m3/ pack	NW Unit (kg)	Units Container 20'	Units Container 40'	Units Container HC	Units Trayler (70m3)	Units Truck 100m3
1	83x83x10	0,07	17	390	780	874	941	1.344



Negro  
Black  
Noir

L 80 x W 80 x H 74 cm

L 31.50 x W 31.50 x H 29.13 in

mesa / table / table

## Anywhere



Mesa apilable cuadrada de 70x70 con estructura de acero pintado por pulverización de color blanco y sobre inyectado de polipropileno blanco.

Stackable squared table 70x70 cm for indoor and outdoor use with white powder coated steel structure. Available in White.

Table empilable carrée pour une usage intérieure et extérieure. Structure tubulaire en acier peint par pulvérisation.

Units STD	Packaging Dimensions (cm)	m3/ pack	NW Unit (kg)	Units Container 20'	Units Container 40'	Units Container HC	Units Trayler (70m3)	Units Truck 100m3
20	85x85x235	1,69	7	280	560	560	600	680



Blanco  
White  
Blanc

L 70 x W 70 x H 74 cm

L 27.56 x W 27.56 x H 29.13 in

W: ancho / width / largeur L: largo / length / longueur H: altura / height / hauteur



mesa / table / table

## Banyoles



Mesa de polipropileno con pie central embutido.  
Peso neto  $\phi$  60: 7 kg.

Polypropylene table with pressure-fitted pedestal.  
Net weight  $\phi$  60: 7.00 kg (15.40 lb).

Table guéridon de polypropylène avec pied central emboîté.  
Poids net  $\phi$  60: 7 kg.

Units STD	Packaging Dimensions (cm)	m3/ pack	NW Unit (kg)	Units Container 20'	Units Container 40'	Units Container HC	Units Traylor (70m3)	Units Truck 100m3
1	61x77x15	0,08	6,65	420	840	1.000		
30	90x120x220	2,38	6,65	300	660	660	900	960



Blanco  
White  
Blanc

$\phi$  60 x H 73 cm  
 $\phi$  23.62 x H 28.74 in

mesa / table / table

## Esculapi



Mesa para uso exterior inyectada en polipropileno con pie central embutido con gran estabilidad. Disponible en redonda de  $\phi$ 70 cm y cuadrada de 70x70 cm.

Table for outdoor use injected in polypropylene with pressure-fitted pedestal base with great stability. Available in round  $\phi$ 70 cm and squared 70x70 cm.

Table pour usage extérieur, injectée en polypropylène avec pied central emboîté et grande stabilité. Disponible en ronde de  $\phi$ 70 cm et carrée de 70x70 cm.

Units STD	Packaging Dimensions (cm)	m3/ pack	NW Unit (kg)	Units Container 20'	Units Container 40'	Units Container HC	Units Traylor (70m3)	Units Truck 100m3
1	73x71x15	0,08	7,25	320	660	789		
30	90x140x220	2,77	7,25	270	630			
32	90x120x240	2,59	7,25			662	672	832
1	73x71x15	0,08	7,25	320	660	789		
30	90x140x220	2,77	7,25	270	630			
32	90x120x240	2,59	7,25			662	672	832



Blanco  
White  
Blanc

$\phi$  70 x H 73 cm  
 $\phi$  27.56 x H 28.74 in

L 70 x W 70 x H 73 cm  
L 27.56 x W 27.56 x H 28.74 in

mesa / table / table

## Montblanc



Mesa de 80 x 80 cm con sobre Werzalit. Pies atornillados de aluminio anodizado mate.

Table 80 x 80 cm with Werzalit table top. Screwed anodized aluminium legs. Matt finish.

Table 80 x 80 cm avec plateau Werzalit. Pieds vissés en aluminium anodisé mat.

Units STD	Packaging Dimensions (cm)	m3/ pack	NW Unit (kg)	Units Container 20'	Units Container 40'	Units Container HC	Units Traylor (70m3)	Units Truck 100m3
1	81x81x17	0,11	10,7	245	518	609	636	909

L 80 x W 80 x H 73 cm  
L 31.50 x W 31.50 x H 28.74 in



Stratos  
Stratos  
Stratos



Arce  
Maple  
Érable



Wengé  
Wenge  
Wengé



Blanco  
White  
Blanc

mesa / table / table

## Ripoll



Mesa de 120 x 80 cm con sobre Werzalit. Pies de aluminio anodizado mate.

Table 120 x 80 cm with Werzalit table top. Anodized aluminium legs. Matt finish.

Table 120 x 80 cm avec plateau Werzalit. Pieds en aluminium anodisé mat.

Units STD	Packaging Dimensions (cm)	m3/ pack	NW Unit (kg)	Units Container 20'	Units Container 40'	Units Container HC	Units Trayler (70m3)	Units Truck 100m3
1	121x82x17	0,17	16,1	124	254	302	312	422



Blanco

White

Blanc



Stratos

Stratos

Stratos



Wengé

Wenge

Wenge

L 120 x W 80 x H 73 cm

L 47.24 x W 31.50 x H 28.74 in

mesa / table / table

## Rialp



Mesa de 80 x 80 cm con sobre Werzalit. Pies de polipropileno.

Table 80 x 80 cm with Werzalit table top. Polypropylene legs.

Table 80 x 80 cm avec plateau Werzalit. Pieds en polypropylène.

Units STD	Packaging Dimensions (cm)	m3/ pack	NW Unit (kg)	Units Container 20'	Units Container 40'	Units Container HC	Units Trayler (70m3)	Units Truck 100m3
1	81x81x17	0,11	10,7	245	518	609	636	909



Blanco

White

Blanc

L 80 x W 80 x H 73 cm

L 31.50 x W 31.50 x H 28.74 in

mesa / table / table

## Núria



Mesa de 120 x 80 cm con sobre Werzalit. Pies atornillados de polipropileno.

Table 120 x 80 cm with Werzalit table top. Screwed polypropylene legs.

Table 120 x 80 cm avec plateau Werzalit. Pieds vissés en polypropylène.

Units STD	Packaging Dimensions (cm)	m3/ pack	NW Unit (kg)	Units Container 20'	Units Container 40'	Units Container HC	Units Trayler (70m3)	Units Truck 100m3
1	121x82x17	0,17	16,1	124	254	302	312	422



Blanco

White

Blanc

L 120 x W 80 x H 73 cm

L 47.24 x W 31.50 x H 28.74 in



pie / pedestal base / pied

## Roc



Pie central para mesa de interior y exterior en fundición de aluminio texturizado mate. Tubo de aluminio anodizado mate. Base de  $\varnothing$  51 cm. Contrapeso de acero de 3 kg. (Consultar tabla de combinaciones de pies y sobres en pág. 196).

Pedestal base table for indoor and outdoor use. Cast aluminium matt-textured finish. Matt finish anodized aluminium tube. Base of  $\varnothing$  51 cm. 3 kg (6.60 lb) steel counterweight. (See Table combination for pedestral bases and table tops on p.196).

Pied guéridon pour table d'intérieur ou extérieur. Pied en fonte en aluminium texturé mat. Tube en aluminium anodisé mat. Base de  $\varnothing$  51 cm. Contrepoids en acier de 3 kg. (Voir le tableau de combinaison pour pieds central et planches pag.196).

Units STD	Packaging Dimensions (cm)	m3/ pack	NW Unit (kg)	Units Container 20'	Units Container 40'	Units Container HC	Units Traylor (70m3)	Units Truck 100m3
1	53x53x15 + 10x10x73	0,04	8,66		1,425			



Aluminio  
Aluminium  
Aluminium

$\varnothing$  51 x H 71 cm  
 $\varnothing$  20.07 x H 27.95 in

pie / pedestal base / pied

## Neo



Pie central para mesa de interior y exterior en fundición de aluminio pintado mate. Tubo de aluminio anodizado con muesca antigiro. Contrapeso de acero de 5,80 kg. Niveladores en las 4 patas. (Consultar tabla de combinaciones de pies y sobres en pág. 196).

Pedestal base for indoor and outdoor table of cast aluminium painted matt. Anodized aluminium tube with a non-turning notch. Steel counterweight of 5,80 kg. (12.76 lb). Levellers on the four legs. (See Table combination for pedestral bases and table tops on p.196).

Pied central pour table d'intérieur et d'extérieur, en fonte en aluminium peint mat. Tube en aluminium anodisé avec encoche de fixation. Contrepoids en acier de 5,80 kg. Avec régulateurs aux 4 pieds. (Voir le tableau de combinaison pour pieds central et planches pag. 196).

Units STD	Packaging Dimensions (cm)	m3/ pack	NW Unit (kg)	Units Container 20'	Units Container 40'	Units Container HC	Units Traylor (70m3)	Units Truck 100m3
1	51x51x14 + 10x10x73	0,04	8,21	933	-	-	-	-



Mate  
Matt  
Mat



Blanco  
White  
Blanc

L 68 x W 68 x H 71 cm  
L 26.77 x W 26.77 x H 27.95 in

$\varnothing$ : diámetro / diameter / diamètre L: largo / length / longueur W: ancho / width / largeur H: altura / height / hauteur



pie / pedestal base / pied

## Dalí 40 x 40



Pie central para mesa de interior en acero inoxidable. Base de 40 x 40 cm. Tubo de aluminio anodizado de 80 x 80 mm con muesca antigiro. Altura de 73 cm. Peso 10,5 kg. (Consultar tabla de combinaciones de pies y sobres en pág. 196).

Pedestal base for indoor table in stainless steel. Base of 40 x 40 cm. 80 x 80 mm anodized aluminium tube with non-turn notch. Height 73 cm. Weight 10.5 kg (23.15 lb). (See combinations table for bases and table tops on p. 196).

Pied central pour table d'intérieur en acier inoxydable. Base de 40 x 40 cm. Tube en aluminium anodisé de 80 x 80 mm avec encoche de fixation. Hauteur 73 cm. Poids 10,5 kg. (Voir le table combinaisons pour pieds et plateaux pag. 196).

Units STD	Packaging Dimensions (cm)	m3/ pack	NW Unit (kg)	Units Container 20'	Units Container 40'	Units Container HC	Units Trayler (70m3)	Units Truck 100m3
1	42x42x7 + 11x11x73	0,06	20	466	933	1.100	1.133	1.633



Inox

**L** 40 x **W** 40 x **H** 73 cm

Inox

**L** 15.75 x **W** 15,75 x **H** 28.74 in

Inox

pie / pedestal base / pied

## Dalí doble



Pie central doble para mesa de interior en acero inoxidable. Base de 72 x 40 cm. Tubos de aluminio anodizado de 80 x 80 mm con muesca antigiro. Altura de 73 cm. Peso 19,5 kg. (Consultar tabla de combinaciones de pies y sobres en pág. 196).

Double pedestal base for indoor table in stainless steel. Base of 72 x 40 cm. 80 x 80 mm anodized aluminium tube with non-turn notch. Height 73 cm. Weight 19,5 kg (42.99 lb). (See Combinations table for bases and table tops on p. 196).

Double pied central pour table d'intérieur en acier inoxydable. Base de 72 x 40 cm. Tube en aluminium anodisé de 80 x 80 mm avec encoche de fixation. Hauteur 73 cm. Poids 19,5 kg. (Voir le tableau de combinaison pour pieds et plateaux pag. 196).

Units STD	Packaging Dimensions (cm)	m3/ pack	NW Unit (kg)	Units Container 20'	Units Container 40'	Units Container HC	Units Trayler (70m3)	Units Truck 100m3
1	42x84x7 + 11x11x73	0,06	32	466	933	1.100	1.133	1.633



Inox

**L** 72 x **W** 40 x **H** 73 cm

Inox

**L** 28.35 x **W** 15.75 x **H** 28.74 in

Inox

pie / pedestal base / pied

## Dalí ø40



Pie central para mesa de interior en acero inoxidable. Base de ø39 cm. Tubo de aluminio anodizado de ø 60 mm con muesca antigiro. Altura 73 cm. Peso 7,8 kg. (Consultar tabla de combinaciones de pies y sobres en pág. 196).

Pedestal base for indoor table in stainless steel. Base of ø39 cm. ø60 mm anodized aluminium tube with non-turn notch. Height 73 cm. Weight 7.8 kg. (17.20 lb). (See combinations table for bases and table tops on p. 196).

Pied central pour table d'intérieur en acier inoxydable. Base de ø 39 cm. Tube en aluminium anodisé en ø60 mm avec encoche de fixation. Hauteur 73 cm. Poids 7,8 kg. (Voir le table combinaisons pour pieds et plateaux pag. 196).

Units STD	Packaging Dimensions (cm)	m3/ pack	NW Unit (kg)	Units Container 20'	Units Container 40'	Units Container HC	Units Trayler (70m3)	Units Truck 100m3
1	42x42x7 + 11x11x73	0,06	16	466	933	1.100	1.133	1.633



Inox

**ø** 39 x **H** 73 cm

Inox

**ø** 15.35 x **H** 28.74 in

Inox



pie / pedestal base / pied

## Dalí 110



Pie central alto para mesa de interior en acero inoxidable. Base de  $\varnothing$  39 cm. Tubo de aluminio anodizado de  $\varnothing$  60 mm con muesca antigiro. Altura de 111 cm. Peso 8 kg. (Consultar tabla de combinaciones de pies y sobres en pág. 196).

High pedestal base for indoor table in stainless steel. Base of  $\varnothing$ 39 cm.  $\varnothing$ 60mm anodized aluminium tube with non-turn notch. Height 111 cm. Weight 8 kg (17.64 lb). (See combinations table for bases and table tops on p. 196).

Pied central haut pour table d'intérieur en acier inoxydable. Base de tube de  $\varnothing$ 39 cm. Tube en aluminium anodisé de  $\varnothing$ 60mm avec encoche de fixation. Hauteur 111 cm. Poids 8 kg. (Voir le table combinaisons pour pieds et plateaux pag. 196).

Units STD	Packaging Dimensions (cm)	m3/ pack	NW Unit (kg)	Units Container 20'	Units Container 40'	Units Container HC	Units Trayler (70m3)	Units Truck 100m3
1	42x42x7 + 10x10x110	0,06	20	466	933	1.100	1.133	1.633



Inox

$\varnothing$  39 x H 111 cm

Inox

$\varnothing$  15.35 x H 43.70 in

Inox

pie / pedestal base / pied

## Miró 40 x 40



Pie central para mesa de interior y exterior. Base de 40 x 40 cm en aluminio anodizado mate. Tubo de 80 x 80 mm de aluminio anodizado mate con muesca antigiro. Altura de 73,5 cm. Peso 11 kg. Con niveladores. (Consultar tabla de combinaciones de pies y sobres en pág. 196).

Pedestal base for indoor and outdoor table. Base of 40 x 40 cm in matt anodized aluminium. 80 x 80 mm matt anodized aluminium tube with non-turn notch. Height 73,5 cm. Weight 11 kg (24.25 lb). With levellers. (See combinations table for bases and table tops on p. 196).

Pied central pour table d'intérieur et d'extérieur. Base de 40 x 40 cm en aluminium anodisé mat. Tube de 80 x 80 mm en aluminium anodisé avec encoche de fixation. Hauteur 73,5 cm. Poids 11 kg. Avec niveleurs. (Voir le table combinaisons pour pieds et plateaux pag. 196).

Units STD	Packaging Dimensions (cm)	m3/ pack	NW Unit (kg)	Units Container 20'	Units Container 40'	Units Container HC	Units Trayler (70m3)	Units Truck 100m3
1	42x42x7 + 11x11x73	0,06	18	466	933	1.100	1.133	1.633



Aluminio

L 40 x W 40 x H 73,5 cm

Aluminium

L 15.75 x W 15.75 x H 28.94 in

Aluminium

pie / pedestal base / pied

## Miró doble



Pie central doble para mesa de interior y exterior. Base de 72x40cm en aluminio anodizado mate. Tubo de 80 x 80 mm en aluminio anodizado mate con muesca antigiro. Altura de 73,5 cm. Peso 20kg. Con niveladores. (Consultar tabla de combinaciones de pies y sobres en pág. 196).

Double pedestal base for indoor and outdoor table. Base of 72 x 40 cm in matt anodized aluminium. 80 x 80 mm matt anodized aluminium tube with non-turn notch. Height 73,5 cm. Weight 20 kg (44.09 lb). With levellers. (See combinations table for bases and table tops on p. 196).

Double pied central pour table d'intérieur et d'extérieur. Base de 72 x 40 cm en aluminium anodisé mat. Tube de 80 x 80 mm en aluminium anodisé mat avec encoche de fixation. Hauteur 73,5 cm. Poids 20 kg. Avec niveleurs. (Voir le table combinaisons pour pieds et plateaux pag. 196).

Units STD	Packaging Dimensions (cm)	m3/ pack	NW Unit (kg)	Units Container 20'	Units Container 40'	Units Container HC	Units Trayler (70m3)	Units Truck 100m3
1	42x84x7 + 22x11x73	0,06	31	466	933	1.100	1.133	1.633



Aluminio

L 70 x W 40 x H 73,5 cm

Aluminium

L 27.56 x W 15.75 x H 28.94 in

Aluminium

pie / pedestal base / pied

## Miró ø40



Pie central para mesa de interior y exterior. Base de Ø39 cm en aluminio anodizado mate. Tubo de Ø60 mm en aluminio anodizado mate con muesca antigiro. Altura de 73,5 cm. Peso 8,5 kg. Con niveladores. (Consultar tabla de combinaciones de pies y sobres en pág. 196).

Pedestal base for indoor and outdoor table. Base of Ø39 cm in matt anodized aluminium. Ø60 mm matt anodized aluminium tube with non-turn notch. Height 73,5 cm. Weight 8.5 kg. (18.74 lb). With levellers. (See combinations table for bases and table tops on p. 196).

Pied central pour table d'intérieur et extérieur. Base de Ø39 cm en aluminium anodisé mat. Tube de Ø 60 mm en aluminium anodisé mat avec encoche de fixation. Hauteur 73,5 cm. Poids 8,5 kg. Avec niveleurs. (Voir le table combinaisons pour pieds et plateaux pag. 196).

Units STD	Packaging Dimensions (cm)	m3/ pack	NW Unit (kg)	Units Container 20'	Units Container 40'	Units Container HC	Units Trayler (70m3)	Units Truck 100m3
1	42x42x7 + 11x11x73	0,06	15	466	933	1.100	1.133	1.633



Aluminio  
Aluminium  
Aluminium

ø 45 x H 73,5 cm

ø 17.72 x H 28.94 in

pie / pedestal base / pied

## Miró 110



PPie central alto para mesa de interior y exterior. Base de Ø39 cm en aluminio anodizado mate. Tubo de Ø60 mm en aluminio anodizado mate con muesca antigiro. Altura de 111,5 cm. Peso 9 kg. Con niveladores. (Consultar tabla de combinaciones de pies y sobres en pág. 196).

High pedestal base for indoor and outdoor table. Ø39 cm in matt anodized aluminium. Ø60 mm matt anodized aluminium tube with non-turn notch. Height 111,5 cm. Weight 9 kg. (19.84 lb). With levellers. (See Combinations table for bases and table tops on p. 196).

Pied central haut pour table d'intérieur et d'extérieur. Base de Ø39 cm en aluminium anodisé mat. Tube de Ø 60 mm en aluminium anodisé mat avec encoche de fixation. Hauteur 111,5 cm. Poids 9 kg. Avec niveleurs. (Voir le tableau de combinaison pour pieds et Plateaux pag. 196).

Units STD	Packaging Dimensions (cm)	m3/ pack	NW Unit (kg)	Units Container 20'	Units Container 40'	Units Container HC	Units Trayler (70m3)	Units Truck 100m3
1	42x42x7 + 10x10x110	0,06	18	466	933	1.100	1.133	1.633



Aluminio  
Aluminium  
Aluminium

ø 40 x H 111,5 cm

ø 15.75 x H 43.89 in

pie / pedestal base / pied

## Tàpies



Pie central de hierro fundido pintado en color negro, para mesa de uso interior. Columna de 80 x 80 mm con muesca antigiro. Base de 40 x 40 cm. Peso neto 20 kg. (Consultar tabla de combinaciones de pies y sobres en pág. 196).

Painted cast iron pedestal base table in black, for indoor use. 80 x 80 mm tube. Non-turn notch. Base of 40 x 40 cm. Net weight 20 kg (8.7 lb). (See Table combination for pedestral bases and table tops on p. 196).

Pied guéridon en font de fer peint en noir, pour table intérieur. Tube de 80x 80 mm avec encoche de fixation. Base de 40 x 40 cm. Poids net 20 Kg. (Voir le tableau de combinaison pour pieds central et planches pag. 196).

Units STD	Packaging Dimensions (cm)	m3/ pack	NW Unit (kg)	Units Container 20'	Units Container 40'	Units Container HC	Units Trayler (70m3)	Units Truck 100m3
1	42x42x7 + 11x11x73	0,06	20	466	933	1.100	1.133	1.633



Negro  
Black  
Noir



Blanco  
White  
Blanc

L 40 x W 40 x H 71 cm

L 15.75 x W 15.75 x H 27.95 in



pie / pedestal base / pied

## Max



Pie central para mesa de interior y exterior, en fundición de aluminio pintado brillante o mate. Tubo de aluminio anodizado  $\varnothing$  60 x 2 mm de grosor, con muesca anti-giro. Contrapeso de acero de 4,50 kg. Con reguladores en las 4 patas. (Consultar tabla de combinaciones de pies y sobres en pág. 196).

Pedestal base for indoor and outdoor table. Cast aluminium. Shiny or matt painted finish. Anodized aluminium tube,  $\varnothing$  60 x 2 mm thick. Non-turn notch. Steel counterweight 4.5 kg (9.90 lb). With regulators in all 4 legs. (See Table combination for pedestral bases and table tops on p.196).

Pied central pour table, intérieur ou extérieur, en fonte en aluminium peint brillant ou mat. Tube en aluminium anodisé  $\varnothing$  60 x 2 mm de grosseur. Encoche antigiratoire. Contrepoids en acier de 4,50 kg. Avec régulateurs aux 4 pieds. (Voir le tableau de combinaison pour pieds central et planches pag. 196).

Units STD	Packaging Dimensions (cm)	m3/ pack	NW Unit (kg)	Units Container 20'	Units Container 40'	Units Container HC	Units Traylor (70m3)	Units Truck 100m3
1	54x54x10 + 10x10x73	0,03	8,2	850	1.700	-	-	-



Brillante

Shiny

Brillant



Mate

Matt

Mat

L 53 x W 53 x H 71 cm

L 20.87 x W 20.87 x H 27.95 in

Atención: No recomendamos la versión en acabado brillante para ambientes salinos.

Attention: Shiny painted finish version not recommended for saline environments.

Attention: Nous ne recommandons pas la version brillante pour les environnements salins.

pie / pedestal base / pied

## Max 120



Pie central doble para mesa interior y exterior, en fundición de aluminio pintado brillante o mate. Tubo de aluminio anodizado de  $\varnothing$  60 x 2 mm de grosor, con muesca anti-giro. Contrapeso de acero: 4,50 kg. Con reguladores en las 4 patas. (Consultar tabla de combinaciones de pies y sobres en pág. 196).

Double pedestal base table for indoor and outdoor use, in shiny or matt polished cast aluminium. Anodized aluminium tube of  $\varnothing$  60 x 2 mm thickness. Non-turn notch. Steel counterweight: 4.5 kg (9.90 lb). With regulators in all 4 legs. (See Table combination for pedestral bases and table tops on p. 196).

Pied central pour table intérieur ou extérieur, en fonte en aluminium poli brillant ou mat. Tube en aluminium anodisé  $\varnothing$  60 x 2 mm de grosseur. Encoche anti giratoire. Contrepoids en acier: 4,50 kg. Avec régulateurs aux 4 pieds. (Voir le tableau de combinaison pour pieds central et planches pag. 196).

Units STD	Packaging Dimensions (cm)	m3/ pack	NW Unit (kg)	Units Container 20'	Units Container 40'	Units Container HC	Units Traylor (70m3)	Units Truck 100m3
1	80x62x11 + 10x10x73	0,54	10,8	516	1.032	-	-	-



Brillante

Shiny

Brillant



Mate

Matt

Mat

L 79 x W 43 x H 71 cm

L 31.10 x W 16.93 x H 27.95 in

Atención: No recomendamos la versión en acabado brillante para ambientes salinos.

Attention: Shiny painted finish version not recommended for saline environments.

Attention: Nous ne recommandons pas la version brillante pour les environnements salins.





pie / pedestal base / pied

## Max Alto



Pie central alto para mesa de interior y exterior, en fundición de aluminio brillante o pintado mate. Tubo de aluminio anodizado mate  $\phi$  60 x 2 mm de grosor, con muesca anti-giro. Contrapeso de acero: 4,50 kg. Con reguladores en las 4 patas. (Consultar tabla de combinaciones de pies y sobres en pág. 196).

Pedestal base for high table for indoor and outdoor use, in shiny cast aluminium or matt painted. Anodized aluminium tube, matt finish,  $\phi$  60 x 2 mm thickness, with non-turn notch. Steel counterweight: 4.5 kg (9.90 lb). With regulators in all 4 legs. (See Table combination for pedestral bases and table tops on p. 196).

Pied guéridon haut pour table, intérieur ou extérieur, en coulage en aluminium brillant ou peint mat. Tube en aluminium anodisé,  $\phi$  60 x 2 mm de grosseur. Encoche anti giratoire. Contrepoids en acier: 4,50 kg. Avec régulateurs aux 4 pieds. (Voir le tableau de combinaison pour pieds central et planches pag. 196).

Units STD	Packaging Dimensions (cm)	m <sup>3</sup> /pack	NW Unit (kg)	Units Container 20'	Units Container 40'	Units Container HC	Units Trayler (70m3)	Units Truck 100m3
1	53x53x9 8x8x110	0,02+0,01	8,7	750	1.500	-	-	-



Brillante

Shiny

Brillant



Mate

Matt

Mat

L 53 x W 53 x H 109 cm

L 20.86 x W 20.86 x H 42.91 in

Atención: No recomendamos la versión en acabado brillante para ambientes salinos.

Attention: Shiny painted finish version not recommended for saline environments.

Attention: Nous ne recommandons pas la version brillante pour les environnements salins.

pie / pedestal base / pied

## Sisley



Pie de mesa inyectado en aluminio pintado. Sistema abatible. Uso interior y exterior. (Consultar tabla de combinaciones de pies y sobres en pág. 196).

Table base of injected aluminum. Folding system. Indoor and outdoor use. (See Table combination for pedestral bases and table tops on p. 196).

Pie de table en aluminium injecté. Système de repliement. Utilisation intérieur et extérieur. (Voir le tableau de combinaison pour pieds central et planches pag. 196).

Units STD	Packaging Dimensions (cm)	m <sup>3</sup> /pack	NW Unit (kg)	Units Container 20'	Units Container 40'	Units Container HC	Units Trayler (70m3)	Units Truck 100m3
1	48x48x10 + 10x10x73	0,03	8,2	850	1.700	1.700	-	-



Gris

Grey

Gris



Negro

Black

Noir

L 48 x W 48 x H 72,5 cm

L 18.90 x W 18.90 x H 28.54 in

Atención: No recomendamos la versión en acabado brillante para ambientes salinos.

Attention: Shiny painted finish version not recommended for saline environments.

Attention: Nous ne recommandons pas la version brillante pour les environnements salins.

# Tablero DUROLight

## DUROLight table top

### Plateau DUROLight

Los tableros DUROLight son por su resistencia una opción idónea para el uso interior, y perfectamente combinable con la gama de sillas de Resol Contract. Están realizados de melamina con una imprimación de resina en la superficie que los protege de arañazos y de altas temperaturas (hasta 180°C). Los cantos están sellados con ABS para garantizar un acabado perfecto y resistente (Pruebas realizadas demuestran que son necesarios más de 1.5 Newton para conseguir arañar la superficie y 350 rotaciones para que se experimente desgaste.) Disponibles en color wengé, pino vintage y blanco.

The DUROLight tabletops are an ideal option for indoor use due to their resistance, and perfectly combinable with the range of Resol Contract. They are made of melamine with a resin coating on the surface, which protects them from scratches and high temperatures (up to 180°C). The edges are ABS sealed in order to guarantee a perfect and resistant finish. (Tests carried out showed that more than 1.5 Newton is necessary to achieve scratching the surface and 350 rotations in order to show wear.) Available in the colours wenge, vintage pine and white.

La résistance des planches DUROLight en fait l'option idéale pour un usage intérieur, et pouvant être parfaitement combinées avec la gamme de Resol Contract. Ils sont fabriqués en mélamine avec une couche de résine en surface protégeant des rayures et des hautes températures (jusqu'à 180°C) Les bords sont collés par ABS afin de garantir une finition parfaite et résistante. (Les tests réalisés démontrent qu'il faut plus de 1,5 Newton pour parvenir à rayer la surface et 350 rotations pour que l'usure commence.) Couleurs disponibles: wengé, pin vintage et blanc.

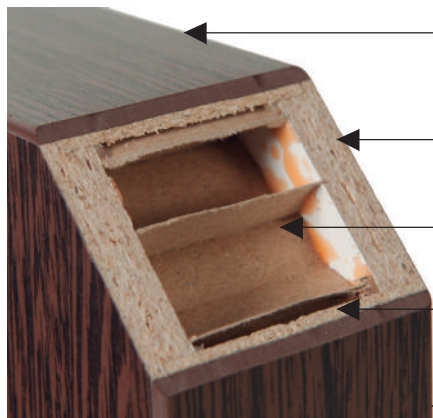

Standard: Acabado de Superficie de Melamina Decorativa + Revestimiento Protector Transparente.  
Standard: Decorative Melamine Surface Finish + Extra Transparent Overlay.  
Standard: Finition de surface de mélamine décorative + revêtement protecteur transparent.

Aglomerado de 8 mm / 8 mm Chipboard layer / Agglomérat de 8 mm.

Núcleo Interno Alveolar / Internal Honeycomb core / Noyau interne alvéolaire

Canto de Unión de 3 mm de ABS inyectado.  
3 mm Support Edge of foamed ABS.  
Bord d'union de 3 mm en ABS injecté.

Canto Decorativo de 2 mm de ABS / 2 mm ABS Decor Edge / Bord décoratif de 2 mm en ABS.

Cualquier otro color bajo pedido y plazo de entrega. Consultar Departamento Comercial.

Any other colour upon request, delivery time varies. Ask the Sales Department.

N'importe quelle couleur sur commande et délai de livraison. Consulter le Département Commercial.

Standard  
Wengé / Wenge / Wengé

L 68 x W 68 x H 5 cm / L 26.77 x W 26.77 x H 1.97 in

L 80 x W 80 x H 5 cm / L 31.49 x W 31.49 x H 1.97 in



Standard  
Blanco / White / Blanc

L 68 x W 68 x H 5 cm / L 26.77 x W 26.77 x H 1.97 in

L 80 x W 80 x H 5 cm / L 31.49 x W 31.49 x H 1.97 in



Standard  
Pino Vintage / Vintage Pine / Pin Vintage

L 68 x W 68 x H 5 cm / L 26.77 x W 26.77 x H 1.97 in

L 80 x W 80 x H 5 cm / L 31.49 x W 31.49 x H 1.97 in



Esquinas redondeadas.  
Rounded corners.  
Coins arrondis.

novedad  
new nouveauté



# Tablero Werzalit®

## Werzalit® table top

### Plateau Werzalit®

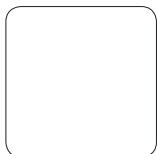

Blanco / White / Blanc

∅ 60 cm / ∅ 23.62 in

**W** 60 x **L** 60 cm / **W** 23.62 x **L** 23.62 in

**L** 70 x **W** 70 cm / **L** 27.56 x **W** 27.56 in

**L** 80 x **W** 80 cm / **L** 31.49 x **W** 31.49 in

**L** 90 x **W** 90 cm / **L** 35.43 x **W** 35.43 in

**L** 120 x **W** 80 cm / **L** 47.24 x **W** 31.49 in

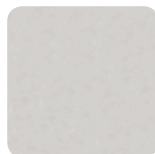

Stratos

∅ 60 cm / ∅ 23.62 in

**L** 70 x **W** 70 cm / **L** 27.56 x **W** 27.56 in

**L** 80 x **W** 80 cm / **L** 31.49 x **W** 31.49 in

**L** 120 x **W** 80 cm / **L** 47.24 x **W** 31.49 in



Arce / Maple / Érable

**L** 70 x **W** 70 cm / **L** 27.56 x **W** 27.56 in

**L** 80 x **W** 80 cm / **L** 31.49 x **W** 31.49 in



Wengé / Wenge / Wengé

∅ 60 cm / ∅ 23.62 in

**L** 70 x **W** 70 cm / **L** 27.56 x **W** 27.56 in

**L** 80 x **W** 80 cm / **L** 31.49 x **W** 31.49 in

**L** 120 x **W** 80 cm / **L** 47.24 x **W** 31.49 in

Los tableros Werzalit se fabrican según un procedimiento patentado especialmente para su uso en interiores y exteriores. Debido al núcleo del material altamente triturado y prensado y con la superficie prensada homogéneamente con materiales derivados de la madera, los tableros Werzalit logran una larga vida útil, son sumamente sólidos y totalmente resistentes a la intemperie. No se recomienda exponer el werzalit en colores oscuros directamente al sol para evitar que se curve o deforme por efecto de la acumulación de calor.

Werzalit table tops are manufactured specially for use inside and outside using a patented procedure. Due to its high density material core manufactured from naturally grown wood and the surface pressed homogeneously with the wood material, Werzalit table tops are durable, hard-wearing and completely weatherproof. We do not recommend to expose dark werzalit table tops to the sun in order to avoid curving or deforming through the effect of heat accumulation.

Les plateaux de tables Werzalit sont fabriqués selon un procédé breveté en particulier pour un usage intérieur comme extérieur. Grâce à son noyau de haute densité avec particules de bois compressées et homogènes, les plateaux de tables Werzalit sont durables, robustes et absolument résistants aux intempéries. Nous recommandons de ne pas exposer les plateaux Werzalit foncés directement au soleil afin d'éviter qu'ils se courbent et se déforment par l'accumulation de chaleur.



Otros colores o medidas, consultar con el departamento comercial / For other colours or sizes please consult commercial department  
/ Plusieurs couleurs, consulter le département commercial.

Cualquier otro color bajo pedido y plazo de entrega. Consultar Departamento Comercial.

Any other colour upon request, delivery time varies. Ask the Sales Department.

N'importe quelle couleur sur commande et délai de livraison. Consulter le Département Commercial.

# Tablero Compacto Fenólico

## HPL table top

## Plateau Résine Phénolique

Cualquier otro color bajo pedido y plazo de entrega. Consultar Departamento Comercial.

Any other colour upon request, delivery time varies. Ask the Sales Department.

N'importe quelle couleur sur commande et délai de livraison. Consulter le Département Commercial.

El compacto fenólico es un laminado de alta presión (HPL). Su composición consiste en capas de papel aglutinado con resinas termoestables de melamina-formaldehído en su superficie y de fenol-formaldehído en su interior. Todo ello es prensado a alta presión ( $\geq 7$  MPa) y alta temperatura ( $\geq 120^{\circ}$  C), dando como resultado uno de los materiales más versátiles por su apariencia, estética, resistencia y durabilidad.

Su extraordinaria superficie está constituida por una hoja impregnada con resina de melamina-formaldehído, que es la que aporta el diseño. Por encima de este diseño decorativo lleva una hoja adicional (overlay), impregnada también en resina melamínica, que le aporta gran resistencia al rayado y la abrasión. Finalmente, el núcleo central, compuesto de papel kraft impregnado en resina fenólica, le dotan de gran resistencia al impacto. Tanto el overlay como el núcleo central de resina fenólica, son los dos elementos diferenciadores del laminado HPL.

El laminado HPL posee la cualidad de ser resistente al calor, al rayado, a la abrasión, impermeable e inerte debido a su superficie no porosa, lo cual lo hace apto para uso interior y exterior e ideal para uso contract.

HPL is a high pressure laminate (HPL). Its composition is bonded paper layers with thermosetting resins, melamine-formaldehyde on its surface and phenol-formaldehyde inside. All this is pressed at high pressure ( $\geq 7$  MPa) and high temperature ( $\geq 120^{\circ}$  C), resulting in one of the most versatile materials in appearance, aesthetics, strength and durability.

Its extraordinary surface is constituted by a sheet impregnated with melamine-formaldehyde resin, which gives it a unique design. Above this decorative design it has an additional sheet (overlay) that's also impregnated with melamine resin, which makes it highly resistant to scratches and abrasion. Finally, the central core, consisting of kraft paper impregnated with phenolic resin, provide it with high impact resistance. Both the overlay and the core of phenolic resin are the two distinguishing features of HPL.

The HPL has the peculiarity of being resistant to heat, scratch, abrasion, waterproof and inert due to its non-porous surface, making it suitable for indoor and outdoor use and ideal for contract use.

La résine phénolique est un stratifié compact (HPL) de haute pression.

Sa composition est constituée de couches de papier avec des résines thermodurcissables, des résines mélamine-formaldéhyde, sur sa surface et de phénol-formaldéhyde à l'intérieur. Tout cela est pressé à haute pression ( $\geq 7$  MPa) et haute température ( $\geq 120^{\circ}$  C), résultant en des matériaux les plus polyvalents pour son apparence, esthétique, solidité et durabilité.

Sa surface extraordinaire est constituée par une feuille imprégnée de résine mélamine-formaldéhyde, qui elle-même apporte son dessin. Au-dessus de ce dessin décoratif, s'ajoute une feuille supplémentaire (overlay) imprégnée de résine mélamine également, ce qui donne une haute résistance aux rayures et l'abrasion. Enfin, le noyau central, composé de papier kraft imprégné de résine phénolique, lui permet une résistance aux chocs élevée. Autant la superposition que le noyau de résine phénolique sont les deux traits distinctifs de HPL.

Le HPL a la qualité d'être résistant à la chaleur, aux égratignures, à l'abrasion, imperméable à l'eau et inerte en raison de sa surface non poreuse, ce qui convient pour usage intérieur et extérieur et idéal pour une utilisation contract.

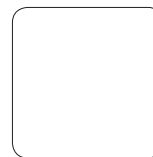

Blanco / White / Blanc



Negro / Black / Noir



Silver

Ø 60 cm x H 1 cm / Ø 23.62 in x H 0.40 in

Ø 70 cm x H 1 cm / Ø 27.56 in x H 0.40 in

Ø 80 cm x H 1 cm / Ø 31.49 in x H 0.40 in

L 60 x W 60 cm x H 1 cm / L 23.62 x W 23.62 in x H 0.40 in

L 70 x W 70 cm x H 1 cm / L 27.56 x W 27.56 in x H 0.40 in

L 80 x W 80 cm x H 1 cm / L 31.49 x W 31.49 in x H 0.40 in

L 90 x W 90 cm x H 1 cm / L 35.43 x W 35.43 in x H 0.40 in

L 120 x W 80 cm x H 1 cm / L 47.24 x W 31.49 in x H 0.40 in

L 180 x W 90 cm x H 1,2 cm / L 70.87 x W 35.43 in x H 0.40 in

L 200 x W 90 cm x H 1 cm / L 78.74 x W 35.43 in x H 0.40 in



# combinaciones de mesas / table combinations / combinaisons de tables



		Roc	Neo	Dalí 40x40	Dalí doble	Dalí ø 40	Dalí 110	Miró 40x40	Miró doble	Miró ø 40
 <b>COMPACTO FENÓLICO</b>	ø 60		✓	✓		✓	✓	✓		✓
	ø 70	✓	✓	✓		✓		✓		✓
	ø 80		✓	✓		✓		✓		✓
	60 x 60		✓	✓				✓		
	70 x 70	✓	✓	✓				✓		
	80 x 80	✓	✓	✓				✓		
	90 x 90									
	120 x 80				✓				✓	
	180 x 90									
	200 x 90									
 <b>WERZALIT</b>	ø 60		✓	✓		✓	✓	✓		✓
	60 x 60		✓	✓				✓		
	70 x 70	✓	✓	✓				✓		
	80 x 80	✓	✓	✓				✓		
	90 x 90									
	120 x 80				✓				✓	
 <b>DUROLIGHT</b>	68 x 68	✓	✓	✓				✓		
	80 x 80	✓	✓	✓				✓		
 <b>INOX REPULSADO</b>	ø 60		✓							
	ø 70		✓							
	60 x 60		✓							
	70 x 70		✓							

Las combinaciones disponibles han sido revisadas y aprobadas por el departamento técnico. Para productos destinados a zonas de alta salinidad consultar previamente con departamento comercial.

The combinations available have been reviewed and approved by the technical department. Ask previously sales dept. for using our products in high salinity areas.

Les combinaisons disponibles ont été examinées et approuvées par le département technique. Produits destinés aux zones de haute salinité consulter à l'avance au dépt. commercial.



		Miró 110	Tàpies	Sisley	Max	Max 120	Max Alto	Raya	Ola
 <b>COMPACTO FENÓLICO</b>	∅ 60	✓	✓	✓	✓		✓		✓
	∅ 70		✓	✓	✓				✓
	∅ 80		✓		✓				✓
	60 x 60		✓	✓	✓			✓	
	70 x 70		✓	✓	✓			✓	
	80 x 80		✓		✓			✓	
	90 x 90								
	120 x 80					✓			
	180 x 90								
	200 x 90								
 <b>WERZALIT</b>	∅ 60	✓		✓	✓		✓		✓
	60 x 60			✓	✓			✓	
	70 x 70			✓	✓			✓	
	80 x 80				✓			✓	
	90 x 90								
	120 x 80					✓			
 <b>DUROLIGHT</b>	68 x 68		✓	✓	✓				
	80 x 80		✓		✓				
 <b>INOX REPULSADO</b>	∅ 60				✓		✓		✓
	∅ 70				✓				✓
	60 x 60				✓			✓	
	70 x 70				✓			✓	
	80 x 80				✓			✓	



sofá lateral / side sofa / canapé latéral

## Clint



Sofá lateral izquierdo / derecho de ratán sintético trenzado en PE plano de 1,4 mm de grosor en color antracita, con estructura de aluminio. Cojín con cremallera desenfundable, de poliéster color negro. Incorpora sistema de enlace entre sofás.

Side left/right sofa in synthetic rattan flat braided in PE of 1.4 mm thickness in anthracite colour with aluminium structure. Removable cushions with zipper in black colour. Clamp connection of sofas included.

Canapé latéral gauche/ droit en osier synthétique tressé en PE plat de 1,4 mm de grosseur en couleur anthracite, avec structure interne en aluminium. Coussin en polyester avec crémaillère déhoussable de couleur noire. Pince de jonction incluse.

**NW** 15,5 Kg (34.17 lb)  
**W** 74 x **L** 137 x **H** 65 cm  
**W** 29.13 x **L** 53.93 x **H** 25.59 in



Antracita  
 Anthracite  
 Anthracite



Cojín negro  
 Cushion black  
 Coussin noir

## Set Clint



Units STD	Packaging Dimensions (cm)	m3/ pack	NW Unit (kg)	Units Container 20'	Units Container 40'	Units Container HC	Units Trayler (70m3)	Units Truck 100m3
1	-	-	61,5	-	27	27	-	-



Antracita  
 Anthracite  
 Anthracite



Cojín negro  
 Cushion black  
 Coussin noir

Otros colores disponibles bajo pedido y plazo de entrega. Consultar Departamento Comercial.

Other colours available upon request, delivery time varies. Ask the Sales Department.

Autres couleurs disponibles sur commande et délai de livraison. Consulter le Département Commercial.

sofá esquina / corner sofa / sofa d'angle

## Clint



Sofá esquina de ratán sintético trenzado en PE plano de 1,4 mm de grosor en color antracita, con estructura de aluminio. Cojín con cremallera desfundable, de poliéster color negro. Incorpora sistema de enlace entre sofás.

Corner sofa in synthetic rattan flat braided in PE of 1.4 mm thickness in anthracite colour with aluminium structure. Removable cushions with zipper, in black colour. Clamp connection of sofas included.

Sofa d'angle en osier synthétique tressé en PE plat de 1,4 mm de grosueur en couleur anthracite, avec structure interne en aluminium. Coussin en polyester avec crémaillère déhoussable de couleur noire. Pince de jonction incluse.

**NW** 10,6 Kg (23.37 lb)

**W** 74 x **L** 74 x **H** 65 cm

**W** 29.13 x **L** 29.13 x **H** 25.59 in



Antracita

Anthracite

Anthracite



Cojín negro

Cushion black

Coussin noir

mesa auxiliar / side table / table auxiliaire

## Clint

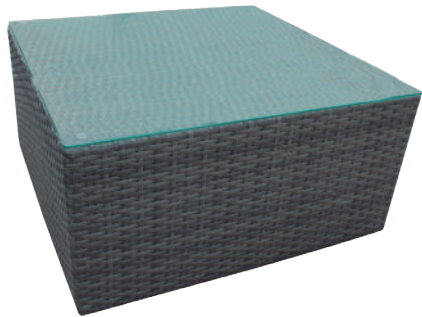

Mesa auxiliar de ratán sintético trenzado en PE plano de 1,4 mm de grosor en color antracita, con estructura de aluminio. Sobre de cristal transparente de 5 mm.

Side table in synthetic rattan flat braided in PE of 1.4 mm thickness in anthracite colour, with aluminium structure. Table top of 5 mm transparent glass.

Table auxiliaire en osier synthétique tressé en PE plat de 1,4 mm de grosueur de couleur anthracite, avec structure interne en aluminium. Plateau en verre transparent de 5 mm.

**NW** 8,9 Kg (19.62 lb)

**L** 65 x **W** 65 x **H** 32 cm

**L** 25.59 x **W** 25.59 x **H** 12.59 in



Antracita

Anthracite

Anthracite

butaca / armchair / fauteuil

## Clint



Butaca de ratán sintético trenzado en PE plano de 1,4 mm de grosor en color antracita, con estructura de aluminio. Cojín con cremallera desfundable, de poliéster color negro.

Armchair in synthetic rattan flat braided in PE of 1.4 mm thickness in anthracite colour with aluminium structure. Removable cushions with zipper, in black colour.

Fauteuil en osier synthétique tressé en PE plat de 1,4 mm de grosueur en couleur anthracite, avec structure interne en aluminium. Coussin en polyester avec crémaillère déhoussable de couleur noire.

**NW** 11 Kg (24.25 lb)

**W** 74 x **L** 74 x **H** 65 cm

**W** 29.13 x **L** 29.13 x **H** 25.59 in



Antracita

Anthracite

Anthracite



Cojín negro

Cushion black

Coussin noir



sofá lateral / side sofa / canapé latéral

## Jack



Sofá lateral izquierdo / derecho de ratán sintético trenzado en PE de 1,4 mm de grosor en color beige, con estructura de aluminio. Cojín con cremallera desenfundable, de poliéster color gris. Incorpora sistema de enlace entre sofás.

Side left/right sofa in synthetic rattan braided in PE of 1.4 mm thickness in beige colour with aluminium structure. Removable cushions with zipper in grey colour. Clamp connection of sofas included.

Sofá latéral gauche/ droit en osier synthétique tressé en PE de 1,4 mm de grosseur de couleur beige, avec structure interne en aluminium. Coussin en polyester avec crémaillère déhoussable de couleur gris. Pince de jonction incluse.

**NW** 10,75 Kg (23.70 lb)  
**W** 80 x **L** 80 x **H** 67 cm  
**W** 31.49 x **L** 31.49 x **H** 26.37 in



Beige  
 Beige  
 Beige



Cojín gris  
 Cushion grey  
 Coussin gris

sofá / sofa / sofa

## Jack



Sofá de ratán sintético trenzado en PE de 1,4 mm de grosor en color beige, con estructura de aluminio. Cojín con cremallera desenfundable, de poliéster color gris. Incorpora sistema de enlace entre sofás.

Sofa in synthetic rattan braided in PE of 1.4 mm thickness in beige colour with aluminium structure. Removable cushions with zipper, in grey colour. Clamp connection of sofas included.

Sofa en osier synthétique tressé en PE de 1,4 mm de grosseur de couleur beige, avec structure interne en aluminium. Coussin en polyester avec crémaillère déhoussable de couleur gris. Pince de jonction incluse.

**NW** 7,5 Kg (16.53 lb)  
**L** 80 x **W** 65 x **H** 67 cm  
**L** 31.49 x **W** 25.59 x **H** 26.37 in



Beige  
 Beige  
 Beige



Cojín gris  
 Cushion grey  
 Coussin gris

## Set Jack



Set Modular.  
 Varias combinaciones posibles.  
 Modular set.  
 Several possible combinations.  
 Set Modular.  
 Plusieurs combinaisons possibles.

Units STD	Packaging Dimensions (cm)	m3/ pack	NW Unit (kg)	Units Container 20'	Units Container 40'	Units Container HC	Units Trayler (70m3)	Units Truck 100m3
1	-	-	73,5	-	20	21	-	-



Beige  
 Beige  
 Beige



Cojín gris  
 Cushion grey  
 Coussin gris

Otros colores disponibles bajo pedido y plazo de entrega. Consultar Departamento Comercial.

Other colours available upon request, delivery time varies. Ask the Sales Department.

Autres couleurs disponibles sur commande et délai de livraison. Consulter le Département Commercial.

sofá esquina / corner sofa / sofa d'angle

## Jack



Sofá esquina de ratán sintético trenzado en PE de 1,4 mm de grosor en color beige, con estructura de aluminio. Cojín con cremallera desenfundable, de poliéster color gris. Incorpora sistema de enlace entre sofás.

Corner sofa in synthetic rattan braided in PE of 1.4 mm thickness in beige colour with aluminium structure. Removable cushions with zipper, in grey colour. Clamp connection of sofas included.

Sofa d'angle en osier synthétique tressé en PE de 1,4 mm de grosueur de couleur beige, avec structure interne en aluminium. Coussin en polyester avec crémaillère déhoussable de couleur gris. Pince de jonction incluse.

**NW** 13 Kg (28.66 lb)  
**W** 155 x **L** 88 x **H** 67 cm  
**W** 61.02 x **L** 34.64 x **H** 26.37 in



Beige  
Beige  
Beige



Cojín gris  
Cushion grey  
Coussin gris

mesa auxiliar / side table / table auxiliaire

## Mesa auxiliar Jack



Mesa auxiliar de ratán sintético trenzado en PE de 1,4 mm de grosor en color beige, con estructura de aluminio. Sobre de cristal transparente de 5 mm.

Side table in synthetic rattan flat braided in PE of 1.4 mm thickness in beige colour, with aluminium structure. Table top of 5 mm transparent glass.

Table auxiliaire en osier synthétique tressé en PE plat de 1,4 mm de grosueur de couleur beige, avec structure interne en aluminium. Plateau en verre transparent de 5 mm.

**NW** 13 Kg (28.66 lb)  
**L** 110 x **W** 65 x **H** 33 cm  
**L** 43.30 x **W** 25.59 x **H** 12.99 in



Beige  
Beige  
Beige

butaca / armchair / fauteuil

## Butaca Jack



Butaca de ratán sintético trenzado en PE de 1,4 mm de grosor en color beige, con estructura de aluminio. Cojín con cremallera desenfundable, de poliéster color gris.

Armchair in synthetic rattan braided in PE of 1.4 mm thickness in beige colour with aluminium structure. Removable cushions with zipper, in grey colour.

Fauteuil en osier synthétique tressé en PE de 1,4 mm de grosueur de couleur beige, avec structure interne en aluminium. Coussin en polyester avec crémaillère déhoussable de couleur gris.

**NW** 11 Kg (24.25 lb)  
**W** 86 x **L** 82 x **H** 67 cm  
**W** 33.85 x **L** 32.28 x **H** 26.37 in



Beige  
Beige  
Beige



Cojín gris  
Cushion grey  
Coussin gris



sofá lateral / side sofa / canapé latéral

## Humphrey



Sofá lateral izquierdo / derecho de ratán sintético trenzado en PE de 1,4 mm de grosor en color chocolate, con estructura de aluminio. Cojín con cremallera desenfundable, de poliéster color beige pardo. Incorpora sistema de enlace entre sofás. El Set Humphrey ofrece la posibilidad de almacenar los cojines en su interior.

Side left/right sofa in synthetic rattan braided in PE of 1.4 mm thickness in chocolate colour with aluminium structure. Removable cushions with zipper in brown beige colour. Clamp connection of sofas included. Humphrey Set allows the storage of the cushions inside.

Sofa latéral gauche/ droit en osier synthétique tressé en PE de 1,4 mm de grosueur en couleur chocolat, avec structure interne en aluminium. Coussin en polyester avec crémaillère déhoussable de couleur beige foncé. Pince de jonction incluse. Set Humphrey offre la possibilité de garder les coussins à l'intérieur.

**NW** 16 Kg (35.27 lb)  
**W** 74 x **L** 137 x **H** 64 cm  
**W** 29.13 x **L** 53.93 x **H** 25.19 in



Chocolate  
 Chocolate  
 Chocolat



Cojín beige pardo  
 Cushion brown beige  
 Coussin beige foncé

## Set Humphrey



Set Modular.  
 Varias combinaciones posibles.  
 Modular set.  
 Several possible combinations.  
 Set Modular.  
 Plusieurs combinaisons possibles.

RESOL Contract

Units STD	Packaging Dimensions (cm)	m3/ pack	NW Unit (kg)	Units Container 20'	Units Container 40'	Units Container HC	Units Trayler (70m3)	Units Truck 100m3
1	-	-	72	-	23	23	-	-



Chocolate  
 Chocolate  
 Chocolat



Cojín beige pardo  
 Cushion brown beige  
 Coussin beige foncé

Otros colores disponibles bajo pedido y plazo de entrega. Consultar Departamento Comercial.

Other colours available upon request, delivery time varies. Ask the Sales Department.

Autres couleurs disponibles sur commande et délai de livraison. Consulter le Département Commercial.



El Set Humphrey ofrece la posibilidad de almacenar los cojines en su interior.

Humphrey Set allows the storage of the cushions inside.

Set Humphrey offre la possibilité de garder les coussins à l'intérieur.

sofá / sofa / sofa

## Humphrey



Sofá de ratán sintético trenzado en PE de 1,4 mm de grosor en color chocolate, con estructura de aluminio. Cojín con cremallera desfundable, de poliéster color beige pardo. Incorpora sistema de enlace entre sofás. El Set Humphrey ofrece la posibilidad de almacenar los cojines en su interior.

Sofa in synthetic rattan braided in PE of 1.4 mm thickness in chocolate colour with aluminium structure. Removable cushions with zipper, in brown beige colour. Clamp connection of sofas included. Humphrey Set allows the storage of the cushions inside.

Sofa en osier synthétique tressé en PE de 1,4 mm de grosueur en couleur chocolat, avec structure interne en aluminium. Coussin en polyester avec crémaillère déhoussable de couleur beige foncé. Pince de jonction incluse. Set Humphrey offre la possibilité de garder les coussins à l'intérieur.

**NW** 7,4 Kg (16.31 lb)

**W** 65 x **L** 74 x **H** 64 cm

**W** 25.59 x **L** 29.13 x **H** 25.19 in



Chocolate

Chocolate

Chocolat



Cojín beige pardo

Cushion brown beige

Coussin beige foncé

sofá esquina / corner sofa / sofa d'angle

## Humphrey



Sofá esquina de ratán sintético trenzado en PE de 1,4 mm de grosor en color chocolate, con estructura de aluminio. Cojín con cremallera desfundable, de poliéster color beige pardo. Incorpora sistema de enlace entre sofás. El Set Humphrey ofrece la posibilidad de almacenar los cojines en su interior.

Corner sofa in synthetic rattan braided in PE of 1.4 mm thickness in chocolate colour with aluminium structure. Removable cushions with zipper, in brown beige colour. Clamp connection of sofas included. Humphrey Set allows the storage of the cushions inside.

Sofa d'angle en osier synthétique tressé en PE de 1,4 mm de grosueur en couleur chocolat, avec structure interne en aluminium. Coussin en polyester avec crémaillère déhoussable de couleur beige foncé. Pince de jonction incluse. Set Humphrey offre la possibilité de garder les coussins à l'intérieur.

**NW** 20 Kg (44.09 lb)

**L** 113 x **W** 113 x **H** 64 cm

**L** 44.48 x **W** 44.48 x **H** 25.19 in



Chocolate

Chocolate

Chocolat



Cojín beige pardo

Cushion brown beige

Coussin beige foncé

mesa auxiliar / side table / table auxiliaire

## Humphrey

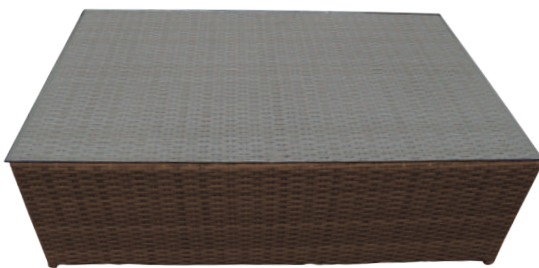

Mesa auxiliar de ratán sintético trenzado en PE de 1,4 mm de grosor en color chocolate, con estructura de aluminio. Sobre de cristal transparente de 5 mm.

Side table in synthetic rattan flat braided in PE of 1.4 mm thickness in chocolate colour, with aluminium structure. Table top of 5 mm transparent glass.

Table auxiliaire en osier synthétique tressé en PE plat de 1,4 mm de grosueur de couleur chocolat, avec structure interne en aluminium. Plateau en verre transparent de 5 mm.

**NW** 12,6 Kg (27.78 lb)

**W** 104 x **L** 65 x **H** 35 cm

**W** 40.94 x **L** 25.59 x **H** 13.78 in



Chocolate

Chocolate

Chocolat



sofá / sofa / sofa

## Bruno



Sofá de ratán sintético redondo en color marrón con estructura interna de aluminio. Cojines desenfundables, con cremallera, en poliéster color gris oscuro.

Synthetic round rattan sofa in brown colour with internal aluminium structure. Removable cushions with zipper in polyester of dark grey colour.

Fauteuil en ronds osier synthétique couleur marron avec structure interne en aluminium. Coussin en polyester avec crémaillère déhoussable de couleur gris foncé.

Units STD	Packaging Dimensions (cm)	m3/ pack	NW Unit (kg)	Units Container 20'	Units Container 40'	Units Container HC	Units Traylor (70m3)	Units Truck 100m3
1	160x88x68	0,96	24	24	53	53	48	72

**L** 153 x **W** 86 x **H** 63,5 cm  
**L** 60.23 x **W** 33.85 x **H** 25 in



Chocolate  
Chocolate  
Chocolat



Cojin gris oscuro  
Cushion dark grey  
Coussins gris foncé

mesa auxiliar / side table / table auxiliaire

## Bruno



Mesa auxiliar de ratán sintético redondo en color marrón con estructura interna de aluminio. Sobre de cristal templado transparente de 5 mm.

Synthetic round rattan side table in brown colour with internal aluminium frame. Table top of 5 mm transparent tempered glass.

Table auxiliaire en ronds rattan synthétique, couleur gris anthracite avec structure en aluminium. Plateau en verre trempé transparent de 5 mm.

Units STD	Packaging Dimensions (cm)	m3/ pack	NW Unit (kg)	Units Container 20'	Units Container 40'	Units Container HC	Units Traylor (70m3)	Units Truck 100m3
1	102x52x43	0,23	12,70	108	225	225	260	348

**L** 100 x **W** 50 x **H** 40 cm  
**L** 39.37 x **W** 19.68 x **H** 15.74 in



Chocolate  
Chocolate  
Chocolat

butaca / armchair / fauteuil

# Bruno



Butaca de ratán sintético redondo en color marrón con estructura interna de aluminio. Cojines desenfundables, con cremallera, en poliéster color gris oscuro.

Synthetic round rattan armchair in brown colour with internal aluminium structure. Removable cushions with zipper in polyester of dark grey colour.

Fauteuil en ronds osier synthétique couleur marron avec structure interne en aluminium. Coussin en polyester avec crémaillère déhoussable de couleur gris foncé.

Units STD	Packaging Dimensions (cm)	m3/ pack	NW Unit (kg)	Units Container 20'	Units Container 40'	Units Container HC	Units Trayler (70m3)	Units Truck 100m3
2	110x115x85	1,07	15,60	56	112	124	96	156

**L** 95,5 x **W** 86 x **H** 63,5 cm  
**L** 37.60 x **W** 33.86 x **H** 25 in



Chocolate  
 Chocolate  
 Chocolat



Cojín gris oscuro  
 Cushion dark grey  
 Coussins gris foncé

**W:** ancho / width / largeur    **L:** largo / length / longueur    **H:** altura / height / hauteur

Otros colores disponibles bajo pedido y plazo de entrega. Consultar Departamento Comercial.

Other colours available upon request, delivery time varies. Ask the Sales Department.

Autres couleurs disponibles sur commande et délai de livraison. Consulter le Département Commercial.





# Set Dream

Resol presenta el exclusivo Set Dream, fruto de la innovación de ofrecer un acabado interior de gran calidad pensado para ambientes exteriores.

Resol presents the exclusive Dream Set, fruit of the innovation of offering a high-quality indoor finishing thought for outdoor environments.

Resol présente l'exclusif Set Dream, comme résultat de l'innovation d'offrir une finition d'haute qualité d'intérieur pensée pour environnements extérieurs.



Units STD	Packaging Dimensions (cm)	m3/ pack	NW Unit (kg)	Units Container 20'	Units Container 40'	Units Container HC	Units Traylor (70m3)	Units Truck 100m3
1	-	-	80	9	19	22	-	-



Blanco  
White  
Blanc



Gris claro  
Light grey  
Gris clair





**Recomendaciones de uso**  
**Recommendations for use**  
**Recommandations d'usage**

Fácil  
mantenimiento.  
Easy to maintain.  
Facile à entretenir.

Producto para uso público y doméstico. Colocar de manera estable sobre suelo plano. No limpiar a alta presión, no utilizar productos de limpieza agresivos, tales como líquidos agresivos, alcohol, limpiacristales, estropajos, etc. Limpiar la superficie con un paño seco o agua jabonosa. Guardar en un espacio limpio y seco.

Product meant for public and domestic use. Place on a flat floor surface, making sure it is stable. Do not clean under high pressure. Do not use aggressive cleaning products, such as abrasive liquids, alcohol, glass-cleaners, scouring pads, etc. Clean the surface with a dry cloth or soapy water. Store in a clean and dry area.

Produit pour l'usage public et domestique. Poser de manière stable sur un sol nivelé. Ne pas nettoyer sous haute pression. Ne pas utiliser de produits nettoyants agressifs tels que des détergents abrasifs, de l'alcool, un produit nettoyant pour les vitres, de la paille de fer, etc. Nettoyer la surface avec un chiffon sec et de l'eau savonneuse. Conserver dans un endroit propre et sec.





sofá lateral / side sofa / canapé latéral

## Dream



Sofá lateral izquierdo / derecho con estructura de aluminio y tapizado en un tejido técnico de alta calidad 100% poliéster, con un revestimiento de poliuretano base agua que lo convierte en una solución ideal para ambientes de exterior. Disponible en color blanco y gris claro. La estructura de aluminio nos permite ofrecer un producto ligero, resistente y apto para exterior. Además cuenta con cavidades en su interior que permiten un completo drenaje del agua.

Left / Right side sofa with aluminium structure and upholstered in a high-quality technical fabric 100% polyester, with a non solvent polyurethane coating, which makes it the ideal solution for outdoor environments. Available in white and light grey colours. The aluminium structure offers a light, resistant and outdoor product. Its internal cavities allow a complete water draining.

Canapé latéral droite / gauche avec structure en aluminium et rembourré en tissu technique d'haute qualité 100% polyester, avec un revêtement en polyurethane à base d'eau, qui en fait une solution idéale pour les environnements extérieurs. Disponible en couleur blanc et gris clair. La structure en aluminium permet offrir un produit léger, durable et adapté à un usage extérieur. Dispose des cavités internes qui permettent un complète drainage de l'eau.

**L** 92 x **W** 92 x **H** 88 x **Hs** 47 x **Ha** 71 cm

**L** 36.22 x **W** 36.22 x **H** 34.65 x **Hs** 18.5 x **Ha** 27.95 in



Blanco  
White  
Blanc



Gris claro  
Light grey  
Gris clair

sofá / sofa / sofa

## Dream



Sofá con estructura de aluminio y tapizado en un tejido técnico de alta calidad 100% poliéster, con un revestimiento de poliuretano base agua que lo convierte en una solución ideal para ambientes de exterior. Disponible en color blanco y gris claro. La estructura de aluminio nos permite ofrecer un producto ligero, resistente y apto para exterior. Además cuenta con cavidades en su interior que permiten un completo drenaje del agua.

Sofa with aluminium structure and upholstered in a high-quality technical fabric 100% polyester, with a non solvent polyurethane coating, which makes it the ideal solution for outdoor environments. Available in white and light grey colours. The aluminium structure offers a light, resistant and outdoor product. Its internal cavities allow a complete water draining.

Canapé avec structure en aluminium et rembourré en tissu technique d'haute qualité 100% polyester, avec un revêtement en polyurethane à base d'eau, qui en fait une solution idéale pour les environnements extérieurs. Disponible en couleur blanc et gris clair. La structure en aluminium permet offrir un produit léger, durable et adapté à un usage extérieur. Dispose des cavités internes qui permettent un complète drainage de l'eau.

**NW** 16 Kg (35.27 lb)

**L** 79 x **W** 92 x **H** 88 x **Hs** 47 cm

**L** 31.10 x **W** 36.22 x **H** 34.65 x **Hs** 18.5 in



Blanco  
White  
Blanc



Gris claro  
Light grey  
Gris clair

sofá esquina / corner sofa / sofa d'angle

## Dream



Sofá esquina con estructura de aluminio y tapizado en un tejido técnico de alta calidad 100% poliéster, con un revestimiento de poliuretano base agua que lo convierte en una solución ideal para ambientes de exterior. Disponible en color blanco y gris claro. La estructura de aluminio nos permite ofrecer un producto ligero, resistente y apto para exterior. Además cuenta con cavidades en su interior que permiten un completo drenaje del agua.

Corner sofa with aluminium structure and upholstered in a high-quality technical fabric 100% polyester, with a non solvent polyurethane coating, which makes it the ideal solution for outdoor environments. Available in white and light grey colours. The aluminium structure offers a light, resistant and outdoor product. Its internal cavities allow a complete water draining.

Sofa d'angle avec structure en aluminium et rembourré en tissu technique d'haute qualité 100% polyester, avec un revêtement en polyurethane à base d'eau, qui en fait une solution idéale pour les environnements extérieurs. Disponible en couleur blanc et gris clair. La structure en aluminium permet offrir un produit léger, durable et adapté à un usage extérieur. Dispose des cavités internes qui permettent un complète drainage de l'eau.

L 92 x W 92 x H 88 x Hs 71 cm  
L 36.22 x W 36.22 x H 34.65 x Hs 27.95 in



Blanco  
White  
Blanc



Gris claro  
Light grey  
Gris clair

mesa reposapiés / table-footrest / table repose-pied

## Dream



Mesa reposapiés con estructura de aluminio y tapizado en un tejido técnico de alta calidad 100% poliéster, con un revestimiento de poliuretano base agua que lo convierte en una solución ideal para ambientes de exterior. Disponible en color blanco y gris claro. La estructura de aluminio nos permite ofrecer un producto ligero, resistente y apto para exterior. Además cuenta con cavidades en su interior que permiten un completo drenaje del agua.

Table-footrest with aluminium structure and upholstered in a high-quality technical fabric 100% polyester, with a non solvent polyurethane coating, which makes it the ideal solution for outdoor environments. Available in white and light grey colours. The aluminium structure offers a light, resistant and outdoor product. Its internal cavities allow a complete water draining.

Table repose-pied avec structure en aluminium et rembourrée en tissu technique d'haute qualité 100% polyester, avec un revêtement en polyurethane à base d'eau, qui en fait une solution idéale pour les environnements extérieurs. Disponible en couleur blanc et gris clair. La structure en aluminium permet offrir un produit léger, durable et adapté à un usage extérieur. Dispose des cavités internes qui permettent un complète drainage de l'eau.

L 82 x W 66 x H 49 cm  
L 32.28 x W 25.98 x H 19.29 in



Blanco  
White  
Blanc



Gris claro  
Light grey  
Gris clair



tumbona / sunlounger / chaise longue

## Cubic Textilene



BS EN 581-1: 2006 Contract Use.  
BS EN 581-2: 2009 Contract Use.

Tumbona de aluminio pintado por pulverización en color gris claro y Textilene de color negro. Embellecedor de madera ultratech. Ruedas de 22 cm., de aluminio cubiertas de goma. Peso neto: 10,20 kg. 5 posiciones.

Powder-coated aluminium sunlounger in light grey and Textilene in black. Trimming of ultratech wood. 22 cm wheels of rubber covered aluminium. Net weight: 10,20 kg (22.44 lb). 5 positions.

Chaise longue en aluminium peint par pulvérisation de couleur gris clair et Textilène noir. Revêtement en bois ultratech. Roues de 22 cm. en aluminium recouvertes de gomme. Poids net: 10,20 kg. 5 positions.

Units STD	Packaging Dimensions (cm)	m <sup>3</sup> / pack	NW Unit (kg)	Units Container 20'	Units Container 40'	Units Container HC	Units Trayler (70m <sup>3</sup> )	Units Truck 100m <sup>3</sup>
2	194x76x37	0,54	10,2	108	216	242	261	372



Negro  
Black  
Noir

**W** 64 x **L** 192 x **H** 83 x **Hs** 34 cm

**W** 25.20 x **L** 75.59 **H** 32.68 x **Hs** 13.38 in

**W:** ancho / width / largeur    **L:** largo / length / longueur    **H:** altura respaldo / back height / hauteur du dossier    **Hs:** altura asiento / seat height / hauteur du siège





tumbona / sunlounger / chaise longue

## Shio Textilene



BS EN 581-1: 2006 Contract Use.  
BS EN 581-2: 2009 Contract Use.

Tumbona de aluminio pintado por pulverización en color blanco y Textilene de color blanco. Embellecedor de madera ultratech. Ruedas de 22 cm, de aluminio cubiertas de goma. Peso neto: 10,20 kg. 5 posiciones.

Powder-coated aluminium sunlounger in white and Textilene in white. Trimming of ultratech wood. 22 cm wheels of rubber covered aluminium. Net weight: 10,20 kg (22.44 lb). 5 positions.

Chaise longue en aluminium peint par pulvérisation de couleur blanche et Textilène blanc. Revêtement en ultratech. Roues de 22 cm. en aluminium recouvertes de gomme. Poids net: 10,20 kg. 5 positions.

Units STD	Packaging Dimensions (cm)	m3/ pack	NW Unit (kg)	Units Container 20'	Units Container 40'	Units Container HC	Units Trayler (70m3)	Units Truck 100m3
2	194x76x37	0,54	10,2	108	216	242	260	372



Blanco  
White  
Blanc

**W** 64 x **L** 192 x **H** 83 x **Hs** 34 cm

**W** 25.20 x **L** 75.59 **H** 32.68 x **Hs** 13.38 in

tumbona / sunlounger / chaise longue

## Comfort



Tumbona apilable de aluminio pintado por pulverización en gris oscuro con textilene gris claro. Peso neto: 8,70 kg. Reclinable en 6 posiciones.

Power-coated aluminium stackable sunlounger in dark grey. Light grey textilene. Net weight: 8,70 kg (19.14 lb). Six-position reclining sunlounger.

Chaise longue empilable en aluminium peint par pulvérisation couleur gris foncé. Poids net: 8,70 kg. 6 positions de dossier.

Units STD	Packaging Dimensions (cm)	m3/ pack	NW Unit (kg)	Units Container 20'	Units Container 40'	Units Container HC	Units Trayler (70m3)	Units Truck 100m3
25	205x68x213	3,09	8,7	184	391	391	437	506



Gris  
Grey  
Gris

**W** 65 x **L** 193 x **H** 86 x **Hs** 34 cm

**W** 25.59 x **L** 75.98 x **H** 33.85 x **Hs** 13.38 in

**W:** ancho / width / largeur    **L:** largo / length / longueur    **H:** altura respaldo / back height / hauteur du dossier    **Hs:** altura asiento / seat height / hauteur du siège





tumbona / sunlounger / chaise longue

## Marina



Tumbona apilable con estructura de polipropileno y fibra de vidrio en color blanco. Textilene de 1170 gr/m<sup>2</sup>, termosoldado, para mayor resistencia, y trama y urdimbre de doble hilo. Protección UV. Ruedas en patas traseras y tacos antideslizantes en las delanteras y traseras. Incorpora posavasos. Peso neto 10,65 kg. Reclinable en 4 posiciones.

Stackable sunlounger. Polypropylene and fiberglass White frame. Textilene 1170 gr/m<sup>2</sup>, thermal bonding, to improve resistance, double linen weft and warp. UV protection. Wheels under back legs and non-slip end-plates under front and back legs. Glass holder. Net weight: 10.65 kg (23.43 lb). Four-position reclining sunlounger.

Chaise longue empilable avec structure en polypropylène et fibre de verre en couleur blanc. Textilène de 1170 gr/m<sup>2</sup>, termosoudé pour une résistance meilleure, et double chaîne et du fil de trame et ourdir. Pieds arrière munis de roues et pieds avant et arrière munis de patins antidérapants, avec repose-verres. Poids net 10,65 kg. 4 positions du dossier.



**W** 73 x **L** 190 x **H** 35 cm  
**W** 28.74 x **L** 74.80 x **H** 13.77 in

Marina Test Certificates:

AIDIMA EN 15373:07 General Public Use / UNE EN 1728:01  
POURQUERY EN 581-1:1997 / EN 1022:1997 / ENV 581-2:2000 / ENV 581-2 Ed04/00  
MOBELTEST BS 4875-1:2001 / BS EN 1728:2001 / BS EN 1022:1997 Strength and Stability Requirements Domestic and Contract Use.

**W:** ancho / width / largeur    **L:** largo / length / longueur    **H:** altura / height / hauteur

ASOCIADO N°01684  
**AIDIMA**  
INSTITUTO TECNOLÓGICO  
MUEBLE, MADERA, EMBALAJE Y AFINES



tumbona / sunlounger / chaise longue

## Diseño inteligente / Smart design

### Máxima apilabilidad en mínimo espacio (25 unidades)

Maximum Stackability in minimum space (25 units)  
Empilable au maximum dans un espace minimum (25 unités)

### 4 posiciones

**(incluye posición extraplana ideal para estar tumbado boca abajo)**  
Four-position reclining sunlounger (including flat position)  
4 positions du dossier (inclus position extraplate)

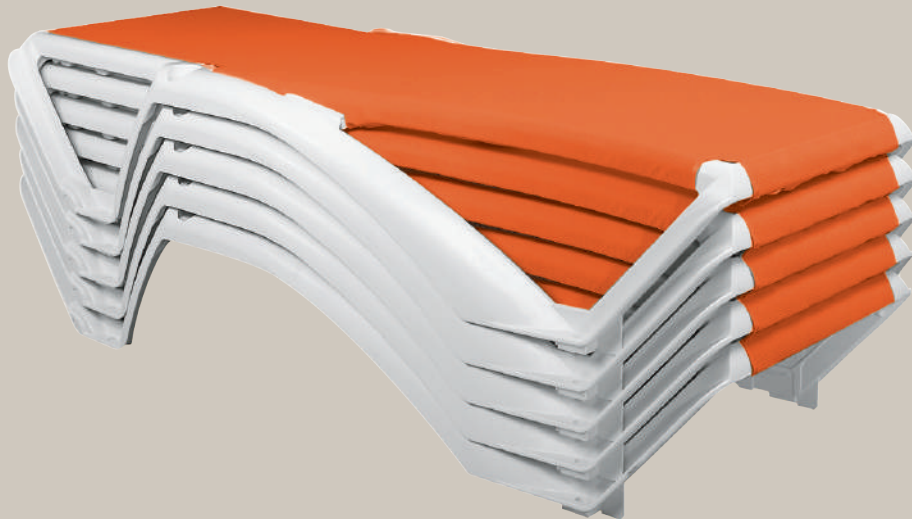

### Tumbona monobloc

Monoblock sunlounger  
Bain de soleil monobloc

### Protección UV

UV protection  
Protection UV

### Extremadamente resistente

Extremely strong  
Résistance extrême

### Ligera

Lightweight  
Légère



### Ruedas en patas traseras

Wheels under back legs  
Pieds arrières avec roulettes



### Tacos antideslizantes en todas las patas

Non-slip end-plates under front and back legs  
Pieds avant et arrière munis de patins antidérapant



### Posavasos

Glass holder  
Support de verre



### Amplia gama de colores

Wide range of colors  
Large plage de couleurs

### Personalizable

Customised logos  
Possibilité de personnalisation

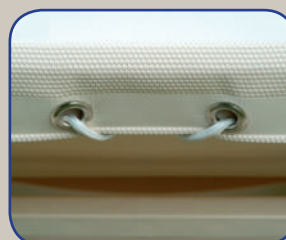

### Textilene sustituible

Replaceable textilene  
Textilene remplaçable

### Elevada tensión del textilene

High tensed textilene  
Grande tension du textilène



Estructura blanca / White frame / Structure blanche



Azul  
Blue  
Bleu



Naranja  
Orange  
Orange



Blanco/Azul  
White/Blue  
Blanc/Bleu



Amarillo  
Yellow  
Jaune



Verde  
Green  
Vert



Crudo  
Natural  
Ecu



Blue Jeans  
Blue Jeans  
Blue Jeans

Estructura nuevo marfil / New Ivory frame / Structure nouvel ivoire



Crudo  
Natural  
Ecu

Estructura gris oscuro / Dark grey frame / Structure gris foncé



Crudo  
Natural  
Ecu

Estructura plata / Silver frame / Structure argent



Blue Jeans  
Blue Jeans  
Blue Jeans

Units STD	Packaging Dimensions (cm)	m3/ pack	NW Unit (kg)	Units Container 20'	Units Container 40'	Units Container HC	Units Trayler (70m3)	Units Truck 100m3
2	191x75x46	0,66	10,65	80	168	208	200	621
25	191x75x222	3,18	10,65	225	450	450	525	625
27	191x75x237	3,40	10,65	-	-	486	567	675

Estructura wengé / wengé trame / Structure wengé



Chocolate  
Chocolate  
Chocolat

Colores textilenes / Textilene colours / Couleurs Textilène



Azul  
Blue  
Bleu

Verde  
Green  
Vert

Naranja  
Orange  
Orange

Amarillo  
Yellow  
Jaune



Blanco/Azul  
White/Blue  
Blanc/Bleu

Blue Jeans  
Blue Jeans  
Blue Jeans

Crudo  
Natural  
Ecrú

Chocolate  
Chocolate  
Chocolat

Colores textilene especiales. Consultar con departamento comercial / Special textilene. Please consult commercial department / Couleurs spéciales. Consulter le département comercial





tumbona / sunlounger / chaise longue

## Costa Brava



Tumbona apilable fija con estructura de polipropileno. Peso neto 8,65 kg. Protección UV.

Stackable sunlounger. Polypropylene frame. Net weight 8.65 kg (19.03 lb). UV Protection.

Chaise longue empilable fixe avec structure de polypropylène. Poids net 8,65 kg. Protection UV.

Units STD	Packaging Dimensions (cm)	m3/ pack	NW Unit (kg)	Units Container 20'	Units Container 40'	Units Container HC	Units Trayler (70m3)	Units Truck 100m3
2	63x185x50	0,58	8,65	306	612	-	-	-
33	70x185x221	2,86	8,65	297	594	-	-	-
36	70x185x236	3,06	8,65	-	-	648	756	-



**W** 63 x **L** 188 x **H** 47 cm  
**W** 24.80 x **L** 74.02 x **H** 18.50 in



Blanco  
White  
Blanc

tumbona / sunlounger / chaise longue

## Master



Tumbona apilable con estructura de polipropileno. Ruedas en patas traseras. Peso neto 10,25 kg. Reclinable 5 posiciones. Protección UV.

Polypropylene frame stackable sunlounger. Wheels under back legs. Net weight 10.25 kg (22.55 lb). Five-position reclining sunlounger. UV Protection.

Chaise longue empilable avec structure de polypropylène. Pieds arrière munis de roues. Poids net 10,25 kg. 5 positions de dossier. Protection UV.

Units STD	Packaging Dimensions (cm)	m3/ pack	NW Unit (kg)	Units Container 20'	Units Container 40'	Units Container HC	Units Trayler (70m3)	Units Truck 100m3
2	63x185x50	0,58	10,25	306	612	-	-	-
33	70x185x221	2,86	10,25	297	627	627	693	825
36	70x185x236	3,06	10,25	-	-	684	756	900



**W** 63 x **L** 188 x **H** 47 cm  
**W** 24.80 x **L** 74.02 x **H** 18.50 in



Blanco  
White  
Blanc



Verde oscuro  
Dark green  
Vert foncé





mesa auxiliar / side table / table auxiliaire

## Andorra



Mesa auxiliar de polipropileno, con protección U.V. Patas embutidas. Peso neto 2,14 kg.  
Polypropylene side table. UV protection. Pressure-fitted legs. Net weight 2.14 kg (4.708 lb).  
Table auxiliaire en polypropylène avec protection U.V. Pieds emboîtés. Poids net 2,14 kg.

Units STD	Packaging Dimensions (cm)	m3/ pack	NW Unit (kg)	Units Container 20'	Units Container 40'	Units Container HC	Units Trayler (70m3)	Units Truck 100m3
6	48x48x52	0,12	2,14	1.320	2.640	3.300	3.696	
120	120x100x215	2,58	2,14		2.400			
136	120x100x235	2,82	2,14				3.536	

**W** 47 x **L** 47 x **H** 41 cm  
**W** 18.50 x **L** 18.50 x **H** 16.14 in



Blanco  
White  
Blanc



Verde oscuro  
Dark green  
Vert foncé

mesa auxiliar / side table / table auxiliaire

## Mónaco



Mesa auxiliar monobloc de polipropileno, con protección U.V. Apilable. Peso Neto 1,65 kg.  
Polypropylene monobloc side table. UV protection. Stackable. Net weight: 1,65 kg (3,63 lb).  
Table auxiliaire monobloc en polypropylène avec protection U.V. Empilable. Poids net: 1,65 kg.

Units STD	Packaging Dimensions (cm)	m3/ pack	NW Unit (kg)	Units Container 20'	Units Container 40'	Units Container HC	Units Trayler (70m3)	Units Truck 100m3
5	60x60x63	0,23	1,65	565	1.215	1.430	1.475	2.130
82	80x120x213	2,04	1,65	984	2.214	2.624	2.706	3.936



**L** 50 x **W** 50 x **H** 45 cm  
**L** 19.68 x **W** 19.68 x **H** 17.72 in



Blanco  
White  
Blanc



Verde oscuro  
Dark green  
Vert foncé



Wengé  
Wenge  
Wengé







mesa auxiliar / side table / table auxiliaire

## Shio aluminio



Mesa auxiliar de aluminio pintado por pulverización en color blanco.

Powder-coated aluminium auxiliary table in white.

Table auxiliaire en aluminium peint par pulvérisation de couleur blanc

Units STD	Packaging Dimensions (cm)	m3/ pack	NW Unit (kg)	Units Container 20'	Units Container 40'	Units Container HC	Units Trayler (70m3)	Units Truck 100m3
1	55x55x12	0,03	3,90	1.000	2.000	2.241	2.414	3.448



Blanco

White

Blanc

L 50 x W 50 x H 45 cm

L 19.68 x W 19.68 x H 17.72 in

mesa auxiliar / side table / table auxiliaire

## Cubic aluminio



Mesa auxiliar de aluminio pintado por pulverización en color gris claro.

Powder-coated aluminium auxiliary table in light grey.

Table auxiliaire en aluminium peint par pulvérisation de couleur gris clair.

Units STD	Packaging Dimensions (cm)	m3/ pack	NW Unit (kg)	Units Container 20'	Units Container 40'	Units Container HC	Units Trayler (70m3)	Units Truck 100m3
1	55x55x12	0,03	3,90	1.000	2.000	2.241	2.414	3.448



Gris claro

Light grey

Gris clair

L 50 x W 50 x H 45 cm

L 19.68 x W 19.68 x H 17.72 in

parasol / parasol / parasol

## A2



Base Stone 25



Parasol cuadrado de 4 x 4 m de aluminio pintado por pulverización en color blanco para uso profesional. Mástil estriado de aluminio de una sola pieza de Ø 78 mm. y 2,5 mm de grosor. 8 varillas de aluminio de 22 x 35 mm y 1,5 mm de grosor. Piña y colante de aluminio inyectado. Tela de poliéster de 300 g/m<sup>2</sup>, sin "flap", con chimenea. (Incluye funda con cremallera). Recambio de tela disponible. Incluye base en cruz de aluminio de 98 x 107 cm. Para bases empotrables ver la ref. Base empotrable para A2. No incluye pie.

Square 4 x 4 m powder-coated aluminium parasol in white for professional use. Grooved aluminium pole of one sole piece with Ø 78 mm and a thickness of 2.5 mm. 8 aluminium ribs 22 x 35 mm with a 1.5 mm thickness. Injected aluminium hub and runner. 300 g/m<sup>2</sup> polyester fabric without "flap", with airshaft. (Includes cover with zipper). Fabric replacement available. Includes a 98 x 107 cm aluminium cross base. For bases that can be fitted into the ground, see ref. Base that can be fitted into the ground for A2. Base not included.

Base not included.

Parasol carré de 4 x 4 m en aluminium peint par pulvérisation de couleur blanche pour usage professionnel. Mât strié en aluminium d'une seule pièce de Ø 78 mm. x 2,5 mm. de grosueur. 8 baleines en aluminium de 22 x 35 mm et 1,5 mm de grosueur. Moyeu et tête de mât en aluminium injecté. Tissu en polyester de 300 g/m<sup>2</sup>., sans «flap», avec cheminée. (Inclus housse avec fermeture éclair). Rechange de tissu disponible. Base en forme de croix en aluminium de 98 x 107 cm, incluse. Et pour les bases encastrables, voir la réf. Base encastrable pour A2. Pied non inclus.

Units STD	Packaging Dimensions (cm)	m3/ pack	NW Unit (kg)	Units Container 20'	Units Container 40'	Units Container HC	Units Traylor (70m3)	Units Truck 100m3
1	396x28x26	0,29	31	56	112	125	135	

**W** 410 x **L** 410 x **H** 412 cm  
**W** 161.41 x **L** 161.41 x **H** 162.20 in



Crudo  
Natural  
Ecrú



Crudo  
Natural  
Ecrú

Recambio tela  
Fabric replacement  
Rechange du tissu

base empotrable / fitted base / base encastrable

## A2



Base empotrable de acero galvanizado y con pletina de fijación inoxidable AISI 316 y tapa de aluminio pintado epoxy blanco.

Base of galvanised steel, that can be fitted into the ground, and with an AISI 316 fixing plate and an epoxy painted aluminium lid in white.

Base encastrable en acier galvanisé et platine de fixation inoxydable AISI 316 et couvercle en aluminium peint en époxy blanc.

Units STD	Packaging Dimensions (cm)	m3/ pack	NW Unit (kg)	Units Container 20'	Units Container 40'	Units Container HC	Units Traylor (70m3)	Units Truck 100m3
1	16x16x60	0,02	10	1.400				

**Ø** 7 x **H** 40 cm  
**Ø** 2.76 x **H** 15.75 in



Acero  
Steel  
Acier

**W:** ancho / width / largeur **L:** largo / length / longueur **H:** altura / height / hauteur



parasol / parasol / parasol

## LA2

Parasol de pie lateral de diámetro 3,5 m, 8 varillas de aluminio de 17x25 mm. Mástil de aluminio con apertura por manivela, 6,5x9,5 cm. Tela de poliéster de 250 g/m2, sin "flap", con chimenea. Función de inclinación de la cubierta a derecha e izquierda. Giro con rotación de 360º. No incluye pie.

Powder-coated aluminium lateral umbrella of 3.5 m diameter. Eight ribs 17,25 mm. Aluminium pole 2,56x3.74 in opening with crank, 250 gr/m2 polyester fabric without "flap", with airshaft. Cover tilt, turning left and right. Turning to 360º rotating. Base not included.

Parasol avec pied latéral de diamètre 3,5 m, 8 baleines en aluminium de 17x25 mm. Mât de 6,5x9,5 cm en aluminium avec ouverture par manivelle. Tissu en polyester de 250 gr/m2 sans "flap", avec cheminée. Fonction d'inclinaison du toit à droite et à gauche. Giro 360º de rotation. Pied non inclus.



RESOL Contract

Units STD	Packaging Dimensions (cm)	m3/ pack	NW Unit (kg)	Units Container 20'	Units Container 40'	Units Container HC	Units Traylor (70m3)	Units Truck 100m3
1	45x258x17	0,197	26	130	260	300	350	

∅ 350 x H 245 cm  
∅ 137.80 x H 96.46 in



Taupé  
Taupe  
Taupe



Crudo  
Natural  
Ecrú

parasol / parasol / parasol

# A1

Parasol cuadrado 3 x 3 m. de doble polea. Mástil de aluminio de una sola pieza lacado blanco de  $\varnothing$  58 mm. 8 varillas de aluminio de 18 x 28 mm. Gramaje tela 300 g/m<sup>2</sup>. Poliester. No incluye pie.



Square aluminium parasol 3 x 3 m with double pulley. Single piece white lacquer-coated aluminium pole  $\varnothing$  58 mm. 8 aluminium ribs 18 x 28 mm. Fabric weight 300 g/m<sup>2</sup>. Polyester fiber. Base not included.

Parasol carré 3 x 3 m, double poulie. Mât en aluminium laqué blanc  $\varnothing$  58 mm. 8 baleines aluminium 18 x 28 mm. Grammage de la toile 300 g/m<sup>2</sup>. Polyester. Pied non inclus.





Base Siro 35

Units STD	Packaging Dimensions (cm)	m <sup>3</sup> / pack	NW Unit (kg)	Units Container 20'	Units Container 40'	Units Container HC	Units Traylor (70m <sup>3</sup> )	Units Truck 100m <sup>3</sup>
1	20x20x270	0,087	12,5	316	660	770	792	1.132

-   
 Crudo  
Natural  
Ecu
-   
 Verde  
Green  
Vert
-   
 Burdeos  
Burgundy  
Bordeaux

Recambio tela  
Fabric replacement  
Rechange du tissu

-   
 Crudo  
Natural  
Ecu
-   
 Verde  
Green  
Vert
-   
 Burdeos  
Burgundy  
Bordeaux

**W** 300 x **L** 300 x **H** 270 cm  
**W** 118.11 x **L** 118.11 x **H** 106.30 in

RESOL Contract



parasol / parasol / parasol

11

Parasol cuadrado 3 x 3 m. de doble polea. Mástil de aluminio de una sola pieza  $\phi$  45 mm. 8 varillas de aluminio de 18 x 28 mm. Gramaje tela 300 g/m<sup>2</sup>. Poliester. Aluminio con efecto inox. No incluye pie.

Square aluminium parasol 3 x 3 m with double pulley. Single piece aluminium pole  $\phi$  45 mm. 8 aluminium ribs 18 x 28 mm. Fabric weight 300 g/m<sup>2</sup>. Polyester fiber. Aluminum with stainless steel effect. Base not included.

Parasol carré 3 x 3 m, double poulie. Mât en aluminium  $\phi$  45 mm. 8 baleines aluminium 18 x 28 mm. Grammage de la toile 300 g/m<sup>2</sup>. Polyester. Aluminium avec un effet d'acier inoxydable. Pied non inclus.



Base Siro 35

Units STD	Packaging Dimensions (cm)	m <sup>3</sup> / pack	NW Unit (kg)	Units Container 20'	Units Container 40'	Units Container HC	Units Trayler (70m <sup>3</sup> )	Units Truck 100m <sup>3</sup>
1	20x265x20	0,108	13,5	242	484	572	528	572

**W** 300 x **L** 300 x **H** 260 cm  
**W** 118.11 x **L** 118.11 x **H** 102.36 in

  
Gris oscuro  
Dark grey  
Gris foncé

parasol / parasol / parasol

## AM1

Parasol cuadrado de 3 x 3 m de aluminio y altura 2,70 m. Mástil de 58 mm de diámetro con acabado color madera. 8 varillas de aluminio de 18 x 28 mm y acabado color madera. Tela de poliéster de 300 g/m2 sin "flap" con chimenea. Sistema de polea de plástico.

No incluye pie.

Square aluminium umbrella 3 x 3 m and 2.7 m high. Pole of 58 mm of diameter in wood colour finish. Eight ribs 18 x 28 mm in wood colour finish. 300 g/m2 polyester fabric in without "flap", with airshaft. Plastic pole system.

Base not included.

Parasol carré de 3 x 3 m en aluminium et hauteur 2,70 m. Mât de 58 mm de diamètre avec finition couleur bois. 8 baleines en aluminium de 18 x 28 mm et finition couleur bois. Tissu en polyester de 300 g/m2 couleur "flap" avec cheminée. Système de poulie en matière plastique.

Pied non inclus.



Mástil de aluminio con acabado color madera.

Aluminium pole in wood color finish.

Mât en aluminium avec finition couleur bois.

Units STD	Packaging Dimensions (cm)	m3/ pack	NW Unit (kg)	Units Container 20'	Units Container 40'	Units Container HC	Units Trayler (70m3)	Units Truck 100m3
1	20x20x270	0,108	13,5	242	484	572	528	572

**W** 300 x **L** 300 x **H** 270 cm

**W** 118.11 x **L** 118.11 x **H** 106.30 in



Taupé

Taupe

Taupe



parasol / parasol / parasol

## M2

Parasol redondo de  $\phi$  3 m con doble polea. Mástil de madera tropical barnizada de dos piezas de  $\phi$  48 mm. 8 varillas de madera de 17x 22 mm. Gramaje tela 270 g/m<sup>2</sup>. Poliester. No incluye pie.

Round parasol,  $\phi$  3 m with double pulley and two-piece hardwood varnished pole  $\phi$  48 mm. 8 wooden ribs 17 x 22 mm. Fabric weight 270 g/m<sup>2</sup>. Polyester fiber. Base not included.

Parasol rond  $\phi$  3 m, double poulie. Mât bois vernis, deux pièces  $\phi$  48 mm. 8 baleines bois 17 x 22 mm. Grammage de la toile 270 g/m<sup>2</sup>. Polyester. Pied non inclus.



Base Siro 35

RESOL Contract

Units STD	Packaging Dimensions (cm)	m <sup>3</sup> / pack	NW Unit (kg)	Units Container 20'	Units Container 40'	Units Container HC	Units Trayler (70m <sup>3</sup> )	Units Truck 100m <sup>3</sup>
1	15x158x15	0,04	6,50	800	1.600	1.900	1.955	2.794

$\phi$  300 x H 270 cm  
 $\phi$  118.11 x H 106.30 in



Crudo  
Natural  
Ecru



Verde oscuro  
Dark green  
Vert force

parasol / parasol / parasol

# A3

Parasol cuadrado 2 x 2 m, de doble polea. Mástil de aluminio de una sola pieza lacado blanco de Ø 48 mm. 8 varillas de aluminio de 18 x 28 mm. Gramaje de la tela 300 g/m3. Poliéster. No incluye pie. Peso neto 4,50 kg.

Square aluminium parasol 2 x 2 m, with double pulley. Single piece white lacquer-coated aluminium pole Ø 48 mm. 8 aluminium ribs 18 x 28 mm. Fabric weight 300 g/m3. Polyester fiber. Base not included. Net weight 4,50 kg (9.92 lb).

Parasol carré 2 x 2 m, double pule. Mât aluminium laqué blanc Ø 48 mm. 8 baleines en aluminium 18 x 28 mm. Grammage de la toile 300 g/m3. Polyester. N'inclut pas le pied. Poids net 4,50 kg.



Base Siro 35

RESOL Contract

Units STD	Packaging Dimensions (cm)	m3/ pack	NW Unit (kg)	Units Container 20'	Units Container 40'	Units Container HC	Units Traylor (70m3)	Units Truck 100m3
1	15x15x15	0,03	4,50	-	1.670	-	-	-

**W** 200 x **L** 200 x **H** 240 cm  
**W** 78.74 x **L** 78.74 x **H** 94.49 in



Crudo  
 Natural  
 Ecu



parasol / parasol / parasol

## One push

Parasol cuadrado 2,5 x 2,5 m, de doble polea. Mástil de aluminio de dos piezas lacado blanco de Ø 48 mm. 8 varillas de aluminio de 12 x 18 mm. Gramaje de la tela 180 g/m<sup>3</sup>, en poliéster. No incluye pie. Peso neto 9 kg. Sistema de apertura muy fácil mediante muelle de alta resistencia.

Square aluminium parasol 2,5 x 2,5 m, with double pulley. Two-pieces white lacquer-coated aluminium pole Ø 48 mm. 8 aluminium ribs 12 x 18 mm. Fabric weight 180 g/m<sup>3</sup>, in polyester. Base not included. Net weight 9 kg (19.84 lb). Very easy opening system with high strength spring.

Parasol carré 2,5 x 2,5 m, double pule. Mât en deux pièces aluminium laqué blanc Ø 48 mm. 8 baleines en aluminium 12 x 18 mm. Grammage de la toile 180 g/m<sup>3</sup>, en polyester. N'inclut pas le pied. Poids net 9 kg. Système d'ouverture très facile avec ressort d'haute résistance.



Flexo 35

RESOL Contract

Units STD	Packaging Dimensions (cm)	m <sup>3</sup> / pack	NW Unit (kg)	Units Container 20'	Units Container 40'	Units Container HC	Units Traylor (70m <sup>3</sup> )	Units Truck 100m <sup>3</sup>
1	178x17,2x17,2	0,05	-	533	1.092	-	-	-

**W** 250 x **L** 250 x **H** 240 cm  
**W** 98.42 x **L** 98.42 x **H** 94.49 in

Crudo  
Natural  
Ecrú

pie rellenable / refillable base / pied remplissable

## Strong 150



Cuando está relleno de arena o agua su peso es de 120 kg. Pie apto para parasoles A2 y LA2. Para cambiar el pie de ubicación con el parasol instalado se recomienda no realizar la maniobra de forma brusca para evitar que las ruedas se rompan.

When it's full of sand or water, its weight is 264,55 lb. Base fit for A2 and LA2 parasols. To move the base with parasol installed it is recommended not to perform the maneuver abruptly to prevent wheels breakage.

Lorsqu'il est rempli avec du sable ou de l'eau, son poids est de 120 kg. Pied compatible pour parasols A2 et LA2. Pour changer l'emplacement du parasol installé, il est recommandé de ne pas effectuer la manœuvre brusquement afin d'éviter la rupture des roues.

Units STD	Packaging Dimensions (cm)	m3/ pack	NW Unit (kg)	Units Container 20'	Units Container 40'	Units Container HC	Units Trayler (70m3)	Units Truck 100m3
1	86x86x21	0,15	16	172	368	435	-	-



Negro  
Black  
Noir

**W** 84 x **L** 84 x **H** 18 cm

**W** 33,07 x **L** 33,07 x **H** 7,09 cm

peso / block / poid

## Stone 25



Peso de cemento negro de 25 kg para base en cruz de parasol.

25 kg (55lb) cement black block for cross-type parasol base.

Poids noir de ciment de 25 kg pour base de parasol en forme de croix.

Units STD	Packaging Dimensions (cm)	m3/ pack	NW Unit (kg)	Units Container 20'	Units Container 40'	Units Container HC	Units Trayler (70m3)	Units Truck 100m3
1	50x50x8,5	0,13	26,43	162	378	420	464	480



Negro  
Black  
Noir

**W** 47 x **L** 47 x **H** 5,5 cm

**W** 18.5 x **L** 18.5 x **H** 2.17 in

pie / base / pied

## Siro 35



Pie de parasol negro de 35 kg. Base de cemento con estructura de acero y caucho con ruedas. Base de diámetro 50 cm. Apto para mástiles Ø 38 mm, Ø 48 mm y Ø 58 mm.

Black parasol base 35 kg (77.00 lb). Concrete base with steel structure and protective rubber ring with wheels. Base diameter 50 cm. Suitable for Ø 38 mm, Ø 48 mm and Ø 58 mm poles.

Pied de parasol noir de 35 kg. Base en ciment avec structure en Asier et anneau de protection en caoutchouc avec roues. Embase de 50 cm de diamètre. Pour mâts de Ø 38 mm, Ø 48 mm et Ø 58 mm.

Units STD	Packaging Dimensions (cm)	m3/ pack	NW Unit (kg)	Units Container 20'	Units Container 40'	Units Container HC	Units Trayler (70m3)	Units Truck 100m3
1	57x16x60	0,05	35	488				



Negro  
Black  
Noir

**Ø** 50 x **H** 60 cm

**Ø** 19.69 x **H** 23.62 in



pie /base / pied

## Siro 15



Pie de parasol negro de 15 kg. Base de cemento con estructura de acero y aro de caucho protector. Base de diámetro de 48 cm. Apto para mástiles de  $\varnothing$  30 mm,  $\varnothing$  35 mm y  $\varnothing$  38 mm.

Black parasol base 15 kg (33.00 lb)  $\varnothing$  48 concrete base with steel structure and protective rubber ring. Base diameter 48 cm. Suitable for  $\varnothing$  30 mm,  $\varnothing$  35 mm and  $\varnothing$  38 mm poles.

Pied de parasol noir de 15 kg. Embase en ciment avec structure en acier et anneau de protection en caoutchouc. Embase de 48 cm de diamètre. Pour mâts de  $\varnothing$  30 mm,  $\varnothing$  35 mm et  $\varnothing$  38 mm.

Units STD	Packaging Dimensions (cm)	m3/ pack	NW Unit (kg)	Units Container 20'	Units Container 40'	Units Container HC	Units Trayler (70m3)	Units Truck 100m3
1	54x48x11	0,03	15	900				



Negro  
Black  
Noir

$\varnothing$  41,5 x H 60 cm

$\varnothing$  16.35 x H 23.62 in

pie /base / pied

## Flexo 35

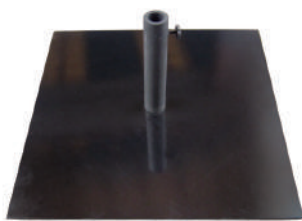

Nuevo pie de hierro de 35 kg. Con agujeros para sujeción en el suelo. Adaptable para todos los modelos de parasol. Diámetro igual que el Siro 35, apto para parasoles de  $\varnothing$  38,  $\varnothing$  48 y  $\varnothing$  58.

New iron base 35 kg (77.16 lb). With fastening holes to fix on the ground. Suitable for all models of parasol. Same diameter than Siro 35, for  $\varnothing$  38,  $\varnothing$  48 and  $\varnothing$  58 parasols.

Nouveau pied en fer 35 kg. Avec trous de fixation dans le sol. Convient pour tous les modèles de parasol. Égal au diamètre Siro 35, approprié pour parasols  $\varnothing$  38,  $\varnothing$  48 et  $\varnothing$  58.

Units STD	Packaging Dimensions (cm)	m3/ pack	NW Unit (kg)	Units Container 20'	Units Container 40'	Units Container HC	Units Trayler (70m3)	Units Truck 100m3
1	58x51x9	0,026	35	520				



Negro  
Black  
Noir

**W** 49,5 x **W** 49,5 x **H** 1,8 cm

**W** 19.49 x **W** 19.49 x **H** 0.71 in

# Marquesina



Marquesina plegable de 4 x 3 m en aluminio pintado por pulverización en color gris oscuro con regulador de altura. Tela de poliéster de 300 g/m2 en color marrón. No incluye pie.

Foldable marquee with height regulator. 4 x 3 m (157.48 x 118.11 in) size and spray painted aluminium structure in dark grey. 300 g/m2 brown polyester fabric. Base not included.

Pergola pliante de 4 x 3 m en aluminium peint en gris foncé avec régulateur de hauteur. Toile marron en polyester de 300 g/m2. N'inclut pas le pied.

Units STD	Packaging Dimensions (cm)	m3/ pack	NW Unit (kg)	Units Container 20'	Units Container 40'	Units Container HC	Units Trayler (70m3)	Units Truck 100m3
1	(417x25x16) + (104x31x15)	0,17+0,05	71	91	182	-	-	-



Marrón

Brown

Marron

**W** 400 x **L** 300 x **H** 248 cm

**W** 157.48 x **L** 118.11 x **H** 97.63 in





# Promocional

## Promotional

## Promotionnel

Resol es consciente de la importancia que tiene para sus clientes la personalización de sillas, mesas, taburetes y parasoles. Por este motivo, pone a la disposición de sus clientes las técnicas de inmoulding, serigrafía y adhesivo de alta adherencia. Cada técnica es específica para un tipo de acabado y objetivo. El inmoulding precisa de un estudio previo del producto para su realización. La serigrafía permite colocar el logo de su compañía en cualquier superficie plana y puede ser eliminado mediante productos químicos. El adhesivo de alta adherencia es una posibilidad que sin cantidades mínimas elevadas nos permite ofrecer una personalización rápida y ágil de cualquier tipo de superficie de plástico. Consulte con el Departamento Comercial para tener más información de cualquier de estas técnicas de personalización.

Resol understands the importance to its customers concerning the customization of chairs, tables, stools and umbrellas. For this reason, Resol offers the techniques of inmoulding, screen printing and high tack adhesive. Each technique is specific to a type of finish and objective. The inmoulding requires previous study of the product for the production. The screen printing allows you to place your company logo on any flat surface and it can be removed using chemicals. The high tack adhesive allows Resol to offer fast and flexible customization of any plastic surface with low MOQ. Consult Sales Department for more information on any of these personalization techniques.

Resol comprend l'importance que la personnalisation des chaises, des tables, des tabourets et des parasols a pour ses clients. Pour cette raison, Resol Groupe met à la disposition de ses clients les techniques d'inmoulding, de la sérigraphie et de l'adhésif haute adhérence. Chaque technique est spécifique à un type de finition et objective. Le inmoulding nécessite l'étude précédente du produit pour la production. La sérigraphie permet de placer le logo de votre entreprise sur une surface plane et peut être retiré à l'aide de produits chimiques. L'adhésif haute adhérence permet, sans quantités minimales élevées, d'offrir la personnalisation rapide et flexible de toute surface en plastique. Consultez le Département Comerciale pour plus d'informations sur ces techniques de personnalisation.





tecnologías de personalización personalization technologies technologies de personnalisation	Inmoulding	Serigrafía Screenprint Sérigraphie	Adhesivo Adhesive Adhésif
Se realiza en el momento de la producción de la silla Is performed at the time of production of the chair Est effectuée au moment de la production de la chaise	✓	●	●
Personalización permanente Permanent customization Personnalisation permanente	✓	●	●
Color Colour Couleur	✓	✓	✓



# resol

Esta línea de productos está especialmente indicada para eventos como banquetes y convenciones. Las soluciones presentadas destacan por su tecnología, ligereza, movilidad, resistencia y versatilidad.

This product line is especially suitable for events such as banquets and conventions. The solutions we present stand out for their technology, lightweight, portability, resistance and versatility.

Cette ligne de produits est spécialement appropriée pour des événements tels que banquets et conventions. Les solutions présentées se distinguent par leur technologie, légèreté, mobilité, résistance et leur versatilité.



**Catering y Convenciones**  
**Banquets and Conventions**  
**Banquets et Conventions**

Rossini .....	238	Wagner .....	245	Carro 2 .....	255
Verdi .....	238	Bach .....	245	Carro 3 .....	256
Kraus .....	240	Hamlet 74 .....	246	Carro 5 .....	257
Beethoven .....	240	Hamlet 110 .....	246	Carro 6 .....	258
Mozart .....	241	Sistema de unión de mesas .....	247		
Yago .....	241	Amadeus .....	248		
Strauss .....	242	Ópera .....	248		
Mahler .....	242	Garrotxa .....	250		
Chopin .....	243	Kurt .....	250		
Smart 180 .....	243	Sam .....	252		
Smart banco .....	244	Klaus .....	252		
Vivaldi .....	244	Carro 1 .....	254		

**Complementos textiles para catering**  
**Textile complements for catering**  
**Compléments textiles pour restauration**

Fundas .....	259
Covers / Housses	





Los más de 50 años de experiencia de **Resol** en la fabricación de mobiliario de grandes dimensiones en cualquier material plástico (polipropileno, poliamida, policarbonato, polietileno...) así como en el diseño y construcción de moldes, han permitido a la compañía desarrollar el mejor programa de sillas y mesas "blow moulded" de Polietileno de Alta Densidad para uso profesional.

**Resol Contract es líder mundial en el mercado de mobiliario para hostelería** en productos de tecnología "blow moulded" que destacan por:

**Dureza y capacidad para soportar peso** con estructuras metálicas, uniones y soldaduras súper reforzadas (test de nivel de resistencia de acuerdo con estándar Bifma\*).

**Estabilidad y ergonomía** para el confort de los comensales.

**Resistencia a fuertes impactos.**

**Resistencia a la humedad.**

**Ligereza** para un fácil traslado o transporte.

**Mesas con patas plegables** con un mecanismo fácil y seguro.

**Bajo mantenimiento, fácil limpieza y alta durabilidad.**

La gama más amplia del mercado en **mesas, carros, sillas y fundas** para catering y convenciones.

**More than 50-year experience of Resol** with regard to the manufacturing of king size furniture in any plastic material (polypropylene, polyamide, polycarbonate, polyethylene...) as well as the corresponding mould design and construction, has permitted developing the best High Density Polyethylene "blow moulded" program for chairs and tables for professional use.

**Resol Contract is world leader in the furniture market for "blow moulded" technology products in the hotel industry.** These stand out of:

**Their hardness and capacity for supporting weight** highly reinforced metallic structures, joints and welding (according to Bifma resistance standards\*).

**Their stability and ergonomy.**

**Their resistance to hard impacts.**

**Their resistance to humidty.**

**Their lightness** for easy moving or transport.

**Their leg folding an unfolding mechanism,** easy and safe.

**Their low maintenance, easy cleaning and log durability.**

The most extensive existing range of **tables, trolleys, chairs and covers** for catering and conventions.

**Avec plus de 50 ans d'expérience du Resol** dans la fabrication de mobilier de grandes dimensions toutes matières plastiques (polypropylène, polyamide, polycarbonate, Polyéthylène...) ainsi que dans la conception et la construction des moules, ont permis de mettre en place le meilleur programme de chaises et de tables "blow moulded" en Polyéthylène de Haute Densité à usage professionnel.

**Resol Contract est le leader mondial sur le marché du mobilier pour l'hôtellerie** concernant les produits de technologie "blow moulded". Ces produits se caractérisent par:

**Leur robustesse et capacité à supporter le poids** grâce à leurs structures métalliques, raccords et soudures super-renforcées (en accord avec les demandes BIFMA de résistance\*).

**Leur stabilité et ergonomie.**

**Leur résistance aux impacts violents.**

**Leur résistance à l'humidité.**

**Leur légèreté** pour un transfert ou un transport facile.

**Leur mécanisme de pliage et de dépliage des pieds,** facile et sans risque.

**Leur faible entretien, leur facilité à nettoyer et leur durée de vie élevée.**

La plus grande gamme existente de **tables, chariots, chaises et housses** pour la restauration et les conventions.



Resol es el único fabricante del mundo que ofrece

- Un sistema de mesas conectables que permite cualquier composición, PATENTE U 200800685 (9)
- Dos versiones: ancho 75 / ancho 91
- Resistencia probada para uso contract
- La gama existente más amplia de mesas, carros, sillas y fundas para catering y convenciones

Resol is the only manufacturer in the world who offers

- A system of connectable tables that allow any composition, PATENT U 200800685 (9)
- Two versions: width 75 / width 91
- Proven resistance for catering and hotel use
- The most extensive existing range of tables, trolleys, chairs and covers for catering and conventions

Resol est le seul fabriquant du monde qui propose :

- Un système de tables modulables qui permet quelconque composition, BREVET U 200800685 (9)
- Deux versions: largeur 75 / largeur 91
- Résistance testée pour un usage dans l'hôtellerie
- La plus grande gamme existante de tables, chariots, chaises et housses pour la restauration et les conventions.

\* Según condiciones legales y comerciales establecidas en <http://www.resol.es/es/garantias.aspx>. Solamente para los modelos determinados en estas condiciones de garantía.

\* According to legal and commercial conditions set forth in <http://www.resol.es/es/garantias.aspx>. Only for the models specified in these warranty conditions.

\* Selon les conditions juridiques et commerciales énoncées sur <http://www.resol.es/es/garantias.aspx>. Seulement pour les modèles indiqués avec ces conditions de garantie.





mesa / table / table  
**Rossini**



Mesa plegable con estructura de acero pintado. Sobre de polietileno de alta densidad, en color gris claro. Grosor del sobre: 45 mm. Sobre estanco de una sola pieza sin uniones. Peso neto: 12 kg. Travesaños ergonómicos.

Folding painted steel frame table. Table top of high density polyethylene in light grey. Table top thickness: 45 mm. Leakproof table top in one sole piece without joints. Net weight: 12 kg (26.45 lb). Ergonomic crossbeams.

Table pliable avec structure en acier peint et revêtement en polyéthylène de haute densité de couleur gris clair. Grosseur du plateau de 45 mm. Plateau étanche d'une seule pièce sans raccords. Poids net: 12 kg. Traverses ergonomiques.

Units STD	Packaging Dimensions (cm)	m3/ pack	NW Unit (kg)	Units Container 20'	Units Container 40'	Units Container HC	Units Traylor (70m3)	Units Truck 100m3
1	123x123x5,4	0,09	12	253	505	566	609	871
34	125x125x215	3,36	12	136	306	306	340	408

∅ 122 x H 74 cm  
 ∅ 48.03 x H 29.13 in



Gris claro  
 Light Grey  
 Gris clair



315 kg / 693 lb

✶ x 6



mesa / table / table  
**Verdi**



Mesa plegable con estructura de acero pintado y sobre de polietileno de alta densidad, en color gris claro. Grosor sobre 45 mm. Sobre estanco de una sola pieza sin uniones. Peso neto 19 kg. Travesaños ergonómicos.

Folding table with powder-coated steel frame and high density polyethylene table top. Table top thickness: 45 mm. Single piece table top with no joints. Net weight 19 kg (41.80 lb). Ergonomic crossbeams. Available in light grey.

Table pliante avec structure d'acier peint et plateau en polyéthylène de haute densité couleur gris clair. Grosseur plateau 45 mm. Plateau d'une seule pièce. Poids net 19 kg. Traverses ergonomiques.

Units STD	Packaging Dimensions (cm)	m3/ pack	NW Unit (kg)	Units Container 20'	Units Container 40'	Units Container HC	Units Traylor (70m3)	Units Truck 100m3
1	154x154x5,5	0,14	19	154	320	360	370	529
31	156x156x216	5,25	19	93	217	217	248	279

∅ 152 x H 74 cm  
 ∅ 59.84 x H 29.13 in



Gris claro  
 Light Grey  
 Gris clair



315 kg / 693 lb

✶ x 7



∅: diámetro / diameter / diamètre H: altura / height / hauteur







mesa / table / table  
**Kraus**



Mesa plegable con estructura de acero pintado y sobre de polietileno de alta densidad, en color gris claro. Grosor sobre 50 mm. Sobre estanco de una sola pieza sin uniones. Peso neto 25 kg. Travesaños ergonómicos.

Folding table with powder-coated steel frame and high density polyethylene table top. Table top 50 mm thick. Single piece table top with no joints. Net weight 25 kg (55 lb). Ergonomic crossbeams. Available in light grey.

Table pliante avec structure d'acier peint et plateau en polyéthylène de haute densité couleur gris clair. Grosseur plateau 50 mm. Plateau d'une seule pièce. Poids net 25 kg. Traverses ergonomiques.

Units STD	Packaging Dimensions (cm)	m3/ pack	NW Unit (kg)	Units Container 20'	Units Container 40'	Units Container HC	Units Traylor (70m3)	Units Truck 100m3
1	161x161x6	0,16	25	135	270	333	344	500
31	168x168x215	6,07	25	96	224	224	256	256

∅ 160 x H 74 cm  
∅ 62.99 x H 29.13 in



Gris claro  
Light Grey  
Gris clair



315 kg / 693 lb

8



mesa / table / table  
**Beethoven**



Mesa plegable con estructura de acero pintado y sobre de polietileno de alta densidad, en color gris claro. Grosor sobre 50 mm. Sobre estanco de una sola pieza sin uniones. Peso neto 29 kg. Travesaños ergonómicos.

Folding table with powder-coated steel frame and high density polyethylene table top. Table top 50 mm thick. Single piece table top with no joints. Net weight 29 kg (63.93 lb). Ergonomic crossbeams. Available in light grey.

Table pliante avec structure d'acier peint et plateau en polyéthylène de haute densité couleur gris clair. Grosseur plateau 50 mm. Plateau d'une seule pièce. Poids net 29 kg. Traverses ergonomiques.

Units STD	Packaging Dimensions (cm)	m3/ pack	NW Unit (kg)	Units Container 20'	Units Container 40'	Units Container HC	Units Traylor (70m3)	Units Truck 100m3
1	182x182x6,5	0,22	29	105	210	235	253	362
25	182x182x215	6,89	29	87	174	174	240	270

∅ 180 x H 74 cm  
∅ 70.86 x H 29.13 in



Gris claro  
Light Grey  
Gris clair



350 kg / 770 lb

9



∅: diámetro / diameter / diamètre H: altura / height / hauteur

\* Según condiciones legales y comerciales establecidas en <http://www.resol.es/es/garantias.aspx>. Solamente para los modelos determinados en estas condiciones de garantía.  
According to legal and commercial conditions set forth in <http://www.resol.es/es/garantias.aspx>. Only for certain models in these warranty conditions.  
Selon les conditions juridiques et commerciales énoncées dans <http://www.resol.es/es/garantias.aspx>. Seulement pour certains modèles dans ces conditions de garantie.

mesa / table / table

# Mozart



Mesa plegable con estructura de acero pintado y sobre de polietileno de alta densidad, en color gris claro. Grosor sobre 50 mm. Sobre estanco de una sola pieza sin uniones. Peso neto 33 kg. Travesaños ergonómicos.

Folding table with powder-coated steel frame and high density polyethylene table top. Table top 50 mm thick. Single piece table top with no joints. Net weight 33 kg (72.60 lb). Ergonomic crossbeams. Available in light grey.

Table pliante avec structure d'acier peint et plateau en polyéthylène de haute densité couleur gris clair. Grosseur plateau 50 mm. Plateau d'une seule pièce. Poids net 33 kg. Traverses ergonomiques.

Units STD	Packaging Dimensions (cm)	m3/ pack	NW Unit (kg)	Units Container 20'	Units Container 40'	Units Container HC	Units Traylor (70m3)	Units Truck 100m3
1	202x202x6,5	0,26	33	98	175	200	234	258
27	204x204x220	9,15	33	60	150	150	180	180

∅ 200 x H 74 cm  
∅ 78.74 x H 29.13 in



Gris claro  
Light Grey  
Gris clair



350 kg / 770 lb

1 x 10



mesa / table / table

# Yago



Mesa plegable con estructura de acero pintado y sobre de polietileno de alta densidad, en color gris claro. Grosor del sobre: 45 mm. Sobre estanco de una sola pieza sin uniones. Peso neto: 9 kg. Travesaños ergonómicos.

Folding table with painted steel frame and high density polyethylene table top in light grey. Table top thickness: 45 mm. Leakproof table top in one sole piece without joints. Net weight: 9 kg (19.84 lb). Ergonomic crossbeams.

Table pliable avec structure en acier peint et revêtement en polyéthylène de haute densité de couleur gris clair. Grosseur du plateau de 45 mm. Plateau étanche d'une seule pièce sans raccords. Poids net: 9 kg. Traverses ergonomiques.

Units STD	Packaging Dimensions (cm)	m3/ pack	NW Unit (kg)	Units Container 20'	Units Container 40'	Units Container HC	Units Traylor (70m3)	Units Truck 100m3
1	89x89x5,4	0,05	9	502	1.004	1.125	1.211	1.731
36	91x91x226	1,87	9	432	864	864	1.008	1.152

L 87 x W 87 x H 74 cm  
L 34.25 x W 34.06 x H 29.13 in



Gris claro  
Light Grey  
Gris clair



300 kg / 660 lb

1 x 4



∅: diámetro / diameter / diamètre W: ancho / width / largeur L: largo / length / longueur H: altura / height / hauteur

\* Según condiciones legales y comerciales establecidas en <http://www.resol.es/garantias.aspx>. Solamente para los modelos determinados en estas condiciones de garantía. According to legal and commercial conditions set forth in <http://www.resol.es/garantias.aspx>. Only for certain models in these warranty conditions. Selon les conditions juridiques et commerciales énoncées dans <http://www.resol.es/garantias.aspx>. Seulement pour certains modèles dans ces conditions de garantie.



mesa / table / table

## Strauss



Mesa plegable con estructura de acero pintado y sobre de polietileno de alta densidad, en color gris claro. Grosor sobre 45 mm. Sobre estanco de una sola pieza sin uniones. Peso neto 9 kg. Travesaños ergonómicos.

Folding table with powder-coated steel frame and high density polyethylene table top. Table top thickness: 45 mm. Single piece table top with no joints. Net weight 9 kg (19,84 lb). Ergonomic crossbeams. Available in light grey.

Table pliante avec structure d'acier peint et plateau en polyéthylène de haute densité couleur gris clair. Grosseur plateau 45 mm. Plateau d'une seule pièce. Poids net 9 kg. Traverses ergonomiques.

Units STD	Packaging Dimensions (cm)	m3/ pack	NW Unit (kg)	Units Container 20'	Units Container 40'	Units Container HC	Units Traylor (70m3)	Units Truck 100m3
1	123x62x5,4	0,05	9	571	1.142	1.279	1.378	1.968
36	125x64x226	1,81	9	432	972	972	1.080	828

L 122 x W 61 x H 74 cm

L 48.03 x W 24.02 x H 29.13 in



270 kg / 594 lb



Gris claro

Light Grey

Gris clair



mesa / table / table

## Mahler



Mesa plegable con estructura de acero pintado y sobre de polietileno de alta densidad, en color gris claro. Grosor del sobre: 45 mm. Sobre estanco de una sola pieza sin uniones. Peso neto: 12 kg. Travesaños ergonómicos. La unión de 2 mesas Mahler permite una composición de 150 x 150 cm. Sistema de unión longitudinal de mesas.

Folding table with painted steel frame and high density polyethylene table top in light grey. Table top thickness: 45 mm. Leakproof table top in one sole piece without joints. Net weight: 12 kg (26.45 lb). Ergonomic crossbeams. The joining of 2 Mahler tables permits a composition of 150 x 150 cm. Longitudinal joining system of the tables.

Table pliable avec structure en acier peint et revêtement en polyéthylène de haute densité de couleur gris clair. Grosseur du plateau de 45 mm. Plateau étanche d'une seule pièce sans raccords. Poids net: 12 kg. Traverses ergonomiques. Le raccord de 2 Mahlers permet une composition de 150 x 150 cm. Système de raccord longitudinal des tables.

Units STD	Packaging Dimensions (cm)	m3/ pack	NW Unit (kg)	Units Container 20'	Units Container 40'	Units Container HC	Units Traylor (70m3)	Units Truck 100m3
1	153x77x5,4	0,07	12	375	750	840	905	1.293
36	156x78x226	2,75	12	252	540	540	864	972

L 152 x W 75,5 x H 74 cm

L 59.84 x W 29.72 x H 29.13 in



270 kg / 594 lb



Gris claro

Light Grey

Gris clair

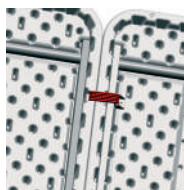

W: ancho / width / largeur L: largo / length / longueur H: altura / height / hauteur

mesa / table / table

## Chopin

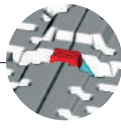
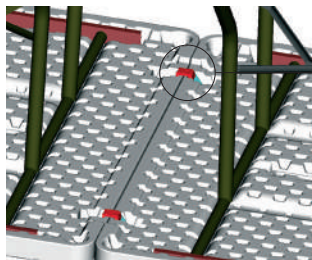

Sistema de unión de mesas  
Table joining system  
Système d'union des tables

Mesa plegable con estructura de acero pintado y sobre de polietileno de alta densidad, en color gris claro. Grosor sobre 45 mm. Sobre estanco de una sola pieza sin uniones. Peso neto 14 kg. Travesaños ergonómicos. Sistema de unión de mesas.

Folding table with powder-coated steel frame and high density polyethylene table top. Table top 45 mm thick. Single piece table top with no joints. Net weight 14 kg (30.86 lb). Ergonomic crossbeams. Available in light grey. Table joining system.

Table pliante avec structure d'acier peint et plateau en polyéthylène de haute densité couleur gris clair. Grosseur plateau 45 mm. Plateau d'une seule pièce. Poids net 14 kg. Traverses ergonomiques. Système d'union des tables.

Units STD	Packaging Dimensions (cm)	m3/ pack	NW Unit (kg)	Units Container 20'	Units Container 40'	Units Container HC	Units Trayler (70m3)	Units Truck 100m3
1	184x77x5,4	0,08	14	333	690	773	832	1.189
36	187x80x226	3,38	14	252	540	540	756	684

L 183 x W 75,5 x H 74 cm

L 72.05 x W 29.72 x H 29.13 in



315 kg / 693 lb



Gris claro  
Light Grey  
Gris clair



Marrón  
Brown  
Brun

6 x



mesa / table / table

## Smart 180



Mesa plegable con estructura de acero pintado y sobre de polietileno de alta densidad, en color blanco. Sobre de 45 mm de grosor con asa para fácil transporte. Tablero articulado para un óptimo almacenaje. Peso neto: 14 kg. Travesaños ergonómicos.

Folding table with painted steel structure and high density polyethylene table top in white. Table top with a 45 mm thickness and easy to carry handle. Articulated table top board for optimum storage. Net weight: 14 kg (30.86 lb). Ergonomic crossbeams.

Table pliable avec structure en acier peint et plateau en polyéthylène de haute densité de couleur blanche. Plateau de 45 mm. de grosseur avec anse pour faciliter le transport. Plateau articulé pour permettre un rangement optimum. Poids net: 14 kg.

Units STD	Packaging Dimensions (cm)	m3/ pack	NW Unit (kg)	Units Container 20'	Units Container 40'	Units Container HC	Units Trayler (70m3)	Units Truck 100m3
1	94x76x9,5	0,07	14	342	684	766	825	1.179
19	215x96x76	1,53	14	342	684	684	798	855

L 182 x W 75,5 x H 74 cm

L 71.85 x W 29.73 x H 29.13 in



315 kg / 693 lb



Gris claro  
Light Grey  
Gris clair

6 x

W: ancho / width / largeur L: largo / length / longueur H: altura / height / hauteur

\* Según condiciones legales y comerciales establecidas en <http://www.resol.es/garantias.aspx>. Solamente para los modelos determinados en estas condiciones de garantía.

According to legal and commercial conditions set forth in <http://www.resol.es/garantias.aspx>. Only for certain models in these warranty conditions.

Selon les conditions juridiques et commerciales énoncées dans <http://www.resol.es/garantias.aspx>. Seulement pour certains modèles dans ces conditions de garantie.



mesa / table / table

## Banco Smart



Banco plegable con estructura de acero pintado y asiento de polietileno de alta densidad, en color blanco. Asiento de 50 mm de grosor con asa para fácil transporte. Asiento articulado para un óptimo almacenaje. Peso neto: 7,7 kg.

Folding bench with painted steel structure and high density polyethylene seat in white. Seat with a 50 mm thickness and easy to carry handle. Articulated seat for optimum storage. Net weight: 7,7 kg (16.97 lb).

Banc pliable avec structure en acier peint et siège en polyéthylène de haute densité de couleur blanche. Siège de 50 mm. de grosseur avec anse pour faciliter le transport. Siège articulé pour un rangement optimum. Poids net: 7,7 kg.

Units STD	Packaging Dimensions (cm)	m3/ pack	NW Unit (kg)	Units Container 20'	Units Container 40'	Units Container HC	Units Trayler (70m3)	Units Truck 100m3
1	92,5x28,5x9	0,03	7,7	840	1.680	1.932	2.464	3.200
70	92x113x217	2,25	7,7	840	1.820	1.820	1.960	2.240

L 183 x W 28 x H 42,5 cm

L 72.05 x W 11.02 x H 16.73 in



Gris claro

Light Grey

Gris clair



400 kg / 880 lb



mesa / table / table

## Vivaldi



Mesa plegable con estructura de acero pintado y sobre de polietileno de alta densidad, en color gris claro. Grosor sobre 45 mm. Sobre estanco de una sola pieza sin uniones. Peso neto 18,5 kg. Travesaños ergonómicos. Sistema de unión de mesas.

Folding table with powder-coated steel frame and high density polyethylene table top. Table top 45 mm thick. Net weight 18,5 kg (40.78 lb). Single piece table top with no joints. Ergonomic crossbeams. Table joining system. Available in light grey.

Table pliante avec structure d'acier peint et plateau en polyéthylène de haute densité couleur gris clair. Grosseur plateau 45 mm. Plateau d'une seule pièce. Poids net 18,5 kg. Traverses ergonomiques. Système d'union des tables.

Units STD	Packaging Dimensions (cm)	m3/ pack	NW Unit (kg)	Units Container 20'	Units Container 40'	Units Container HC	Units Trayler (70m3)	Units Truck 100m3
1	202x92,5x5,4	0,11	18,5	256	512	573	617	882
36	202x94x226	4,29	18,5	216	432	432	504	540

L 200 x W 90 x H 74 cm

L 78.74 x W 35.43 x H 29.13 in



Gris claro

Light Grey

Gris clair



350 kg / 770 lb

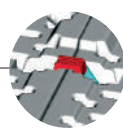
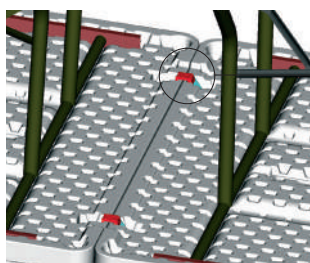
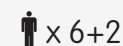

Sistema de unión de mesas  
Table joining system  
Système d'union des tables

W: ancho / width / largeur L: largo / length / longueur H: altura / height / hauteur

mesa / table / table

## Wagner



Mesa plegable con estructura de acero pintado y sobre de polietileno de alta densidad, en color gris claro. Grosor del sobre: 50 mm. Sobre estanco de una sola pieza sin uniones. Peso neto: 20 kg. Travesaños ergonómicos.

Folding table with painted steel frame and high density polyethylene table top in light grey. Table top thickness: 50 mm. Leakproof table top in one sole piece without joints. Net weight: 20 kg (44.09 lb). Ergonomic crossbeams.

Table pliante avec structure en acier peint et plateau en polyéthylène de haute densité de couleur gris clair. Grosseur plateau 50 mm. Plateau étanche d'une seule pièce sans raccords. Poids net: 20 kg. Traverses ergonomiques.



Units STD	Packaging Dimensions (cm)	m3/pack	NW Unit (kg)	Units Container 20'	Units Container 40'	Units Container HC	Units Traylor (70m3)	Units Truck 100m3
1	244x77,5x5,4	0,11	20	184	368	412	444	634
31	197x80x242	3,81	20	124	248	248	465	558

L 243 x W 75,5 x H 74 cm

L 93.70 x W 29.72 x H 29.13 in



350 kg / 770 lb



Gris claro

Light Grey

Gris clair



mesa / table / table

## Bach



Mesa plegable con estructura de acero pintado y sobre de polietileno de alta densidad, en color gris claro. Grosor sobre 45 mm. Sobre estanco de una sola pieza sin uniones. Peso neto 10 kg. Travesaños ergonómicos.

Folding table with powder-coated steel frame and high density polyethylene table top. Table top 45 mm thick. Single piece table top with no joints. Net weight 10 kg (22.05 lb). Ergonomic crossbeams.

Table pliante avec structure d'acier peint et plateau en polyéthylène de haute densité couleur gris clair. Grosseur plateau 45 mm. Plateau d'une seule pièce. Poids net 10 kg. Traverses ergonomiques.

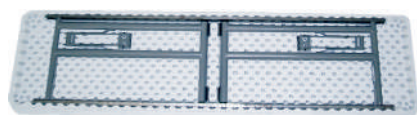
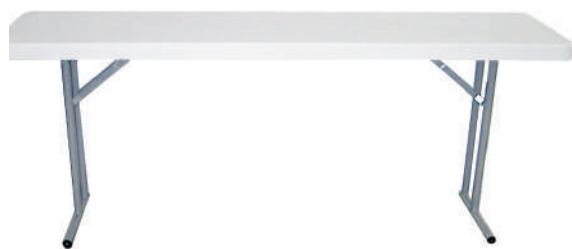

Units STD	Packaging Dimensions (cm)	m3/pack	NW Unit (kg)	Units Container 20'	Units Container 40'	Units Container HC	Units Traylor (70m3)	Units Truck 100m3
1	184,5x47x5,4	0,06	10	457	914	1.024	1.103	1.575
62	187x97x197	3,57	10	372	744	744	868	1.240

L 183 x W 45 x H 74 cm

L 72.04 x W 17.72 x H 29.13 in



315 kg / 693 lb



Gris claro

Light Grey

Gris clair



W: ancho / width / largeur L: largo / length / longueur H: altura / height / hauteur

\* Según condiciones legales y comerciales establecidas en <http://www.resol.es/garantias.aspx>. Solamente para los modelos determinados en estas condiciones de garantía.

According to legal and commercial conditions set forth in <http://www.resol.es/garantias.aspx>. Only for certain models in these warranty conditions.

Selon les conditions juridiques et commerciales énoncées dans <http://www.resol.es/garantias.aspx>. Seulement pour certains modèles dans ces conditions de garantie.



mesa / table / table

## Hamlet 74



Mesa plegable con estructura de acero pintado. Sobre de polietileno de alta densidad. Color gris claro. Grosor del sobre: 45 mm. Sobre de estanco de una sola pieza sin uniones. Peso neto: 7,5 kg.

Folding painted steel frame table. Table top of high density polyethylene. Light grey colour. Table top thickness: 45 mm (1.8 in). Leak proof table top in one sole piece without joints. Net weight: 7,5 kg (34.25 lb).

Table pliante avec structure en acier peint et revêtement en polyéthylène de haute densité. Couleur gris clair. Grosseur du plateau: 45 mm. Plateau étanche d'une seule pièce sans raccords. Poids net: 7,5 kg.

Units STD	Packaging Dimensions (cm)	m3/ pack	NW Unit (kg)	Units Container 20'	Units Container 40'	Units Container HC	Units Traylor (70m3)	Units Truck 100m3
1	105x82x5,4	0,05	7,5	423	846	948	1.021	1.458
36	164x112x117	2,15	7,5	-	912	992	-	-

∅ 80 x H 74 cm

∅ 31.49 x H 29,13 in



170 kg / 374 lb



Gris claro  
Light Grey  
Gris clair

mesa / table / table

## Hamlet 110



Mesa plegable con estructura de acero pintado y sobre de polietileno de alta densidad. Color gris claro. Grosor del sobre: 45 mm. Sobre de estanco de una sola pieza sin uniones. Peso neto: 8 kg.

Folding table with painted steel frame and high density polyethylene table top. Light grey colour. Table top thickness: 45 mm (1.8 in). Leak proof table top in one sole piece without joints. Net weight: 8 kg (17.95 lb).

Table pliante avec structure en acier peint et revêtement en polyéthylène de haute densité. Couleur gris clair. Grosseur du plateau de 45 mm. Plateau étanche d'une seule pièce sans raccords. Poids net : 8 kg.

Units STD	Packaging Dimensions (cm)	m3/ pack	NW Unit (kg)	Units Container 20'	Units Container 40'	Units Container HC	Units Traylor (70m3)	Units Truck 100m3
1	137x82x5,4	0,05	8	423	846	948	1.021	1.458
31	142x85x197	2,38	8	430	860	860	558	620

∅ 80 x H 110 cm

∅ 31.49 x H 43.31 in



170 kg / 374 lb



Gris claro  
Light Grey  
Gris clair

∅: diámetro / diameter / diamètre W: ancho / width / largeur L: largo / length / longueur H: altura / height / hauteur

## Sistema de unión de mesas

### Table joining system

### Système d'union de tables

Sistema de mesas conectables que permite cualquier composición - PATENTE U 200800685 (9).

A system of conectable tables that allow any composition, PATENT U 200800685 (9).

Un système de tables modulables qui permet quelconque composition, BREVET U 200800685 (9).

Chopin + Chopin ((183+183)x75)

Vivaldi + Vivaldi (198+198)x91)

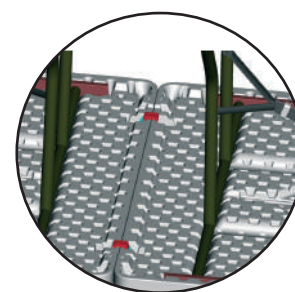

Mahler + Mahler ((75+75)x150)

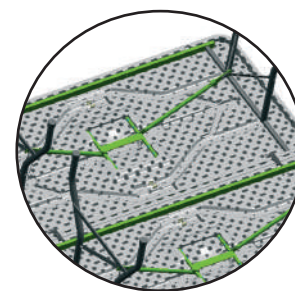



silla / chaise / chair

## Amadeus



Silla apilable de aluminio lacado y espuma inyectada tapizada. Disponible en tela estándar y –bajo pedido– en CRIB-5.

Stackable lacquered aluminium chair with injected upholstered foam. Available in standard fabric and CRIB-5 fabric (upon request).

Chaise empilable en aluminium laqué et mousse injectée tapissée. Disponible en toile standard et –sur commande– en toile non-feu CRIB-5.

Tamaño tubo / Tube size / Taille du tube	25 mm
Grosor tubo / Tube thickness / Grosseur du tube	2 mm
Capas de pintura / Coats of paint / Couches de peinture	3
Grosor asiento espuma inyectada / Injected foam seat thickness / Grosseur de l'assise en mousse injectée	50 mm
Gramaje tela / Fabric weight / Grammage de la toile	300 grs/m2
Válvula de respiración / Breathing valve / Valve de respiration	



**W** 45 x **L** 52 x **H** 93 cm  
**W** 17.72 x **L** 20.47 x **H** 36.61 in

Units STD	Packaging Dimensions (cm)	m3/ pack	NW Unit (kg)	Units Container 20'	Units Container 40'	Units Container HC	Units Trayler (70m3)	Units Truck 100m3
12	47x67x230	0,72	3,2	480	1.056	1.056	1.200	1.380

Estructura oro  
Gold structure  
Structure or



Azul  
Blue  
Bleu



Burdeos  
Burgundy  
Bordeaux

Estructura plata  
Silver structure  
Structure argent



Azul  
Blue  
Bleu



Burdeos  
Burgundy  
Bordeaux

Estructura negra  
Black structure  
Structure noire



Antracita  
Anthracite  
Anthracite

silla / chaise / chair

## Ópera



Silla apilable de aluminio lacado y espuma inyectada tapizada. Disponible en tela estándar y -bajo pedido- en CRIB-5. Estructura oro.

Stackable lacquered aluminium chair with injected upholstered foam. Available in standard fabric and CRIB-5 fabric (upon request). Gold structure.

Chaise empilable en aluminium laqué et mousse injectée tapissée. Disponible en toile standard et –sur commande– en toile non-feu CRIB-5. Structure or.

Tamaño tubo / Tube size / Taille du tube	25 mm
Grosor tubo / Tube thickness / Grosseur du tube	2 mm
Capas de pintura / Coats of paint / Couches de peinture	3
Grosor asiento espuma inyectada / Injected foam seat thickness / Grosseur de l'assise en mousse injectée	50 mm
Gramaje tela / Fabric weight / Grammage de la toile	300 grs/m2
Válvula de respiración / Breathing valve / Valve de respiration	



**W** 45 x **L** 52 x **H** 93 cm  
**W** 17.72 x **L** 20.47 x **H** 36.61 in



Azul  
Blue  
Bleu



Burdeos  
Burgundy  
Bordeaux







silla / chaise / chair

## Garrotxa



Silla apilable para interior y exterior de polipropileno inyectado. Especialmente indicada para ser cubierta con una funda para su utilización en banquetes. Peso neto 2,60 kg. Protección UV.

Polypropylene-injected stackable chair for indoor and outdoor use. Chair cover recommended for use in banquets. Net weight 2.60 kg (5.72 lb). UV protection.

Chaise empilable en polypropylène pour intérieur et extérieur. Possibilité de recouvrir la chaise d'une housse lors des banquetes. Poids net 2,60 kg. UV protection.

Units STD	Packaging Dimensions (cm)	m3/ pack	NW Unit (kg)	Units Container 20'	Units Container 40'	Units Container HC	Units Traylor (70m3)	Units Truck 100m3
22	60x46x240	0,66	2,6	1.100	2.420	-	2.926	-
24	60x46x255	0,7	2,6	-	-	2.640	-	3.360
88	110x90x240	2,38	2,6	-	-	-	2.464	-



**W** 43,6 x **L** 52 x **H** 89 cm

**W** 17.17 x **L** 20.47 x **H** 35.04 in

Blanco  
White  
Blanc

Verde  
Green  
Vert

Negro  
Black  
Noir

silla / chaise / chair

## Kurt



Silla apilable de respaldo alto para interior y exterior de polipropileno inyectado. Especialmente indicada para ser cubierta con una funda para su utilización en banquetes. Peso neto: 3 kg. Protección UV.

Polypropylene-injected stackable high back chair for indoor and outdoor use. Especially indicated for using with a chair cover at banquets. Net weight: 3 kg (6.6 lb). UV protection.

Chaise empilable avec dossier haut en polypropylène pour intérieur et extérieur. Possibilité de recouvrir la chaise d'une housse lors des banquetes. Poids net: 3 kg. UV protection.

Units STD	Packaging Dimensions (cm)	m3/ pack	NW Unit (kg)	Units Container 20'	Units Container 40'	Units Container HC	Units Traylor (70m3)	Units Truck 100m3
48	80x110x220	1,94	3	672	1.440	1.440	1.728	1,872



**W** 43 x **L** 47 x **H** 97 cm

**W** 16.93 x **L** 18.50 x **H** 38.19 in

Blanco  
White  
Blanc





silla / chaise / chair

## Sam



Sistema de enlace  
Clamp connection  
Pince ensablement

Silla plegable con estructura de acero pintado, con respaldo y asiento en polipropileno de alta densidad en 2 versiones: gris o negro. Disponible con sistema de enlace de sillas para convenciones y eventos. Protección UV.

Folding chair with powder-coated steel structure. High density polypropylene back and seat. Available in grey and black. Clamp connection of chairs for conventions and events available. UV protection.

Chaise pliante avec structure en acier peint, avec dossier et siège en polypropylène de haute densité en 2 versions: gris ou noir. Pince de jonction des chaises pour conventions et événements disponible. UV protection.

Units STD	Packaging Dimensions (cm)	m3/ pack	NW Unit (kg)	Units Container 20'	Units Container 40'	Units Container HC	Units Traylor (70m3)	Units Truck 100m3
8	45x30,50x98	0,13	3,5	2.100	4.200	5.000	5.200	7.060



Gris claro  
Light Grey



Negro  
Black

**W** 45,5 x **L** 49,5 x **H** 81,5 cm

**W** 17.91 x **L** 19.48 x **H** 32.08 in

ASOCIADO Nº01684

**AIDIMA**  
INSTITUTO TECNOLÓGICO  
MUEBLE, MADERA, ESQUELALÉ Y MÁS

silla / chaise / chair

## Klaus



Silla plegable con estructura de acero pintado gris, con respaldo y asiento en polietileno de alta densidad color gris claro. Protección UV. Incluye clip de seguridad para cumplimiento normativa contract.

Folding chair with powder-coated steel frame in grey. High density polyethylene back and seat. Available in light grey. UV protection. Safety clip to comply with contract standards.

Chaise pliante avec structure en acier peint en gris, avec dossier et siège en polyéthylène de haute densité couleur gris clair. UV protection. Clip de sécurité pour répondre à la norme contract.

Units STD	Packaging Dimensions (cm)	m3/ pack	NW Unit (kg)	Units Container 20'	Units Container 40'	Units Container HC	Units Traylor (70m3)	Units Truck 100m3
4	114x27x47	0,17	4,75	772	1.544	1.728	1.860	2.660



Gris claro  
Light Grey

**W** 49 x **L** 46 x **H** 85 cm

**W** 12.29 x **L** 18.11 x **H** 33.46

Gris clair

ASOCIADO Nº01684

**AIDIMA**  
INSTITUTO TECNOLÓGICO  
MUEBLE, MADERA, ESQUELALÉ Y MÁS

UNE EN 581-2:2009



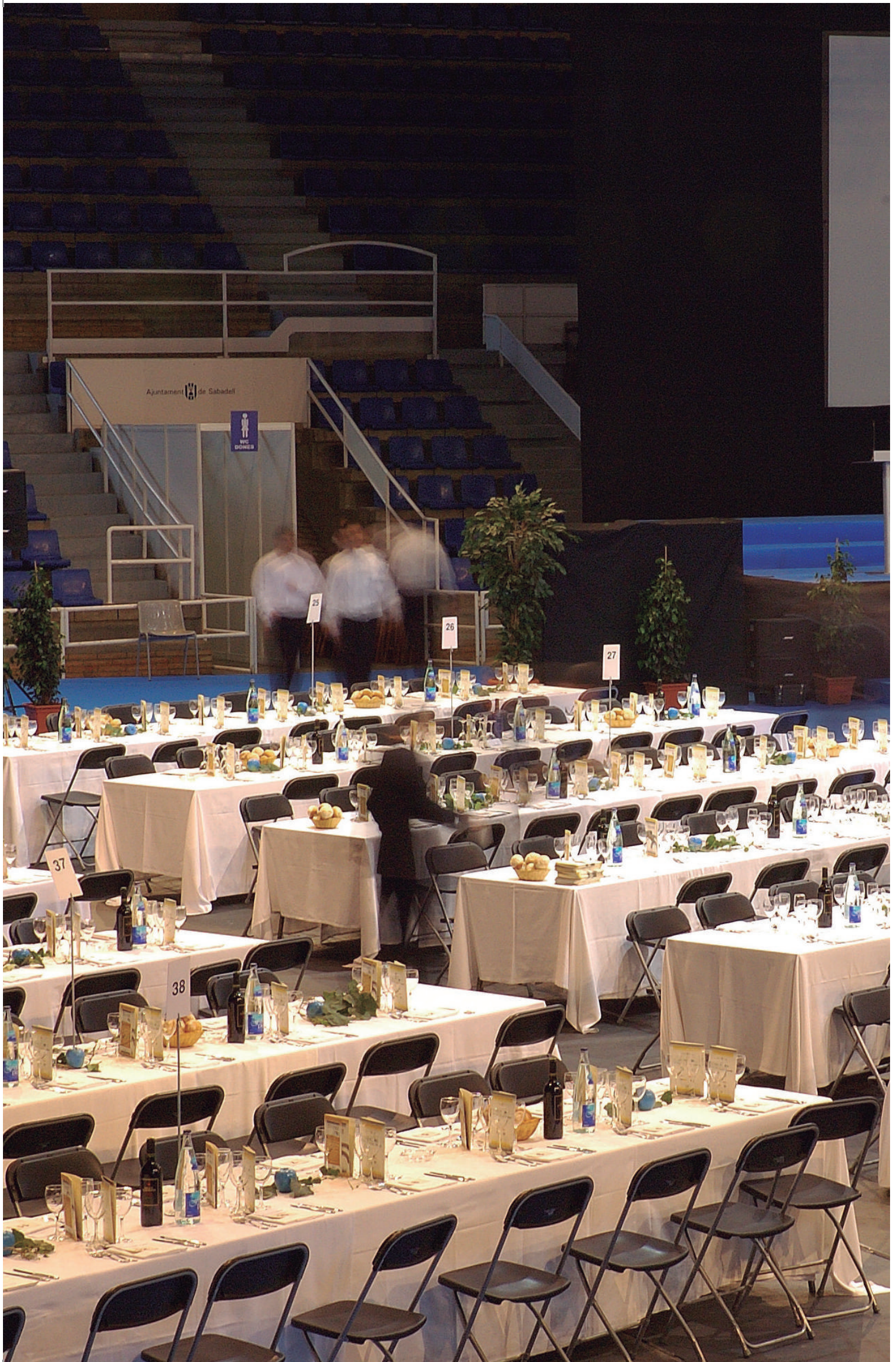



carro / trolley / chariot

# Carro 1

## Beethoven / Verdi / Kraus Rossini / Mozart



Carro con mango extensible para mesas Beethoven, Verdi, Kraus, Rossini y Mozart. Estructura de acero pintado en color gris. Amplia plataforma de apoyo para las mesas en su posición vertical. Ruedas de poliuretano con frenos incorporados. Mango extensible 3 posiciones para adaptarlo a las diferentes mesas.

Capacidad: 12 mesas Beethoven, 12 mesas Verdi, 12 mesas Kraus, 15 mesas Rossini y 12 mesas Mozart.

Trolley with extensible handle for the Beethoven, Verdi, Kraus, Rossini and Mozart tables. Painted grey steel structure. Wide supporting platform for the tables in vertical position. Polyurethane wheels with incorporated brakes. Extensible 3-position handle for adapting it to the different tables.

Capacity: 12 Beethoven tables, 12 Verdi tables, 12 Kraus tables, 15 Rossini tables and 12 Mozart tables.

Chariot avec poignée extensible pour tables Beethoven, Verdi, Kraus, Rossini et Mozart. Structure en acier peint de couleur grise. Grande plateforme de soutien pour les tables positionnées à la verticale. Roues en polyuréthane avec freins incorporés. Manche extensible à 3 positions, adaptable aux différentes tables.

Capacité: 12 Beethoven, 12 Verdi, 12 Kraus, 15 Rossini et 12 Mozart.

Units STD	Packaging Dimensions (cm)	m3/ pack	NW Unit (kg)	Units Container 20'	Units Container 40'	Units Container HC	Units Traylor (70m3)	Units Truck 100m3
1	140x102x15	0,21	42	157	315	353	380	543

**W** 83 x **L** 132 x **H** 112 cm

**W** 32.68 x **L** 51.97 x **H** 44.09 in

Gris claro

Light Grey

Gris clair

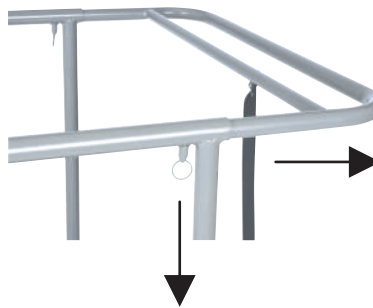

carro / trolley / chariot

# Carro 2 Strauss

Carro con mango abatible para mesa Strauss. Estructura de acero pintado en color gris. Postes verticales extraíbles en el perímetro del carro para inmovilizar las mesas apiladas. Ruedas de poliuretano con frenos incorporados. Capacidad: 20 mesas Strauss.

Trolley with folding handle for Strauss tables. Painted grey steel structure. Extractable vertical posts around the trolley in order to immobilize the stacked tables. Polyurethane wheels with incorporated brakes. Capacity: 20 Strauss tables.

Chariot avec poignée rabattable pour table Strauss. Structure en acier peint de couleur grise. Poteaux verticaux extractibles dans le périmètre du chariot pour immobiliser les tables empilées. Roues en polyuréthane avec freins incorporés. Capacité: 20 tables Strauss



Units STD	Packaging Dimensions (cm)	m3/ pack	NW Unit (kg)	Units Container 20'	Units Container 40'	Units Container HC	Units Traylor (70m3)	Units Truck 100m3
1	138x72x15	0,15	21,3	156	312	349	376	537

**W** 62 x **L** 132 x **H** 115 cm  
**W** 24.41 x **L** 51.97 x **H** 45.28 in

Gris claro  
Light Grey  
Gris clair

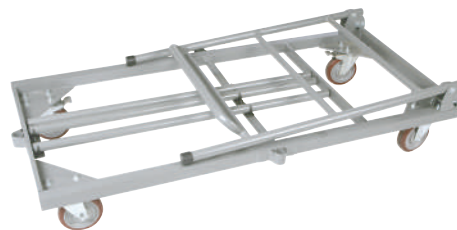
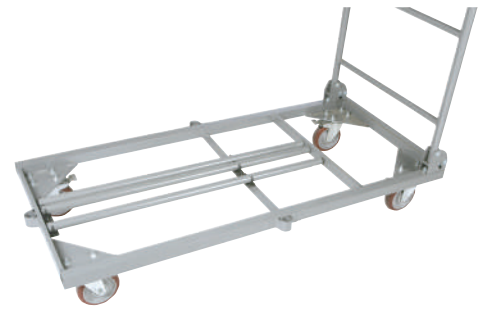



carro / trolley / chariot

# Carro 3 Chopin / Mahler

Carro con mango abatible y base extensible para mesas Chopin, Wagner y Mahler. Estructura de acero pintado en color gris. Postes verticales extraíbles en el perímetro del carro para inmovilizar las mesas apiladas. Ruedas de poliuretano con frenos incorporados. Capacidad: 20 mesas Chopin, 18 mesas Wagner, y 20 Mahler.

Trolley with folding handle and extensible base for Chopin, Wagner and Mahler tables. Painted grey steel structure. Extractable vertical posts around the trolley in order to immobilize the stacked tables. Polyurethane wheels with incorporated brakes. Capacity: 20 Chopin tables, 18 Wagner tables and 20 Mahler tables.

Chariot avec poignée rabattable et base extensible pour tables Chopin, Wagner et Mahler. Structure en acier peint de couleur grise. Poteaux verticaux extractibles dans le périmètre du chariot pour immobiliser les tables empilées. Roues en polyuréthane avec freins incorporés. Capacité: 20 tables Chopin, 18 tables Wagner, et 20 Mahler.

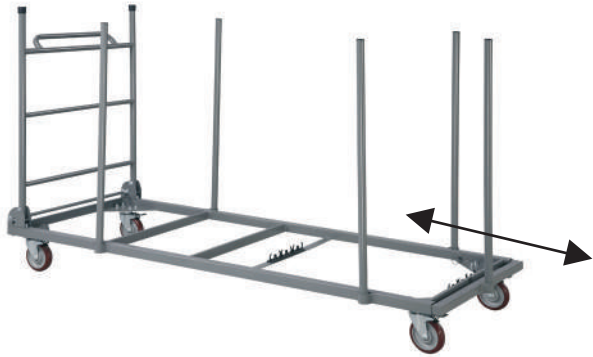

Units STD	Packaging Dimensions (cm)	m3/ pack	NW Unit (kg)	Units Container 20'	Units Container 40'	Units Container HC	Units Trayler (70m3)	Units Truck 100m3
1	196x85x15	0,25	32	92	184	206	222	310

**W** 77 x **L** 191 + 61 x **H** 115 cm

**W** 30.31 x **L** 75.19 + 24.01 x **H** 45.28 in

Ajustable/Extensible/Rallonge

Gris claro

Light Grey

Gris clair



carro / trolley / chariot

# Carro 5 Klaus



Carro para sillas Klaus. Estructura de acero pintado en color gris. Montantes verticales en el perímetro del carro para inmovilizar las sillas apiladas. Ruedas de poliuretano con frenos incorporados. Doble asa de sujeción.  
Capacidad: 30 sillas Klaus

Trolley for Bony chairs. Painted grey steel structure. Extractable vertical posts around the trolley in order to immobilize the stacked chairs. Polyurethane wheels with incorporated brakes. Double gripping handles.  
Capacity: 30 Klaus chairs

Chariot pour chaises Bony. Structure en acier peint de couleur grise. Montants verticaux extractibles dans le périmètre du chariot pour immobiliser les chaises empilées. Roues en polyuréthane avec freins incorporés. Double poignée de fixation.  
Capacité: 30 chaises Klaus

Units STD	Packaging Dimensions (cm)	m3/ pack	NW Unit (kg)	Units Container 20'	Units Container 40'	Units Container HC	Units Trayler (70m3)	Units Truck 100m3
1	114x52x12	0,07	19,73	328	656	735	791	1.131

W 48 x L 110 x H 190 cm

W 18.90 x L 43.31 x H 74.80 in

Gris claro  
Light Grey  
Gris clair

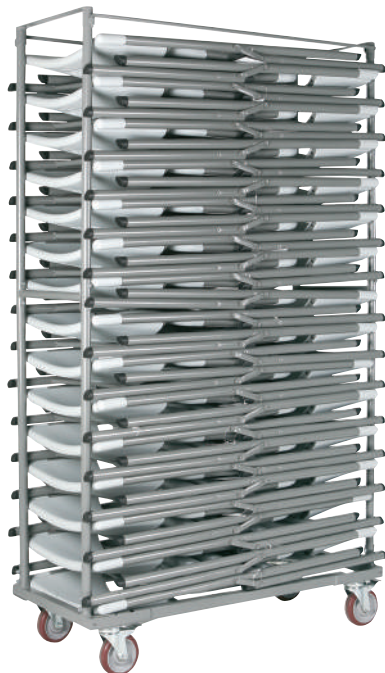



carro / trolley / chariot

# Carro 6 Sam



Carro para sillas Sam. Estructura de acero pintado en color gris. Montantes verticales en el perímetro del carro para inmovilizar las sillas apiladas. Ruedas de poliuretano con frenos incorporados. Doble asa de sujeción que sobresale 2 cm de la estructura. Capacidad: 60 sillas Sam.

Trolley for Sam chairs. Painted grey steel structure. Extractable vertical posts around the trolley in order to immobilize the stacked chairs. Polyurethane wheels with incorporated brakes. Double gripping handles that protrude 2 cm from the structure. Capacity: 60 Sam chairs.

Chariot pour chaises Sam. Structure en acier peint de couleur grise. Goujons verticaux extractibles dans le périmètre du chariot pour immobiliser les chaises empilées. Roues en polyuréthane avec freins incorporés. Double poignée de fixation dépassant de 2 cm de la structure. Capacité: 60 chaises Sam.

Units STD	Packaging Dimensions (cm)	m3/ pack	NW Unit (kg)	Units Container 20'	Units Container 40'	Units Container HC	Units Trayler (70m3)	Units Truck 100m3
1	98x50x15	0,06	18	377	754	845	910	1.300

**W** 48 x **L** 112 x **H** 197 cm

**W** 18.89 x **L** 44.09 x **H** 77.56 in

Gris claro

Light Grey

Gris clair



# Fundas / Covers / Housses

Consultar Departamento Comercial estoc disponible y tiempos de entrega.  
 Ask Sales Department available stock and delivery times.  
 Consulter le Département Commercial stock disponible et temps de livraison.

Material: 100% poliéster de 280 g/m2.

Características:

- Lavable
- No necesita plancha
- No encoje
- Colocación rápida y fácil
- Adaptable a todas las sillas y mesas de catering de **Resol Contract**.

Material: 100% polyester of 280 g/m2.

Characteristics:

- Washable
- Does not need ironing
- Shrinkproof
- Rapid and easy fitting
- Adaptable to all of the catering chairs and tables of **Resol Contract**.

Matériau: 100% Polyester de 280 g/m<sup>2</sup>.

Caractéristiques:

- Lavable
- Aucun repassage
- Ne rétrécit pas
- Pose rapide et facile
- Adaptable à toutes les chaises et tables de restauration de **Resol Contract**.

## Funda Garrotxa sin tablón Garrotxa cover without plank Housse Garrotxa sans planche



## Funda Garrotxa con tablón Garrotxa cover with plank Housse Garrotxa avec planche



## Funda Amadeus con tablón Amadeus cover with plank Housse Amadeus avec planche





**Funda Ópera con tablón**  
 Ópera cover with plank  
 Housse Ópera avec planche



					
Blanco White Blanc	Marfil Ivory Ivoire	Burdeos Burgundy Bordeaux	Azul Blue Bleu	Oro Gold Or	Negro Black Noir

**Funda Kurt con tablón**  
 Kurt cover with plank  
 Housse Kurt avec planche



					
Blanco White Blanc	Marfil Ivory Ivoire	Burdeos Burgundy Bordeaux	Azul Blue Bleu	Oro Gold Or	Negro Black Noir

**Lazo Garrotxa / Kurt**  
 Ribbon Garrotxa / Kurt  
 Noeud Garrotxa / Kurt



Blanco  
White  
Blanc

Marfil  
Ivory  
Ivoire

Burdeos  
Burgundy  
Bordeaux

Azul  
Blue  
Bleu

Oro  
Gold  
Or







Lazo Amadeus / Ópera  
 Ribbon Amadeus / Ópera  
 Noeud Amadeus / Ópera



				
Blanco White Blanc	Marfil Ivory Ivoire	Burdeos Burgundy Bordeaux	Azul Blue Bleu	Oro Gold Or

Lazo Tira Kurt  
 Ribbon Tira Kurt  
 Nœud Tira Kurt



						
Blanco White Blanc	Marfil Ivory Ivoire	Burdeos Burgundy Bordeaux	Azul Blue Bleu	Oro Gold Or	Negro Black Noir	Piedra Stone Pierre

Cabezal  
 Mall pillow  
 Avant-train



				
Blanco White Blanc	Marfil Ivory Ivoire	Burdeos Burgundy Bordeaux	Azul Blue Bleu	Oro Gold Or





# Vilagrasa

Desde 1957 existe en Vilagrasa la preocupación por las personas y su entorno. Es por ello que el diseño de nuestros productos responde a sus usuarios y sus usos, cualquiera que sea el espacio en el que se desenvuelvan.

Los productos de Vilagrasa ofrecen a las personas la posibilidad de conferir su propio sello de identidad al espacio en el que se emplazan, porque son el resultado de un minucioso análisis de las necesidades que deben satisfacer en ese espacio. Mantener limpio un aeropuerto o perfectamente ordenada una mesa de despacho, organizar un guardarropía de forma eficiente o facilitar la exhibición del impacto publicitario y los documentos de promoción en un espacio comercial, son algo más que simples funciones. Son una forma de interrelacionar la arquitectura y las personas, y en ese sentido nuestros productos contribuyen a convertir el edificio en un lugar más humano, más allá de un conjunto de paredes, muebles y máquinas. Productos creados por prestigiosos diseñadores que colaboran estrechamente con la firma.

Vilagrasa exporta sus productos a más de 22 países y lleva a cabo proyectos por todo el mundo.

Since 1957 Vilagrasa have maintained a constant concern for people and their environment. That is why the design of products therefore responds to their users and uses, whatever the place for which they are developed.

Vilagrasa's products offer people the chance to confer their own seal of identity to the places where they are used because they are the result of a detailed analysis of the needs that they must satisfy in the place. To keep an airport clean or an office table tidy, to efficiently organise a wardrobe or the exhibition of the advertising impact and promotional documents in a commercial space, are something more than just simple functions. They are a way to interrelate architecture and people, and in this sense our products contribute to converting a building into a place that is more human, not just a set of walls, furniture and machines. Collections that are the result of a product strategy based on close collaboration with prestigious designers.

Vilagrasa export its products to more than 22 countries and carry out projects all around the world.

Depuis 1957, Vilagrasa s'intéresse aux personnes et à leur environnement. C'est dans cette optique que le design de nos produits répond aux utilisateurs et à leurs usages, quel que soit l'espace dans lequel ils sont installés.

Les produits Vilagrasa apportent une touche personnelle au lieu auxquels ils sont destinés puisqu'ils sont le résultat d'une minutieuse analyse des besoins que représente celui-ci. Maintenir la propreté d'un aéroport ou l'ordre sur un bureau, organiser un vestiaire de manière efficace ou faciliter l'affichage publicitaire et promotionnel dans un espace commercial, sont ici bien plus que de simples fonctions. C'est pour nous le défi de créer un lien entre l'architecture et l'être humain, et dans ce sens contribuer à ce que nos produits convertissent un bâtiment en un lieu plus humain, au-delà des murs, des meubles et des machines. Nos produits sont créés par de prestigieux designers qui travaillent en étroite collaboration avec la maison Vilagrasa.

Vilagrasa exporte ses produits vers plus de 22 pays et collabore sur des projets à niveau international.

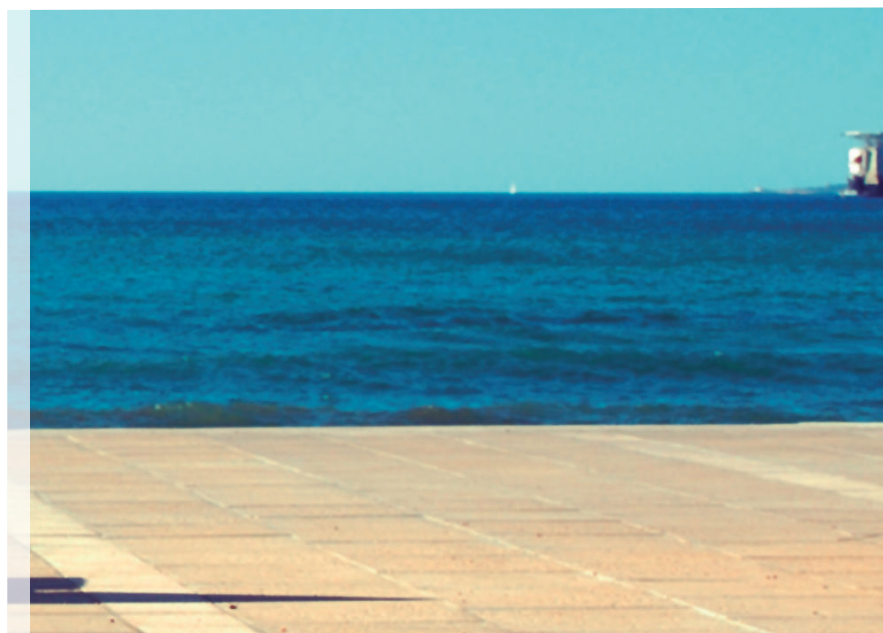

### Papeleras

#### Bins

#### Déchets

Bas 1002/1003 .....	264
Bas 1020/1021 .....	264
Bas 1022 .....	264
Mercuri .....	265
Mercuri Out .....	265
Fenix .....	266
Artria .....	266
Moai .....	268
Delta .....	268
Opal .....	268
Giro .....	270
Bas 1050/1051 .....	270
Basic .....	272
Bas 1001/1004 .....	272
Bas 1005/06/07/10 .....	273
Bas 1015/16/17 .....	273

### Ceniceros

#### Ashtrays

#### Cendriers

Columbia .....	274
Etna .....	274
Bilbo .....	275

### Bancos

#### Bench

#### Bancs

Berta .....	276
Matrix .....	277
Boomerang .....	277
Vela .....	280
Cetrus .....	280
Norma .....	282
Nilo .....	282
Disk .....	283
City .....	283

### Jardineras

#### Flower pot

#### Jardinière

Meeting point .....	284
Mall .....	284
Berta .....	285
Scoop .....	285
Rail .....	286

### Señalética

#### Signage

#### Signalétique

Roomie .....	288
Index .....	289
Cua .....	290
Bas3001/02/03/04 .....	291

### Atriles

#### Lectern

#### Lutrin

Levo .....	292
Arc .....	292

### Percheros

#### Coat hangers

#### Porte manteaux

Fargo .....	293
Bas 4500 .....	294
Kit .....	294



DELTA DE ORO  
1999



papelera / bin / dechet

## Bas 1002/1003

DESIGNED BY BAS STUDIO



Cuerpo en acero inoxidable o acero pintado. Aro superior basculante en acero inoxidable. Cubeta galvanizada. Uso interior en zonas comunes.

Stainless steel or painted steel body with a tilting lind in stainless steel. Galvanised liner. Indoor use in public spaces.

Corps en acier inoxydable ou acier peint. Couvercle supérieur basculant en acier inoxydable. Seau intérieur en acier galvanisé. Usage intérieur aux zones communes.

Ref.	Units STD	Packaging Dimensions (cm)	m3/ pack	NW Unit (kg)	Units Container 20'	Units Container 40'	Units Container HC	Units Traylor (70m3)	Units Truck 100m3
BAS-1002	12	40x40x75	0,12	11	132	300	-	396	456
BAS-1003	18	32x32x67	0,069	7	198	450	-	594	684

### 1 BAS-1002

Cap. 56 L ø 38 x H 73 cm

Cap. 14.8 gal. ø 15 x H 28-3/4 in



### 2 BAS-1003

Cap. 24 L ø 30 x H 65 cm

Cap. 6.3 gal. ø 11-13/16 x H 25-9/16 in

Inox brillante/Inox satinado

Shiny Inox/Satin Inox

Inox Brillant/Inox satin

Inox brillante/Negro

Shiny Inox/Black

Inox Brillant/Noir

papelera / bin / dechet

## Bas 1020/1021

DESIGNED BY BAS STUDIO



Cuerpo y aro superior en aluminio. Uso interior en zonas comunes.

Aluminium body and top. Indoor use in public spaces.

Corps et couvercle en aluminium. Usage intérieur aux zones communes.

Ref.	Units STD	Packaging Dimensions (cm)	m3/ pack	NW Unit (kg)	Units Container 20'	Units Container 40'	Units Container HC	Units Traylor (70m3)	Units Truck 100m3
BAS-1020	12	35x35x77	0,094	7	132	300	-	396	456
BAS-1021	8	47x47x88	0,194	12	80	176	-	208	240

### 1 BAS-1020

Cap. 47,5 L ø 32,1 x H 70 cm

Cap. 12.5 gal. ø 12-5/8 x H 27-9/16 in



### 2 BAS-1021

Cap. 114 L ø 45 x H 82,5 cm

Cap. 30.1 gal. ø 17-3/4 x H 32-1/2 in

Aluminio

Aluminium

Aluminium

papelera / bin / dechet

## Bas 1022

DESIGNED BY BAS STUDIO



Cuerpo y aro superior en aluminio. Cubetas en ABS. Uso interior en zonas comunes.

Aluminium body and top. Comes with two ABS liners. Indoor use in public spaces.

Corps et couvercle en aluminium. Bac intérieur en ABS. Usage intérieur aux zones communes.

Ref.	Units STD	Packaging Dimensions (cm)	m3/ pack	NW Unit (kg)	Units Container 20'	Units Container 40'	Units Container HC	Units Traylor (70m3)	Units Truck 100m3
BAS-1022	8	47x47x880	0,194	12	80	176	-	208	240

### BAS-1022

Cap. 100 L ø 44,7 x H 82,3 cm

Cap. 26.4 gal. ø 17-5/8 x H 32-7/16 in



Aluminio

Aluminium

Aluminium

papelera / bin / dechet

# Mercuri

DESIGNED BY GRUP BONAMUSA



Cuerpo en acero pintado o acero inoxidable. Tapas en perfil de aluminio. Uso interior y exterior en zonas comunes.

Body in painted steel or stainless steel. Lids are made of aluminium profiles. Indoor and outdoor use in public spaces.

Corps en acier peint ou acier inoxydable. Couvercle en profilé d'aluminium. Usage intérieur et extérieur aux zones communes.

Ref.	Units STD	Packaging Dimensions (cm)	m3/ pack	NW Unit (kg)	Units Container 20"	Units Container 40"	Units Container HC	Units Trayler (70m3)	Units Truck 100m3
MR-20	56	28x28x36	0,028	4	616	1.400	-	1.848	2.128
MR-30	88	15x15x80	-	5	968	2.200	-	2.904	3.344
MR-31	24	28x23x85	0,026	7	264	600	-	792	912
MR-32	24	28x23x85	0,041	7	264	600	-	792	912
MR-40	24	29x22x84	0,064	7	264	600	-	792	912
MR-60	10	36x36x108	0,133	11	110	250	-	330	380
MR-70	24	30x30x53	0,0392	7	264	600	-	792	912
MR-71	160	26x18x10	0,005	1	1.760	4.000	-	5.280	6.080

## MR-20

Papelera puesto de trabajo  
Workstation wastepaper basket  
Corbeille à papier poste de travail

1 **Cap. 15 L W 27,1 x L 20 x H 35 cm**  
**Cap. 4 gal. W 10-11/16 x L 7-7/8 x H 13-3/4 in**

## MR-30

Papelera con cenicero  
Wastepaper basket with ashtray  
Corbeilles avec cendrier

2 **Cap. 8 L W 13,3 x L 13 x H 73,7 cm**  
**Cap. 2.1 gal. W 5-1/4 x L 5-1/8 x H 29 in**

## MR-31

Papelera con cenicero  
Wastepaper basket with ashtray  
Corbeille avec cendrier

**Cap. 12 L W 13,3 x L 18 x H 73,7 cm**  
**Cap. 3.2 gal. W 5-1/4 x L 7-1/16 x H 29 in**

## MR-32

Papelera con cenicero  
Wastepaper basket with ashtray  
Corbeille avec cendrier

**Cap. 16 L W 13 x L 25 x H 120 cm**  
**Cap. 4.2 gal. W 5-1/8 x L 9-13/16 x H 29 in**

## MR-40

Papelera  
Wastepaper basket  
Corbeille

**Cap. 24 L W 15 x L: 27,1 x H 70 cm**  
**Cap. 6.2 gal. W 10-11/16 x L 5-7/8 x H 27-9/16 in**

## MR-60

Papelera individual  
Single wastepaper basket  
Corbeille individuelle

**Cap. 52 L W 27,1 x L: 25,6 x H 86 cm**  
**Cap. 13.8 gal. W 10-11/16 x L 10-1/16 x H 33-7/8 in**

## MR-70 + MR-71

Paraguero + Accesorio paraguas pequeños  
Umbrella stand + Accessory for small umbrellas  
Porte parapluies + Accessoire pour petits parapluies

**W 28 x L 28 x H 50 cm**  
**W 11 x L 11 x H 19-11/16 in**



Ral 9006



Antracita



Aluminio

Ral 9006

Anthracite

Aluminium

Ral 9006

Anthracite

Aluminium

papelera / bin / dechet

# Mercuri out

DESIGNED BY GRUP BONAMUSA



Estructura: aluminio. Cubetas: Acero inoxidable satinado. El cenicero circular dispone de una cubeta interior fabricada en aluminio pintada. Arena incluida. Uso interior y exterior en zonas comunes.

Struture in aluminium. Basket: satin stainless steel. The circular ashtray has a liner made of painted aluminium. Sand included. Indoor and outdoor use in public spaces.

Structure: aluminium. Corbeilles: acier inoxydable satiné. Le cendrier circulaire dispose d'une cuvette intérieure en aluminium peinte. Sable inclus. Usage intérieur et extérieur aux zones communes.

Ref.	Units STD	Packaging Dimensions (cm)	m3/ pack	NW Unit (kg)	Units Container 20"	Units Container 40"	Units Container HC	Units Trayler (70m3)	Units Truck 100m3
MR-01	24	33x20x68	0,045	11	264	600	-	792	912
MR-05	12	43x22x95	0,09	17	132	300	-	396	456

## MR-01

Papelera mural con cenicero  
Wall-mounted wastepaper basket with ashtray  
Corbeille murale avec cendrier

**Cap. 17 L W 17,7 x L 32,2 x H 62,3 cm**  
**Cap. 4,5 gal. W 6-15/16 x L 12-11/16 x H 24-1/2 in**

## MR-05

Papelera de pie con cenicero  
Free standing wastepaper basket with ashtray  
Corbeille sur pied avec cendrier

**Cap. 19 L W 17,7 x L 33,8 x H 86 cm**  
**Cap. 5 gal. W 6-15/16" x L 13-5/16 x H 33-7/8 in**



Ral 9006



Antracita



Aluminio

Ral 9006

Anthracite

Aluminium

Ral 9006

Anthracite

Aluminium



papelera / bin / dechet

# Fénix

DESIGNED BY I+D VILAGRASA



Cabezal y cuerpo: acero pintado o acero inoxidable. Papelera autoextinguible. Color personalizable.

Body and top in painted steel or stainless steel. Self-extinguishing wastepaper basket.

Tête et corps: acier peint ou acier inoxydable. Corbeille auto-extinction.

Ref.	Units STD	Packaging Dimensions (cm)	m3/ pack	NW Unit (kg)	Units Container 20'	Units Container 40'	Units Container HC	Units Trayler (70m3)	Units Truck 100m3
FÉNIX-1	56	28x27x37	0,028	3	616	1.400	-	1.848	2.128
FÉNIX-2	24	29x29x51	0,043	4	264	600	-	792	912
FÉNIX-3	8	44x44x88	0,043	7	88	200	-	264	304

## 1 FÉNIX-1

Papelera autoextinguible  
Self-extinguishing wastepaper basket  
Corbeille auto-extinction

**Cap.** 11 L  $\phi$  25,3 x H 32,1 cm

**Cap.** 2.9 gal.  $\phi$  9-15/16 x H 12-5/8 in

## 2 FÉNIX-2

Papelera autoextinguible  
Self-extinguishing wastepaper basket  
Corbeille auto-extinction

**Cap.** 22 L  $\phi$  27,1 x H 48,1 cm

**Cap.** 5.8 gal.  $\phi$  11 x H 18-15/16 in

## 3 FÉNIX-3

Papelera autoextinguible  
Self-extinguishing wastepaper basket  
Corbeille auto-extinction

**Cap.** 50 L  $\phi$  36 x H 64,8 cm

**Cap.** 13.2 gal.  $\phi$  14-3/16 x H 25-1/2 in



Gris metalizado

Metallic grey

Gris métallisé



Antracita

Anthracite

Anthracite



Blanco

White

Blanc



Inox satinado

Inox satin

Inox satiné

papelera / bin / dechet

# Artria

DESIGNED BY TEC STUDIO



Cuerpo en acero pintado o en acero inoxidable. Aro y gorro superior en fundición de aluminio. Soporte suelo en hormigón. Color personalizable. Uso exterior.

Steel painted or Stainless Steel body. Ring top and head in casted aluminium. Base made of concrete. Outdoor use.

Corps en acier peint ou en acier inoxydable. Anneau et couvercle supérieur en fonte d'aluminium. Support sol en béton. Usage extérieur.

Ref.	Units STD	Packaging Dimensions (cm)	m3/ pack	NW Unit (kg)	Units Container 20'	Units Container 40'	Units Container HC	Units Trayler (70m3)	Units Truck 100m3
ARTRIA-01	2	54x53x113	0,12	51	22	50	-	66	76
ARTRIA-02	2	54x53x113	0,12	52	22	50	-	66	76
ARTRIA-03	8	42x42x97	0,069	26	80	176	-	208	240

## 1 ARTRIA-01

Papelera con cabezal. Cubeta interior opcional Artria-04  
Wastepaper basket with top. Optional internal liner Artria-04  
Corbeille avec couvercle dôme. Bac intérieur en option Artria-04

**Cap.** 100 L **W** 54 x **L** 54 x **H** 120 cm

**Cap.** 26 gal. **W** 21-1/4 x **L** 21-1/4 x **H** 47-1/4 in

## 2 ARTRIA-02

Papelera con cabezal y cenicero  
Wastepaper basket with top and ashtray  
Corbeille avec couvercle dôme et cendrier

**Cap.** 100 L **W** 54 x **L** 54 x **H** 120 cm

**Cap.** 26 gal. **W** 21-1/4 x **L** 21-1/4 x **H** 47-1/4 in

## 3 ARTRIA-03

Papelera con aro  
Wastepaper basket without top  
Corbeille avec anneau

**Cap.** 50 L **W** 40 x **L** 40 x **H** 80 cm

**Cap.** 12.2 gal. **W** 15-3/4 x **L** 15-3/4 x **H** 31-1/2 in



Gris/Inox satinado

Grey/Inox satin

Gris/Inox satiné



Gris/Antracita

Grey/Anthracite

Grey/Anthracite



Gris/Azul

Grey/Blue

Grey/Bleu

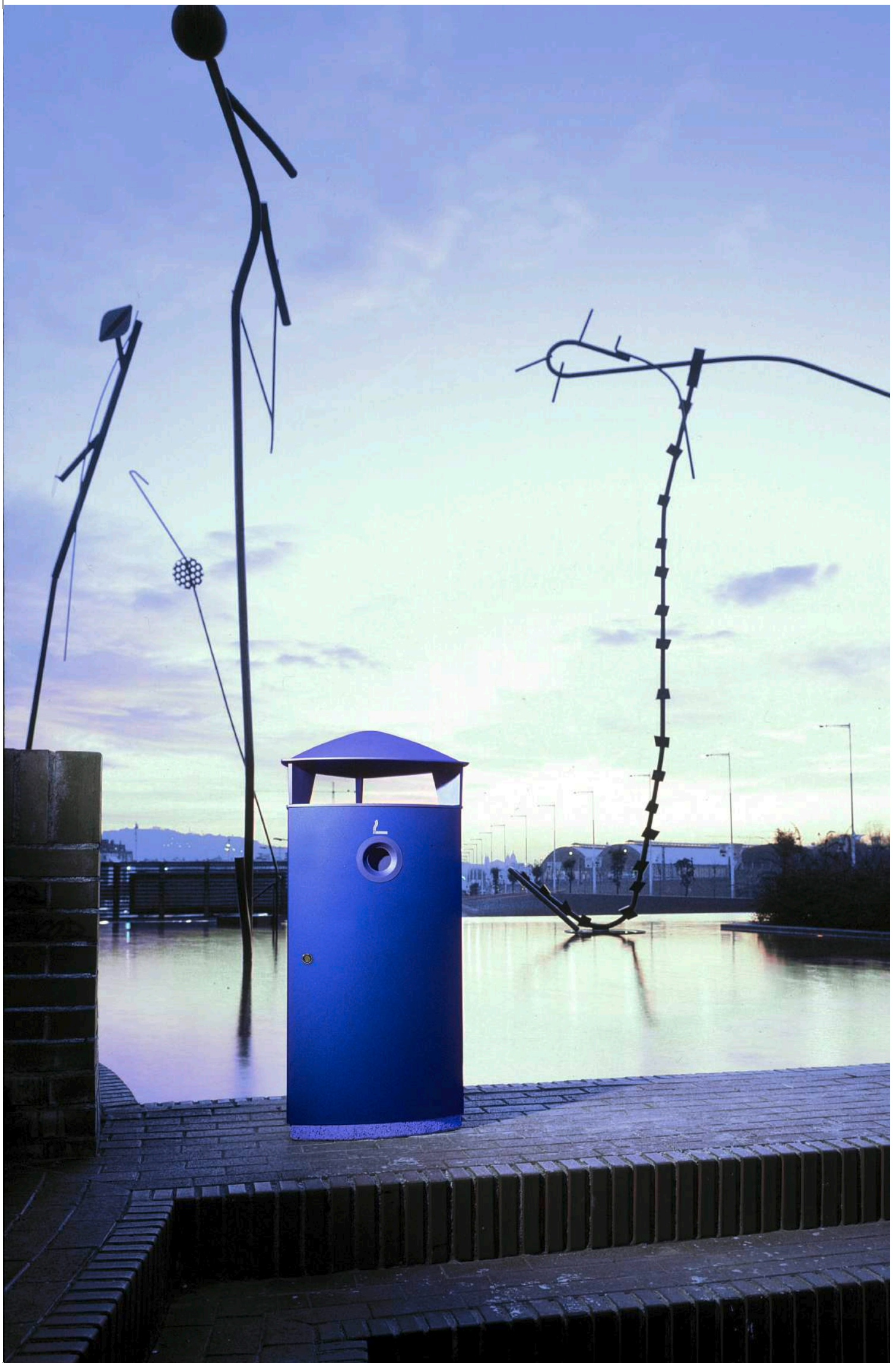

papelera / bin / dechet

# Moai

DESIGNED BY MAGMA DESIGN



Papelera gran capacidad. Cuerpo de polietileno y aro superior en fundición de aluminio. Color personalizable. Uso exterior.

Large-capacity wastepaper basket. Body of polyethylene with ring top in casted aluminium. Outdoor use.

Corbeille grande capacité. Corps en polyéthylène et anneau supérieur en fonte d'aluminium. Usage extérieur.

Ref.	Units STD	Packaging Dimensions (cm)	m3/ pack	NW Unit (kg)	Units Container 20'	Units Container 40'	Units Container HC	Units Trayler (70m3)	Units Truck 100m3
MOAI-01	4	64x64x94	0,385	15	44	96	-	120	132

## MOAI-01

Papelera gran capacidad  
Large-capacity wastepaper basket  
Corbeille grande capacité

**Cap.** 200 L  $\phi$  66,5 x H 94,2 cm

**Cap.** 52.8 gal.  $\phi$  26-3/16 x H 37-1/16 in



Antracita/Jaspeado  
Anthracite/marbling  
Anthracite/persillage

papelera / bin / dechet

# Delta

DESIGNED BY FRANC FERNÁNDEZ / KX DESIGNERS



Papelera con zócalo. Cuerpo de aluminio extrusionado y aro en fundición de aluminio. Uso exterior.

Wastepaper basket with base. Extruded aluminium body with top ring in cast aluminium. Outdoor use.

Corbeille sur socle. Corps en aluminium extrudé et anneau supérieur en fonte d'aluminium. Usage extérieur.

Ref.	Units STD	Packaging Dimensions (cm)	m3/ pack	NW Unit (kg)	Units Container 20'	Units Container 40'	Units Container HC	Units Trayler (70m3)	Units Truck 100m3
DELTA-01	8	44x44x96	0,186	19	80	176	-	208	204

## DELTA-01

Papelera con zócalo  
Wastepaper basket with base  
Corbeille sur socle

**Cap.** 55 L  $\phi$  36 x H 89,2 cm

**Cap.** 14.5 gal.  $\phi$  14-3/16x H 35-1/8 in



Antracita  
Anthracite  
Anthracite



Gris  
Grey  
Gris

papelera / bin / dechet

# Opal

DESIGNED BY SERGI FERNÁNDEZ



Papelera batiente con cenicero. Cuerpo, gorro y patas en acero pintado. Aro en fundición de aluminio. Uso exterior.

Tilting wastepaper basket with ashtray. Body, head and legs made of painted steel. Top ring in casted aluminium. Outdoor use.

Corbeille basculante et cendrier. Corps, couvercle et piètement en acier peint. Anneau supérieur en fonte d'aluminium. Usage extérieur.

Ref.	Units STD	Packaging Dimensions (cm)	m3/ pack	NW Unit (kg)	Units Container 20'	Units Container 40'	Units Container HC	Units Trayler (70m3)	Units Truck 100m3
OPAL-02	7	57x31x110	0,187	35	70	154	-	182	210

## OPAL-02

Papelera batiente con cenicero  
Tilting wastepaper basket with ashtray  
Corbeille basculante et cendrier

**Cap.** 50 L **W** 53,5 x **L** 27 x **H** 106,4 cm

**Cap.** 13,2 gal. **W** 21-1/16 x **L** 10-5/8 x **H** 47-7/8 in



Antracita  
Anthracite  
Anthracite





papelera / bin / dechet

# Giro

DESIGNED BY JORDI BLASI



Poliétileno rotacional con protección UV. Giro-3, Giro-11 y Giro-33 con contrapeso de hormigón. Uso exterior.

Rotomoulded polyethylene protected against UV radiation. Giro-3, Giro-11 and Giro-33, has a concrete weigh base. Outdoor use.

Polyéthylène rotomoulé - Protection UV. Contrepoids en béton pour la Giro-3, Giro-11 et Giro-33. Usage extérieur.

Ref.	Units STD	Packaging Dimensions (cm)	m3/pack	NW Unit (kg)	Units Container 20'	Units Container 40'	Units Container HC	Units Traylor (70m3)	Units Truck 100m3
GIRO-01	4	65x65x97	0,397	8	44	96	-	120	132
GIRO-02	2	65x65x122	0,603	11	22	48	-	60	66
GIRO-03	2	65x65x100	0,435	38	22	48	-	60	66

## 1 GIRO-01

Papelera de boca superior con cerradura  
Top opening wastepaper basket  
Corbeille avec ouverture supérieure

**Cap.** 165 L **ø** 68 x **H** 96 cm

**Cap.** 43.6 gal. **ø** 26-3/4 x **H** 26-3/4 in

## 2 GIRO-02

Papelera de boca superior empotrable con cerradura  
Top opening wastepaper basket built in  
Corbeille avec ouverture supérieure encastrable avec serrure

**Cap.** 165 L **ø** 68 x **H** 121,5 cm

**Cap.** 43.6 gal. **ø** 26-3/4 x **H** 47-13/16 in

## 3 GIRO-03

Papelera de dos bocas frontales con cerradura  
2 front openings wastepaper basket  
Corbeille avec deux ouvertures de face

**Cap.** 120 L **ø** 68 x **H** 100 cm

**Cap.** 31.7 gal. **ø** 26-3/4 x **H** 39-3/8 in

## GIRO-11

Papelera de boca superior sin cerradura  
Top opening wastepaper basket  
Corbeille avec ouverture supérieure

**Cap.** 165 L **ø** 68 x **H** 96 cm

**Cap.** 43.6 gal. **ø** 26-3/4 x **H** 26-3/4 in

## GIRO-33

Papelera de dos bocas frontales sin cerradura  
2 front openings wastepaper basket  
Corbeille avec deux ouvertures de face

**Cap.** 120 L **ø** 68 x **H** 100 cm

**Cap.** 31.7 gal. **ø** 26-3/4 x **H** 39-3/8 in



Azul  
Blue  
Bleu



Amarillo  
Yellow  
Jaune



Gris  
Grey  
Gris



Negro reciclado  
Black recycled  
Noir recyclé

papelera / bin / dechet

# Bas 1050/1051

DESIGNED BY BAS STUDI



Cuerpo, boca y accesorio reciclaje en plástico inyectado. Color personalizable. Uso en oficinas y habitaciones.

The whole item and its components are made of injected plastic. Use in offices and bedrooms.

Corps, couvercle et accessoires tri en plastique injecté. Usage en bureaux et chambres.

Ref.	Units STD	Packaging Dimensions (cm)	m3/pack	NW Unit (kg)	Units Container 20'	Units Container 40'	Units Container HC	Units Traylor (70m3)	Units Truck 100m3
BAS-1050	128	-	-	1	1.280	2.816	-	3.328	3.840
BAS-1051	96	-	-	1	960	2.112	-	2.496	2.880

## 1 BAS-1050

**Cap.** 10 L **ø** 22,5 x **H** 27,5 cm

**Cap.** 2.6 gal. **ø** 8-7/8 x **H** 10-13/16 in

## 2 BAS-1051

**Cap.** 17 L **ø** 22,5 x **H** 36 cm

**Cap.** 4.5 gal. **ø** 9-13/16 x **H** 14-3/16 in



Negro  
Black  
Noir





Regidoria Platges

**Atenció!**  
Una de les característiques naturals del riuert termal, és la presència d'algues microscòpiques. Per tant, cal que tingueu molta cura a l'hora d'entrar al riuert perquè hi podeu rrelliscar.



papelera / bin / dechet

# Basic

DESIGNED BY BAS STUDI



Colección de papeleras de puesto de trabajo. Acabados: Acero pintado y opcionalmente acero inoxidable. Uso en oficinas y habitaciones.

Workstation paper basket collection. Finishes are of painted steel. As an option, they could be done in stainless steel. Use in offices and bedrooms.

Collection de cobeilles à papier pour poste de travail. Finitions: acier peint. Acier Inoxydable optionnel. Usage en bureaux et chambres.

Ref.	Units STD	Packaging Dimensions (cm)	m3/ pack	NW Unit (kg)	Units Container 20'	Units Container 40'	Units Container HC	Units Trayler (70m3)	Units Truck 100m3
P-2200	56	28x27x37	-	6	616	1.400	1.400	1.848	2.128
P-2300	24	28x23x85	-	6	264	600	600	792	912
P-2050	36	29x29x51	-	4	396	900	900	1.188	1.188
P-2075	36	29x29x51	-	5	396	900	900	1.188	1.188
CB-3	56	28x27x37	-	2	616	1.400	1.400	1.848	1.848
CB-31	56	28x27x37	-	2	616	1.400	1.400	1.848	3.840
CB-20	56	28x27x37	-	3	616	1.400	1.400	1.848	1.848
CB-21	56	28x27x37	-	3	616	1.400	1.400	1.848	1.848

**1 P-2200**  
Papelera con aro superior  
Wastepaper basket with upper ring  
Corbeille à papier avec anneau supérieur

**Cap.** 14 L **Ø** 25,3 x **H** 33,8 cm  
**Cap.** 3.7 gal. **Ø** 10 x **H** 13-5/16 in

**2 P-2300**  
Papelera de pie con cenicero  
Standing wastepaper basket with ashtray  
Corbeille sur pied avec cendrier

**Cap.** 14 L **W** 22,5 x **L** 16 x **H** 66 cm  
**Cap.** 3.7 gal. **W** 8-7/8 x **L** 6-5/16 x **H** 26 in

**P-2050**  
Papelera con aro superior  
Wastepaper basket with upper ring  
Corbeille à papier avec anneau supérieur

**Cap.** 21 L **Ø** 27 x **H** 39 cm  
**Cap.** 5.6 gal. **Ø** 10-8/8 x **H** 15-3/8 in

**P-2075**  
Paraguero con aro superior  
Umbrella stand  
Porte-parapluies avec anneau supérieur

**Ø** 27 x **H** 49 cm  
**Ø** 10-5/8 x **H** 19-5/16 in

**CB-3**  
Papelera  
Wastepaper basket  
Corbeille à papier

**Cap.** 14 L **Ø** 25,3 x **H** 32,5 cm  
**Cap.** 3.7 gal. **Ø** 9-15/16 x **H** 12-11/16 in

**CB-31**  
Papelera con aro portabolsas  
Wastepaper basket with upper ring  
Corbeille à papier avec anneau porte-sacs

**Cap.** 14 L **Ø** 25,3 x **H** 32,5 cm  
**Cap.** 3.7 gal. x **Ø** 10 x **H** 12-13/16 in

**3 CB-20**  
Papelera  
Wastepaper basket  
Corbeille à papier

**Cap.** 14 L **Ø** 24,5 x **H** 31,9 cm  
**Cap.** 3.7 gal. x **Ø** 9-15/16 x **H** 12-13/16 in

**CB-21**  
Papelera con aro portabolsas  
Wastepaper basket with upper ring  
Corbeille à papier avec anneau porte-sacs

**Cap.** 14 L **Ø** 25,3 x **H** 32,1 cm  
**Cap.** 3.7 gal. **Ø** 9-15/16 x **H** 12-5/8 in

papelera / bin / dechet

# Bas 1001/1004

DESIGNED BY BAS STUDI



VILAGRASA

Cuerpo en acero pintado o acero inoxidable. Aro BAS 1004 acero inoxidable. Uso en oficinas y habitaciones.

Stainless steel or r painted steel body. The top ring in the Bas 1004 is stainless steel. Use in offices and bedrooms.

Corps acier peint ou en acier inoxydable. Anneau BAS 1004 acier inoxydable. Usage en bureaux et chambres.

Ref.	Units STD	Packaging Dimensions (cm)	m3/ pack	NW Unit (kg)	Units Container 20'	Units Container 40'	Units Container HC	Units Trayler (70m3)	Units Truck 100m3
BAS-1001	64	23x23x31	0,016	1	704	1.600	-	2.112	2.432
BAS-1004	81	27x27x32	0,021	1	810	1.782	-	2.106	2.430

**1 BAS-1001**  
**Cap.** 10 L **Ø** 23 x **H** 30 cm  
**Cap.** 2.6 gal. **Ø** 9-1/16 x **H** 11-13/16 in

**2 BAS-1004**  
**Cap.** 14 L **Ø** 24,5 x **H** 30 cm  
**Cap.** 3.7 gal. **Ø** 9-11/16 x **H** 11-13/16 in



papelera / bin / dechet

# Bas 1005/06/07/10

DESIGNED BY BAS STUDI

Cuerpo y tapa de acero inoxidable. Cubeta interior en ABS. Sistema apertura pedal. Uso en baños y cocinas.

Lid and Body in stainless steel containing an ABS liner. Foot pedal opening. Use in bathrooms and kitchens.

Corps et couvercle acier inoxydable. Bac intérieur en ABS. Système ouverture à pédales. Usage en salles de bain et cuisines



Units Ref.	Units STD	Packaging Dimensions (cm)	m3/ pack	NW Unit (kg)	Units Container 20'	Units Container 40'	Units Container HC	Units Trayler (70m3)	Units Truck 100m3
BAS-1005	168	19x19x25	0,009	1	1.848	4.200	-	5.544	6.384
BAS-1006	24	22x22x27	0,013	3	240	528	-	624	720
BAS-1007	32	27x26x41	0,029	2	352	800	-	1.056	1.216
BAS-1010	32	33x30x47	-	3	352	800	-	1.056	1.216

- 1 BAS-1005  
Cap. 3 L  $\phi$  17 x H 24 cm  
Cap. 0.8 gal.  $\phi$  6-11/16 x H 9-7/16 in
- 2 BAS-1006  
Cap. 5 L  $\phi$  20,5 x H 25,5 cm  
Cap. 1.3 gal.  $\phi$  8-1/16 x H 10-1/16 in
- 3 BAS-1007  
Cap. 12 L  $\phi$  25,3 x H 40 cm  
Cap. 3.2 gal.  $\phi$  10 x H 15-3/4 in
- 4 BAS-1010  
Cap. 20 L  $\phi$  29,3 x H 45,5 cm  
Cap. 5.3 gal.  $\phi$  11-9/16 x H 17-15/16 in

Inox brillante  
Shiny Inox  
Inox Brillant

papelera / bin / dechet

# Bas 1015/16/17

DESIGNED BY BAS STUDI

Cuerpo y tapa de acero inoxidable . Cubeta interior en ABS. Sistema apertura pedal. Uso en baños y cocinas.

Lid and Body in stainless steel containing an ABS liner. Foot pedal opening. Use in bathrooms and kitchens.

Corps et couvercle acier inoxydable. Bac intérieur en ABS. Système ouverture à pédales. Usage en salles de bain et cuisines



Units Ref.	Units STD	Packaging Dimensions (cm)	m3/ pack	NW Unit (kg)	Units Container 20'	Units Container 40'	Units Container HC	Units Trayler (70m3)	Units Truck 100m3
BAS-1015	78	22x22x23	0,397	1	858	1.950	-	2.574	2.964
BAS-1016	32	27x27x48	0,603	3	352	800	-	1.056	1.216
BAS-1017	15	38x38x73	0,435	6	165	375	-	495	570

- 1 BAS-1015  
Cap. 6 L W 23,5 x L 23 x H 36,5 cm  
Cap. 1.6 gal. W 9-1/4 x L 9-1/16 x H 14-3/8 in
- 2 BAS-1016  
Cap. 10 L W 29,6 x L 26 x H 45 cm  
Cap. 2.6 gal. W 11-11/16 x L 10-1/4 x H 17-3/4 in
- 3 BAS-1017  
Cap. 30 L W 37,5 x L 34 x H 69 cm  
Cap. 7.9 gal. W 14-3/4 x L 13-3/8 x H 27-3/16 in

Inox satinado  
Satin Inox  
Inox satin

cenicero / ashtray / cendrier

# Columbia

DESIGNED BY I+D VILAGRASA



Cabezal: pintado poliéster o acero inoxidable satinado con cubeta de aluminio.  
Columna: acero inoxidable. Base: fundición pintada.

Top polyester painted or satin stainless steel with aluminum liner. Pole: stainless steel.  
Base: painted cast.

Tête : peinture polyester noir ou acier inoxydable satiné avec seau en aluminium.  
Colonne: acier inoxydable. Base: fonte peinte.

Ref.	Units STD	Packaging Dimensions (cm)	m3/ pack	NW Unit (kg)	Units Container 20'	Units Container 40'	Units Container HC	Units Trayler (70m3)	Units Truck 100m3
M-1200/1	24	28x23x85	0,055	8	264	600	-	792	912
M-1200/2	24	28x23x85	0,054	10	264	600	-	792	912
M-1100/2	240	20,5x20,5x14,5	0,007	3	2.400	5.280	-	6.240	7.200

## 1 M-1100/1

Cenicero mural con apagador  
Wall-mounted ashtray with cigarette extinguishing device  
Cendrier mural avec éteignoir

Ø 16 x H 13 cm  
Ø 6-5/16 x H 5-1/8 in

## M-1100/2

Cenicero mural con arena  
Wall-mounted ashtray with sand  
Cendrier mural avec sable

Ø 16 x H 13 cm  
Ø 6-5/16 x H 5-1/8 in

## 2 M-1200/1

Cenicero de pie con apagador  
Free standing ashtray with cigarette extinguishing device  
Cendrier sur pied avec éteignoir

Ø 16 x H 79 cm  
Ø 6-5/16 x H 31-1/8 in

## M-1200/2

Cenicero de pie con arena  
Free standing ashtray with sand  
Cendrier sur pied avec sable

Ø 16 x H 79 cm  
Ø 6-5/16 x H 31-1/8 in



Negro  
Black  
Noir



Inox satinado  
Satin Inox  
Inox satin

cenicero / ashtray / cendrier

# Etna

DESIGNED BY JOSEP LLUSCA



Cenicero mesa: cromado-cristal ácido. Cenicero de pie y pared: cromado-pintado.

Table ashtray: chromed steel and sandblasted glass. Stand and wall mounted ashtrays: chromed and painted steel.

Cendrier de table: chromé et verre acide. Cendrier sur pied et mural: chromé et peint.

Ref.	Units STD	Packaging Dimensions (cm)	m3/ pack	NW Unit (kg)	Units Container 20'	Units Container 40'	Units Container HC	Units Trayler (70m3)	Units Truck 100m3
ETNA-1	770	17x16x6,5	0,003	1	8.470	19.250	-	25.410	29.260
ETNA-3	24	28x23x85	0,052	3	264	600	-	792	912
ETNA-41.200		18x8x8	0,001	1	13.200	30.000	-	39.600	45.600

## ETNA-1

Cenicero de sobremesa  
Table ashtray  
Cendrier de table

W 7,6 x L 7,6 x H 4,4 cm  
W 3 x L 3 x H 1-3/4 in

## 1 ETNA-3

Cenicero de pie con base  
Free standing ashtray with base  
Cendrier sur pied avec base

W 18 x L 18 x H 71,1 cm  
W 7-1/16 x L 7-1/16 x H 28 in

## ETNA-4

Cenicero mural  
Wall-mounted ashtray  
Cendrier mural

W 7 x L 7,5 x H 17,7 cm  
W 2-3/4 x L 2-15/16 x H 6-15/16 in



Ral 9006  
Ral 9006  
Ral 9006



Antracita  
Anthracite  
Anthracite



Cromado translúcido  
Translucent chrome  
Chrome translucide



cenicero / ashtray / cendrier

# Bilbo

DESIGNED BY I+D VILAGRASA



Cuerpo en acero pintado y cabezal en fundición de aluminio. Apagador y cubeta interior en acero galvanizado. Color personalizado.

Steel painted body with head of casted aluminium. It also include a galvanised steel liner and extinguisher.

Corps en acier peint et tête en fonte d'aluminium. Éteignoir et récipient intérieur en acier galvanisé.

Ref.	Units STD	Packaging Dimensions (cm)	m3/ pack	NW Unit (kg)	Units Container 20'	Units Container 40'	Units Container HC	Units Traylor (70m3)	Units Truck 100m3
BILBO-01	120	12x13x103	0,397	7	1.320	3.000	-	3.960	4.560
BILBO-02	180	12x13x65	0,603	7	1.980	4.500	-	5.940	6.840
BILBO-03	10	32x28x110	0,435	12	110	250	-	330	380

## 1 BILBO-01

Cenicero de pie  
Free standing ashtray  
Cendrier sur pied

**Cap.** 1,1 L  $\phi$  10,4 x H 100 cm

**Cap.** 2.9 gal.  $\phi$  4-1/16 x H 39-3/8 in

## 2 BILBO-02

Cenicero mural  
Wall mounted ashtray  
Cendrier mural

**Cap.** 1,1 L  $\phi$  10,4 x 12,1 x H 49,7 cm

**Cap.** 2.9 gal.  $\phi$  4-1/16 x 4-3/4 x H 19-9/16 in

## 3 BILBO-03

Cenicero autoportante  
Self-carrying ashtray  
Cendrier autoportant

**Cap.** 1,1 L  $\phi$  21 x H 103,3 cm

**Cap.** 2.9 gal.  $\phi$  8-1/4 x H 40-11/16 in



Antracita  
Anthracite  
Anthracite

**Cap.** Capacidad / Capacity / Capacité  **$\phi$** : diámetro / diameter / diamètre **H**: altura / height / hauteur



banco / bench / banc

# Berta

DESIGNED BY FRANC FERNÁNDEZ / KX DESIGNERS

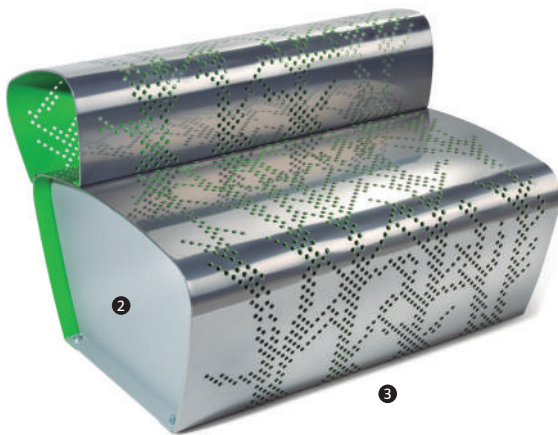

Asiento y respaldo en plancha de aluminio. Pintado interior a petición cliente. Tapas laterales en acero pintado. Color personalizado. Uso exterior.

Seat and backrest is of aluminium. Lateral lids are in painted steel. As an option the interior part could be painted. Corps en acier peint et tête en fonte d'aluminium. Outdoor use.

Assise et dossier en tôle d'aluminium. Sur demande, possibilité de peinture intérieure. Extrémités en acier peint. Usage extérieur.

Ref.	Units STD	Packaging Dimensions (cm)	m3/ pack	NW Unit (kg)	Units Container 20'	Units Container 40'	Units Container HC	Units Traylor (70m3)	Units Truck 100m3
BERTA-01	3	119x79x57	0,517	30	33	75	-	99	114
BERTA-02	3	119x79x57	0,531	21	33	75	-	99	114
BERTA-03	3	119x79x57	0,531	21	33	75	-	99	114

## 1 BERTA-01

Banco recto  
Straight bench  
Banc droit

**W** 100 x **L** 78 x **H** 45 cm

**W** 39-3/8 x **L** 30-11/16 x **H** 17-3/4 in

## BERTA-02

Banco sección izquierda  
Bench bevelled on the left  
Banc chanfreiné du côté gauche

**W** 100 x **L** 78 x **H** 45 cm

**W** 39-3/8 x **L** 30-11/16 x **H** 17-3/4 in

## BERTA-03

Banco sección derecha  
Bench bevelled on the right  
Banc chanfreiné du côté droit

**W** 100 x **L** 78 x **H** 45 cm

**W** 39-3/8 x **L** 30-11/16 x **H** 17-3/4 in

## 2 BERTA-04

Tapas finales  
End cover  
Couvercles aux extrémités

## 3 BERTA-05

Banco con respaldo  
Bench with backrest  
Banc à dossier

**W** 100 x **L** 90 x **H** 70 cm

**W** 39-3/8 x **L** 35-7/16 x **H** 27-9/16 in



Aluminio  
Aluminium  
Aluminium

**W:** ancho / width / largeur **L:** largo / length / longueur **H:** altura / height / hauteur





banco / bench / banc

# Matrix

DESIGNED BY VICENTE SOTO

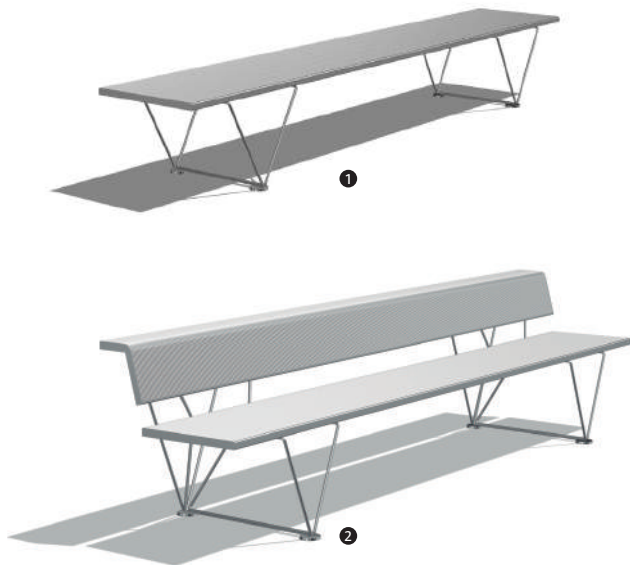

Aluminio/Inox brillante  
Aluminium/ Shiny Inox  
Aluminium/ Inox Brillant

## MATRIX-01

Bancada 3 plazas  
Three seats bench  
Banquette 3 places

**W** 201 x **L** 56,3 x **H** 42,6 cm  
**W** 79-1/8 x **L** 22-3/16 x **H** 16-3/4 in

## 1 MATRIX-02

Bancada 4 plazas  
Four seats bench  
Banquette 4 places

**W** 263,5 x **L** 56,3 x **H** 42,6 cm  
**W** 103-3/4 x **L** 22-3/16 x **H** 16-3/4 in

Estructura en acero inoxidable. Asiento y respaldo aluminio extrusionado. Cojines en asientos y respaldos opcionales semirígidos de poliuretano de alta densidad. Uso interior y exterior.

Stainless steel structure. Seat and backrest in extruded aluminium. Optional: upholstery seat and high density polyurethane semi-rigid back rest. Indoor and outdoor use.

Structure en acier inoxydable. Assise et dossier en aluminium extrudé. Option: coussins d'assise et de dossier semi-rigides en polyuréthane de haute densité. Usage intérieur et extérieur.

Ref.	Units STD	Packaging Dimensions (cm)	m3/ pack	NW Unit (kg)	Units Container 20'	Units Container 40'	Units Container HC	Units Trayler (70m3)	Units Truck 100m3
MATRIX-01	2	210x60x60	-	33	8	16	-	30	36
MATRIX-02	2	274x60x60	-	40	4	12	-	24	30
MATRIX-03	2	398x60x60	-	57	4	8	-	18	18
MATRIX-04	2	585x60x60	-	72	0	8	-	12	12
MATRIX-11	2	210x104x70	-	50	4	8	-	20	24
MATRIX-12	2	274x104x70	-	55	4	6	-	16	20
MATRIX-13	2	398x104x70	-	74	2	8	-	16	16
MATRIX-14	2	585x104x70	-	88	0	4	-	8	8

## MATRIX-03

Bancada 6 plazas  
Six seats bench  
Banquette 6 places

**W** 388,5 x **L** 56,3 x **H** 42,6 cm  
**W** 152-15/16 x **L** 22-3/16 x **H** 16-3/4 in

## MATRIX-04

Bancada 9 plazas  
Nine seats bench  
Banquette 9 places

**W** 576 x **L** 56,3 x **H** 42,6 cm  
**W** 226-3/4 x **L** 22-3/16 x **H** 16-3/4 in

## MATRIX-11

Banco 3 plazas  
Three seats backrest bench  
Banc 3 places

**W** 201 x **L** 65,2 x **H** 69,9 cm  
**W** 79-1/8 x **L** 25-11/16 x **H** 27-1/5 in

## 2 MATRIX-12

Banco 4 plazas  
Four seats backrest bench  
Banc 4 places

**W** 263,5 x **L** 65,2 x **H** 69,9 cm  
**W** 103-3/4 x **L** 25-11/16 x **H** 27-1/5 in

## MATRIX-13

Banco 6 plazas  
Six seats backrest bench  
Banc 6 places

**W** 388,5 x **L** 65,2 x **H** 69,9 cm  
**W** 152-15/16 x **L** 25-11/16 x **H** 27-1/5 in

## MATRIX-14

Banco 9 plazas  
Nine seats backrest bench  
Banc 9 places

**W** 576 x **L** 65,2 x **H** 69,9 cm  
**W** 226-3/4 x **L** 25-11/16 x **H** 27-1/5 in

## MATRIX-90

Cojín bancada  
Pad bench  
Coussin banquette

**W** 50 cm  
**W** 19-11/16 in

## MATRIX-91

Cojín banco  
Pad backrest bench  
Coussin banc

**W** 50 cm  
**W** 19-11/16 in

banco / bench / banc

# Boomerang

DESIGNED BY VICENTE SOTO



Banco en fibra de vidrio con resina de poliéster no saturado. Opción ignífuga consultar. Uso interior y exterior.

Non swamped polyester gum fiber glass bench. Optional: Fire-retardant version. Indoor and outdoor use.

Banc en fibre de verre et résine de polyester non saturé. Consulter pour option ignifuge. Usage intérieur et extérieur.

Units STD	Packaging Dimensions (cm)	m3/ pack	NW Unit (kg)	Units Container 20'	Units Container 40'	Units Container HC	Units Trayler (70m3)	Units Truck 100m3
2	245x80x47	-	43	2	8	-	16	16

**W** 242 x **L** 84 x **H** 45 cm  
**W** 95-1/4 x **L** 33-1/16 x **H** 17-11/16 in



Gris  
Grey  
Gris



Rojo  
Red  
Rouge



Blanco  
White  
Blanc

**W:** ancho / width / largeur **L:** largo / length / longueur **H:** altura / height / hauteur







banco / bench / banc

# Vela

DESIGNED BY ALDA Y JOVER

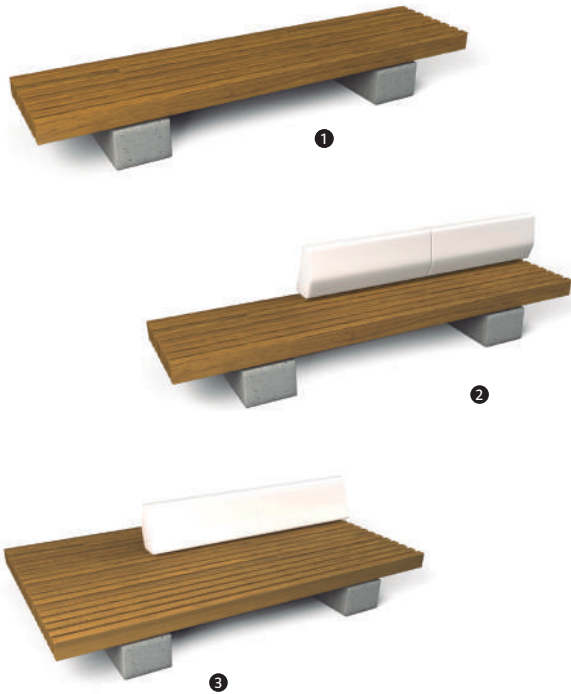

Pies en hormigón, asiento en madera de pino tratada y respaldo en polietileno rotacional. Estructura interior en acero inoxidable. Uso exterior.

Concrete legs, autoclave treated pine wood seat and back rest in rotational polyethylene. Interior structure in stainless steel. Outdoor use.

Piètement en béton, assise en bois de pin traité et dossier en polyéthylène rotomoulé. Structure intérieure en acier inoxydable. Usage extérieur.

Ref.	Units STD	Packaging Dimensions (cm)	m3/ pack	NW Unit (kg)	Units Container 20'	Units Container 40'	Units Container HC	Units Traylor (70m3)	Units Truck 100m3
VELA-01	2	350x75x44	-	520	4	12	-	18	24
VELA-02	2	350x75x100	-	535	4	12	-	18	24
VELA-03	1	350x200x100	-	1070	2	6	-	9	12

## 1 VELA-01

Bancada  
Bench  
Banquette

**W** 350 x **L** 73,5 x **H** 44 cm

**W** 137-13/16 x **L** 28-15/16 x **H** 17-5/16 in

## 3 VELA-03

Bancada con respaldo  
Backrest bench  
Banc à dossier

**W** 350 x **L** 200 x **H** 89,7 cm

**W** 137-13/16 x **L** 78-3/4 x **H** 35-5/16 in

## 2 VELA-02

Bancada con respaldo  
Backrest bench  
Banc à dossier

**W** 350 x **L** 73,5 x **H** 89,7 cm

**W** 137-13/16 x **L** 28-15/16 x **H** 35-5/16 in



Blanco  
White  
Blanc



Madera  
Wood  
Bois

banco / bench / banc

# Cetrus

DESIGNED BY SERGI FERNÁNDEZ



1



2

Estructura en acero pintado y asiento y respaldo en madera tropical. Opcionalmente en madera técnica WPC. Uso exterior.

Painted steel structure with seat and back rest in tropical wood. Optionally, could be done with technical wood WPC. Outdoor use.

Structure en acier peint. Assise et dossier en bois tropical. En option, bois technique WPC. Usage extérieur.

Ref.	Units STD	Packaging Dimensions (cm)	m3/ pack	NW Unit (kg)	Units Container 20'	Units Container 40'	Units Container HC	Units Traylor (70m3)	Units Truck 100m3
CETRUS-01	4	170x37x12 / 147x16x9	0,397	42,5	20	48	-	52	64
CETRUS-02	4	170x37x12 / 147x16x9	0,603	36,5	20	48	-	52	64
CETRUS-03	8	170x37x12 / 68x17x70	0,435	34	40	96	-	104	128
CETRUS-04	8	155x37x12 / 68x17x70	-	35	40	96	-	104	128
CETRUS-05	5	147x16x90	-	28	55	125	-	165	190

## CETRUS-01

Banco con respaldo  
Backrest bench  
Banc avec dossier

**W** 192,8 x **L** 61 x **H** 81,9 cm

**W** 75-7/8 x **L** 24 x **H** 30-13/16 in

## CETRUS-04

Bancada  
Bench  
Banquette

**W** 150 x **L** 61 x **H** 46 cm

**W** 70-7/8 x **L** 24 x **H** 18-1/8 in

## 1 CETRUS-02

Banco con respaldo  
Backrest bench  
Banc avec dossier

**W** 162,8 x **L** 61 x **H** 81,9 cm

**W** 64-1/8 x **L** 24 x **H** 30-13/16 in

## 2 CETRUS-05

Asiento individual  
Individual seat  
Siège individuel

**W** 72 x **L** 61 x **H** 81,9 cm

**W** 28-3/8 x **L** 24 x **H** 30-13/16 in

## CETRUS-03

Banco con respaldo  
Backrest bench  
Banc avec dossier

**W** 180 x **L** 61 x **H** 46 cm

**W** 70-7/8 x **L** 24 x **H** 18-1/8 in



Ral 9006/Madera  
Ral 9006/Wood  
Ral 9006/Bois





banco / bench / banc

# Norma

DESIGNED BY SERGI FERNÁNDEZ



Pies en fundición de aluminio y asiento y respaldo en madera tropical. Opcionalmente en madera técnica WPC. Uso exterior.

Aluminium casted legs with back rest and seat in tropical wood. Optionally, could be done with technical wood WPC. Outdoor use.

Piètement en fonte d'aluminium. Assise et dossier en tropical. En option, bois technique WPC. Usage extérieur.

Ref.	Units STD	Packaging Dimensions (cm)	m3/ pack	NW Unit (kg)	Units Container 20'	Units Container 40'	Units Container HC	Units Traylor (70m3)	Units Truck 100m3
NORMA-01	4	170x37x12 / 147x16x9	0,737	53	20	48	-	52	64
NORMA-02	4	170x37x12 / 147x16x9	0,737	45,5	20	48	-	52	64
NORMA-03	5	147x16x9	0,373	25	55	125	-	165	190

## NORMA-01

Banco  
Backrest bench  
Banc

**W** 180 x **L** 68 x **H** 85,4 cm

**W** 70-7/8 x **L** 26-3/4 x **H** 33-5/8 in

## 1 NORMA-02

Banco  
Backrest bench  
Banc

**W** 150 x **L** 68 x **H** 85,4 cm

**W** 59-1/16 x **L** 26-3/4 x **H** 33-5/8 in

## 2 NORMA-03

Asiento individual  
Individual seat  
Siège individuel

**W** 60 x **L** 68 x **H** 85,4 cm

**W** 23-5/8 x **L** 26-3/4 x **H** 33-5/8 in



Ral 9006/Madera

Ral 9006/Wood

Ral 9006/Bois

banco / bench / banc

# Nilo

DESIGNED BY VICENTE SOTO



Soportes en acero inoxidable. Asiento en madera tropical o polietileno. Uso exterior.

Stainless steel poles with tropical wood or polyethylene seats. Outdoor use.

Support en acier inoxydable. Assise en bois tropical ou polyéthylène. Usage extérieur.

Ref.	Units STD	Packaging Dimensions (cm)	m3/ pack	NW Unit (kg)	Units Container 20'	Units Container 40'	Units Container HC	Units Traylor (70m3)	Units Truck 100m3
NILO-01	2	220x80x120	-	75	14	30	-	36	42
NILO-02	2	220x80x145	-	80	14	30	-	36	42
NILO-11	2	220x100x120	-	66	10	24	-	26	32
NILO-22	2	220x100x145	-	70	10	24	-	26	32

## 1 NILO-01

Bancada  
Bench  
Banquette

**W** 200 x **L** 70 x **H** 41 cm

**W** 78-3/4 x **L** 27-9/16 x **H** 16-1/8 in

## 2 NILO-02

Banco  
Backrest bench  
Banc

**W** 200 x **L** 70 x **H** 65 cm

**W** 78-3/4 x **L** 27-9/16 x **H** 25-9/16 in

## 3 NILO-11

Bancada curva  
Curve bench  
Banc courbé

**W** 200 x **L** 87,4 x **H** 41 cm

**W** 78-3/4 x **L** 34-7/16 x **H** 16-1/8 in

## 4 NILO-22

Banco curvo  
Backrest curve bench  
Banc courbé avec dossier

**W** 200 x **L** 87,4 x **H** 65 cm

**W** 78-3/4 x **L** 34-7/16 x **H** 25-9/16 in



Inox brillante/Polietileno natural

Shiny Inox/Natural polyethylene

Inox Brillant/Polyéthylène naturel



Inox brillante/Madera

Shiny Inox/Wood

Inox Brillant/Bois



banco / bench / banc

# City

DESIGNED BY VICENTE SOTO



Estructura en chapa de acero pintada. Respaldo opcional en tubo de acero inoxidable. Asientos opcionales en madera laminada. Uso interior y exterior.

Painted steel plate structure. Optional: stainless steel tube back rest and laminated wood seats. Indoor and outdoor use.

Structure en planche d'acier peint. Dossier option en tube d'acier inoxydable. Option: assises en bois laminé. Usage intérieur et extérieur.

Ref.	Units STD	Packaging Dimensions (cm)	m3/ pack	NW Unit (kg)	Units Container 20'	Units Container 40'	Units Container HC	Units Trayler (70m3)	Units Truck 100m3
CITY-01 P	2	250x49x45	-	75	4	8	-	20	24
CITY-02 P	2	250x49x45	-	73	4	8	-	20	24
CITY-11 P	1	250x100x45	-	83	2	4	-	10	12
CITY-22 P	1	250x100x45	-	80	2	4	-	10	12
CITY-01 F	2	250x49x45	-	84,5	4	8	-	20	24
CITY-02 F	2	250x49x45	-	80	4	8	-	20	24
CITY-11 F	2	250x100x45	-	94	2	4	-	10	12
CITY-22 F	2	250x100x45	-	90	2	4	-	10	12

## CITY-01

Bancada recta  
Straight bench  
Banc droit

W 251 x L 49 x H 44,5 cm

W 98-13/16 x L 19-5/16 x H 17-1/2 in

## CITY-02

Bancada recta con jardinera  
Straight bench with flowerpot  
Banc droit avec jardinière

W 251 x L 49 x H 44,5 cm

W 98-13/16 x L 19-5/16 x H 17-1/2 in

## CITY-11

Bancada curvo  
Curve bench  
Banc courbé

W 239,2 x L 83,6 x H 44,5 cm

W 94-3/16 x L 32-15/16 x H 17-1/2 in



Negro  
Black  
Noir



Blanco  
White  
Blanc



Madera/Blanco  
Wood/White  
Bois/Blanc



Madera/Negro  
Wood/Black  
Bois/Noir

## CITY-22

Bancada curva con jardinera  
Curve bench with flowerpot  
Banc courbé avec jardinière

W 239,2 x L 83,6 x H 44,5 cm

W 94-3/16 x L 32-15/16 x H 17-1/2 in

## CITY-91

Respaldo recto  
Straight backrest  
Dossier droit

W 190,4 x L 5 x H 28 cm

W 74-15/16 x L 1-15/16 x H 11 in

## CITY-92

Respaldo curvo  
Curve backrest  
Dossier courbé

W 156,9 x L 54,3 x H 26 cm

W 1-15/16 x L 21-3/8 x H 10-1/4 in

banco / bench / banc

# Disk

DESIGNED BY JAVIER CUÑADO

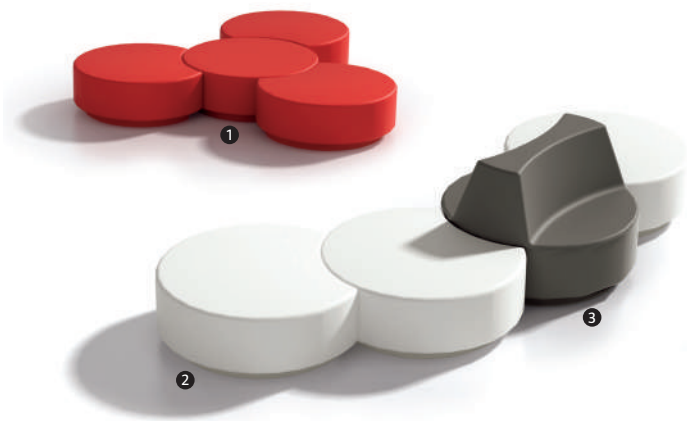

Banco en fibra de vidrio con resina de poliéster no saturado. Opción ignífuga consultar. Uso interior y exterior.

Non swamped polyester gum fiber glass bench. Optional: Fire-retardant version. Indoor and outdoor use.

Banc en fibre de verre et résine de polyester non saturé. Consulter pour option ignifuge. Usage intérieur et extérieur.

Ref.	Units STD	Packaging Dimensions (cm)	m3/ pack	NW Unit (kg)	Units Container 20'	Units Container 40'	Units Container HC	Units Trayler (70m3)	Units Truck 100m3
DISK-1	2	140x140x50	-	58	8	16	-	18	20
DISK-2	2	140x140x50	-	56	8	16	-	18	20
DISK-3	2	140x140x50	-	54	8	16	-	18	20
DISK-4	1	140x140x100	-	71	4	8	-	9	10
DISK-5	1	140x140x100	-	71	4	8	-	9	10
DISK-6	2	140x140x50	-	55	8	16	-	18	20

## 1 DISK-1

Bancada básica  
Bench  
Banquette

∅ 135 x H 50 cm

∅ 53-1/8 x H 19-11/16 in

## 2 DISK-2

Bancada media luna  
Half moon shape bench  
Banquette demi-lune

∅ 135 x H 50 cm

∅ 53-1/8 x H 19-11/16 in

## DISK-3

Bancada doble media luna  
Double half moon shape bench  
Banquette double demi-lune

∅ 135 x H 50 cm

∅ 53-1/8 x H 19-11/16 in

## 3 DISK-4

Banco básico respaldo recto  
Straight backrest bench  
Banc avec dossier droit

∅ 135 x H 95 cm

∅ 53-1/8 x H 37-3/8 in

## DISK-5

Banco básico respaldo curvo  
Curve backrest bench  
Banc avec dossier courbé

∅ 135 x H 95 cm

∅ 53-1/8 x H 37-3/8 in

## DISK-6

Bancada triple media luna  
Half moon shape triple bench  
Banquette triple demi-lune

∅ 135 x H 50 cm

∅ 53-1/8 x H 19-11/16 in



Gris  
Grey  
Gris



Rojo  
Red  
Rouge



Blanco  
White  
Blanc

∅: diámetro / diameter / diamètre W: ancho / width / largeur L: largo / length / longueur H: altura / height / hauteur



jardineras / flower pot / jardinière

# Meeting point

DESIGNED BY VICENTE SOTO



Jardinera en fibra de vidrio con resina de poliéster no saturado. Opción ignífuga consultar. Uso interior y exterior.

Non swamped polyester gum fiber glass flower pot. Optional: Fire-retardant version. Indoor and outdoor use.

Jardinière en fibre de verre avec résine de polyester non saturé. Consulter pour option ignifuge. sage intérieur et extérieur.

Ref.	Units STD	Packaging Dimensions (cm)	m3/ pack	NW Unit (kg)	Units Container 20'	Units Container 40'	Units Container HC	Units Trayler (70m3)	Units Truck 100m3
MEETING POINT	4	80x80x69,5	-	30	8	16	-	18	20

## 1 MEETING POINT-1

Jardinera agujero central  
Flowerpot with central hole  
Jardinière bac central

**W** 80 x **L** 80 x **H** 69,5 cm

**W** 31-1/2 x **L** 31-1/2 x **H** 27-3/8 in

## 2 MEETING POINT-2

Jardinera agujero lateral  
Flowerpot with side hole  
Jardinière bac latéral

**W** 80 x **L** 80 x **H** 69,5 cm

**W** 31-1/2 x **L** 31-1/2 x **H** 27-3/8 in



Blanco  
White  
Blanc

jardineras / flower pot / jardinière

# Mall

DESIGNED BY B+R ARQUITECTOS ASOCIADOS



Jardinera en acero pintado. Interior estanco. Color personalizable. Uso interior y exterior.

Painted steel flower pot. Watertight interior. Indoor and outdoor use. Customizable color.

Jardinière en acier peint. Intérieur étanche. Usage intérieur et extérieur. Couleur personnalisable.

Ref.	Units STD	Packaging Dimensions (cm)	m3/ pack	NW Unit (kg)	Units Container 20'	Units Container 40'	Units Container HC	Units Trayler (70m3)	Units Truck 100m3
MALL-02	2	120x120x86	-	50	8	20	-	44	48
MALL-03	2	120x120x50	-	39	8	20	-	44	52
MALL-10	1	90x90x120	-	35	10	22	-	26	30
MALL-12	2	90x90x65	-	27	20	44	-	52	60
MALL-20	2	60x60x110	-	20	22	50	-	66	76
MALL-21	2	60x60x80	-	17	22	50	-	66	76

## MALL-02

Jardinera  
Flowerpot  
Jardinière

**φ** 120 x **H** 86 cm

**φ** 47-1/4 x **H** 33-7/8 in

## 1 MALL-03

Jardinera  
Flowerpot  
Jardinière

**φ** 120 x **H** 45,5 cm

**φ** 47-1/4 x **H** 17-15/16 in

## 2 MALL-10

Jardinera  
Flowerpot  
Jardinière

**φ** 85 x **H** 118 cm

**φ** 33-7/16 x **H** 46-7/16 in

## MALL-12

Jardinera  
Flowerpot  
Jardinière

**φ** 85 x **H** 64 cm

**φ** 33-7/16 x **H** 25-3/16 in

## MALL-20

Jardinera  
Flowerpot  
Jardinière

**φ** 55 x **H** 101 cm

**φ** 21-5/8 x **H** 39-3/4 in

## MALL-21

Jardinera  
Flowerpot  
Jardinière

**φ** 55 x **H** 75 cm

**φ** 21-5/8 x **H** 29-1/2 in



Blanco  
White  
Blanc



Marrón  
Brown  
Brun

jardineras / flower pot / jardinière

# Berta

DESIGNED BY FRANC FERNÁNDEZ / KX DESIGNERS



Cuerpo en plancha aluminio. Cubeta interior en polietileno. Pintado interior a petición cliente. Tapas laterales en acero pintado. Uso interior y exterior. Uso interior y exterior.

Body made of aluminium with a plastic liner. Lateral lids are in painted steel. As an option the interior part could be painted. Indoor and outdoor use.

Corps en tôle d'aluminium. Corbeille intérieure en polyéthylène. Sur demande, possibilité de peinture intérieure. Extrémités en acier peint. Usage intérieur et extérieur.

Ref.	Units STD	Packaging Dimensions (cm)	m3/ pack	NW Unit (kg)	Units Container 20'	Units Container 40'	Units Container HC	Units Trayler (70m3)	Units Truck 100m3
BERTA-10	3	119x79x57	0,517	35	33	75	-	99	114

## BERTA-10

Jardineras con maceta interior  
Flower pot with internal liner  
Jardinière avec pot intérieur

**W** 100 x **L** 78 x **H** 45 cm

**W** 39-3/8 x **L** 30-11/16 x **H** 17-3/4 in



Aluminio  
Aluminium  
Aluminium

jardineras / flower pot / jardinière

# Scoop

DESIGNED BY JULIE STORM



Polietileno rotacional proyección UV. Sistema de autoriego.

Rotational polyethylene protected against UV radiation. Self watering system. Indoor and outdoor use.

Polyéthylène rotomoulé. Résistance aux U.V. Système d'auto arrosage. Usage intérieur et extérieur.

Ref.	Units STD	Packaging Dimensions (cm)	m3/ pack	NW Unit (kg)	Units Container 20'	Units Container 40'	Units Container HC	Units Trayler (70m3)	Units Truck 100m3
SCOOP-01	2	105x67x104	0,187	30	20	44	-	52	60

## SCOOP-01

Jardineras  
Flowerpot  
Jardinière

**Cap.** 65 L **ø** 97 x **H** 63,5 cm

**Cap.** 17.2 gal. **ø** 38-3/16 x **H** 25 in



Verde lima  
Lime green  
Vert lime



Naranja  
Orange  
Orange

jardineras / flower pot / jardinière

# Rail

DESIGNED BY JOAN GASPAR



Contenedores modulares fabricados en perfil de aluminio. Niveladores en nylon. Soporte en U en letina de acero pintada. Mesa auxiliar en compacto laminado. Uso interior y exterior.

Aluminium profile containers. Nylon levellers or U-shaped support in painted steel. As an option, we can provide an auxiliary table made of laminated compact material. Indoor and outdoor use.

Bacs modulables en profilé d'aluminium. Pieds de nivellement. Support en forme de U en acier plat peint. Table auxiliaire en compact laminé. Usage intérieur et extérieur.

Ref.	Units STD	Packaging Dimensions (cm)	m3/ pack	NW Unit (kg)	Units Container 20'	Units Container 40'	Units Container HC	Units Trayler (70m3)	Units Truck 100m3
RAIL-01	8	104x60x55	-	25	88	200	-	264	304
RAIL-02	1	155x60x55	-	32	10	24	-	26	30
RAIL-03	1	200x60x55	-	39	10	24	-	26	30
RAIL-04	1	250x60x55	-	54	10	24	-	26	30
RAIL-05	1	300x60x55	-	70	10	24	-	26	30
RAIL-101		100x50x50	-	22	0	0	-	0	0
RAIL-102		145x50x50	-	29	0	0	-	0	0
RAIL-103	1	170x50x50	-	36	10	24	-	26	30
RAIL-104		225x50x50	-	51	10	0	-	0	0
RAIL-105		250x50x50	-	66	10	0	-	0	0
RAIL-40	40	45x12x60	-	5	440	1000	-	1320	1520
RAIL-80	8	54x39x82	-	8	88	200	-	264	304
RAIL-81	8	54x39x82	-	8	88	200	-	264	304
RAIL-82	8	90x35x25	-	6	10	192	-	208	240

## RAIL-01

Jardinera con soporte en U  
Flowerbed with U-shaped support  
Jardinière avec support en U

**W** 100 x **L** 54 x **H** 47,3 cm

**W** 39-3/8 x **L** 21-1/4 x **H** 18-5/8 in

## RAIL-02

Jardinera con soporte en U y accesorio opcional  
Flowerbed with U-shaped support and optional accessory  
Jardinière avec support en U et accessoire en option

**W** 150 x **L** 54 x **H** 47,3 cm

**W** 59-1/16 x **L** 21-1/4 x **H** 18-5/8 in

## RAIL-03

Jardinera con soporte en U  
Flowerbed with U-shaped support  
Jardinière avec support en U

**W** 191 x **L** 54 x **H** 47,3 cm

**W** 75-3/16 x **L** 21-1/4 x **H** 18-5/8 in

## RAIL-04

Jardinera con soporte en U y accesorio opcional  
Flowerbed with U-shaped support and optional accessory  
Jardinière avec support en U et accessoire en option

**W** 242 x **L** 54 x **H** 47,3 cm

**W** 95-1/4 x **L** 21-1/4 x **H** 18-5/8 in

## RAIL-05

Jardinera con soporte en U  
Flowerbed with U-shaped support  
Jardinière avec support en U

**W** 282 x **L** 54 x **H** 47,3 cm

**W** 111 x **L** 21-1/4 x **H** 18-5/8 in

## RAIL-80

Maceta para jardinera con niveladores  
Flowerpot for flowerbed with levellers  
Pot de fleurs pour jardinière avec pieds de nivellement

**W** 74,2 x **L** 34,7 x **H** 39,5 cm

**W** 29-3/16 x **L** 13-11/16 x **H** 15-9/16 in

## RAIL-82

Maceta para jardinera con soporte en U  
Flowerpot for flowerbed with U-shaped support  
Pot de fleurs pour jardinière avec support en U

**W** 90 x **L** 35 x **H** 23 cm

**W** 35-7/16 x **L** 13-3/4 x **H** 9-1/16 in

## 1 RAIL-101

Jardinera con niveladores  
Flowerbed with levellers  
Jardinière avec pieds de nivellement

**W** 90 x **L** 45,2 x **H** 46,5 cm

**W** 35-7/16 x **L** 17-13/16 x **H** 18-5/16 in

## RAIL-102

Jardinera con niveladores y accesorio opcional  
Flowerbed with levellers and optional accessory  
Jardinière avec pieds de nivellement et accessoire en option

**W** 140 x **L** 45,2 x **H** 46,5 cm

**W** 55-1/8 x **L** 17-13/16 x **H** 18-5/16 in

## RAIL-103

Jardinera con niveladores  
Flowerbed with levellers  
Jardinière avec pieds de nivellement

**W** 168 x **L** 45,2 x **H** 46,5 cm

**W** 66-2/16 x **L** 17-13/16 x **H** 18-5/16 in

## RAIL-104

Jardinera con niveladores y accesorio opcional  
Flowerbed with levellers and optional accessory  
Jardinière avec pieds de nivellement et accessoire en option

**W** 218 x **L** 45,2 x **H** 46,5 cm

**W** 85-13/16 x **L** 17-13/16 x **H** 18-5/16 in

## RAIL-105

Jardinera con niveladores  
Flowerbed with levellers  
Jardinière avec pieds de nivellement

**W** 246 x **L** 45,2 x **H** 46,5 cm

**W** 96-7/8 x **L** 17-13/16 x **H** 18-5/16 in



Aluminio/Blanco  
Aluminium/ White  
Aluminium/ Blanc





señalética / signage / signalétique

# Roomie

DESIGNED BY LEDS-C4



Aplique pared en aluminio. Filtros incluidos. Uso interior.

Aluminium wall bracket lighting fixture. Filters included. Indoor use.

Applique murale en aluminium. Filtrés inclus. Usage intérieur.

Units Ref.	STD	Packaging Dimensions (cm)	m3/ pack	NW Unit (kg)	Units Container 20'	Units Container 40'	Units Container HC	Units Traylor (70m3)	Units Truck 100m3
ROOMIE	384	14,5x15x85	-	1	4.224	9.600	-	12.672	14.592

**ROOMIE**  
Señalética  
Signalling elements  
Signalétique

∅: 12 x H 5,8 cm  
∅: 4-3/4 x H 2-5/16 in  
100-240 V / 50-60 Hz



Aluminio/Blanco  
Aluminium/ White  
Aluminium/ Blanc

∅: diámetro / diameter / diamètre    **W:** ancho / width / largeur    **L:** largo / length / longueur    **H:** altura / height / hauteur



# Index

DESIGNED BY VICENT MARTÍNEZ



Rótulos troquelados en acero inoxidable. Carpetas: metacrilato con embellecedor en acero inoxidable. Disponible con inscripción en Braille. Uso interior.

Die cut sign plates in stainless steel. Folders are made of methacrylate with stainless steel trim. Available with printing in Braille. Indoor use.

Panneaux découpés en acier inoxydable. Porte-affiches en méthacrylate avec finition en acier inoxydable. Disponible avec une inscription en braille. Usage intérieur.

	Units Ref.	Units STD	Packaging Dimensions (cm)	m3/ pack	NW Unit (kg)	Units Container 20'	Units Container 40'	Units Container HC	Units Traylor (70m3)	Units Truck 100m3
INDEX-01	405		16,5x9x3,5	0	1	4.455	10.125	10.125	13.365	15.390
INDEX-02	405		16,5x9x3,5	0	1	4.455	10.125	10.125	13.365	15.390
INDEX-03	405		16,5x9x3,5	0	1	4.455	10.125	10.125	13.365	15.390
INDEX-04	405		16,5x9x3,5	0	1	4.455	10.125	10.125	13.365	15.390
INDEX-05	405		16,5x9x3,5	0	1	4.455	10.125	10.125	13.365	15.390
INDEX-06	405		16,5x9x3,5	0	1	4.455	10.125	10.125	13.365	15.390
INDEX-07	405		16,5x9x3,5	0	1	4.455	10.125	10.125	13.365	15.390
INDEX-11	400		22x13x10	0	1	4.000	10.000	10.000	13.200	15.200
INDEX-12	400		25x18x20	0	1	4.000	10.000	10.000	13.200	15.200
INDEX-13	240		22x18x20	0,001	1	2.640	6.000	6.000	7.920	9.120
INDEX-14	240		25x21x10	0,001	1	2.640	6.000	6.000	7.920	9.120
INDEX-15	240		30x24x10	0,001	1	2.640	6.000	6.000	7.920	9.120
INDEX-16	240		33x22x10	0,001	1	2.640	6.000	6.000	7.920	9.120
INDEX-20	400		26x14x10	0,002	1	4.400	10.000	10.000	13.200	15.200
INDEX-31	240		23x22x10	0,001	1	2.640	6.000	6.000	7.920	9.120
INDEX-32	400		21x18x10	0	1	4.400	10.000	10.000	13.200	15.200
INDEX-54	40		44x33x10	0,001	1	440	1.000	1.000	1.320	1.520

## 1 INDEX-01/02/03/04/05/06/07/08

Placa baño hombre, mujer, minusválido, office, guardarropía, privado, director, numeración  
Toilet plate gentlemen, ladies, handicapped, lunch room, wardrobe, private, director, numbers  
Plaques : toilettes pour hommes, femmes ou personnes handicapées, bureau, vestiaire, espace privé, direction, numérotation

W 7,55 x L 8 x H 15,5 cm

W 3 x L 5/16 x H 6-1/8 in

## INDEX-11

Señalética mural  
Signalling wall device  
Panneau signalétique mural

W 21 x L 1,2 x H 12,45 cm

W 8-1/4 x L 1/2 x H 5-1/8 in

## INDEX-12

Señalética mural DINAS vertical  
Signalling wall device DINAS portrait  
Panneau signalétique mural de format A5 vertical

W 14,85 x L 1,2 x H 23,45 cm

W 5-14/16 x L 1/2 x H 9-4/16 in

## 2 INDEX-13

Señalética mural DINAS horizontal  
Signalling wall device DINAS landscape  
Panneau signalétique mural de format A5 horizontal

W 21 x L 1,2 x H 17,3 cm

W 8-1/4 x L 1/2 x H 6-13/16 in

## INDEX-14

Señalética mural  
Signalling wall device  
Panneau signalétique mural

W 21 x L 1,2 x H 23,95 cm

W 8-1/4 x L 1/2 x H 9-7/16 in

## INDEX-15

Señalética mural DINAS horizontal  
Signalling wall device DINAS landscape  
Panneau signalétique mural de format A4 horizontal

W 29,7 x L 1,2 x H 24 cm

W 11-11/16 x L 1/2 x H 9-7/16 in

## INDEX-16

Señalética mural DINAS vertical  
Signalling wall device DINAS portrait  
Panneau signalétique mural de format A4 vertical

W 21 x L 1,2 x H 23,7 cm

W 8-1/4 x L 1/2 x H 12-7/8 in

## INDEX-17

Señalética mural DINAS horizontal  
Signalling wall device DINAS landscape  
Panneau signalétique mural de format A3 horizontal

W 42 x L 1,2 x H 33,2 cm

W 8-1/4 x L 1/2 x H 13-1/16 in

## INDEX-20

Señalética sobremesa  
Tabletop signalling device  
Panneau signalétique de bureau

W 21 x L 12,45 x H 5,9 cm

W 8-1/4 x L 4-15/16 x H 2-5/16 in

## INDEX-30

Señalética banderola DINAS vertical  
Signalling device DINAS portrait flag-type  
Panneau signalétique en drapeau de format A4 vertical

W 23,45 x L 2,75 x H 30 cm

W 9-1/4 x L 1-1/16 x H 11-13/16 in

## INDEX-31

Señalética banderola  
Signalling device flag-type  
Panneau signalétique en drapeau

W 23,45 x L 2,75 x H 21,3 cm

W 9-1/4 x L 1-1/16 x H 8-3/8 in

## INDEX-32

Señalética banderola DINAS vertical  
Signalling device DINAS portrait flag-type  
Panneau signalétique en drapeau de format A5 vertical

W 17,3 x L 2,75 x H 21,3 cm

W 6-13/16 x L 1-1/16 x H 8-3/8 in

## INDEX-54

Señalética aerea DINAS horizontal  
Hanging signalling device DINAS landscape  
Panneau signalétique suspendu de format A3 horizontal

W 42 x L 1 x H 32,5 cm

W 16-9/16 x L 3/8 x H 12-13/16 in

## INDEX-55

Señalética aerea DINAS horizontal  
Hanging signalling device DINAS landscape  
Panneau signalétique suspendu de format A4 horizontal

W 29,7 x L 1 x H 23,8 cm

W 11-11/16 x L 3/8 x H 9-3/8 in



Inox satinado/Transparente  
Satin Inox/Transparent  
Inox satin/Transparent



señalética / signage / signalétique

# Index

DESIGNED BY VICENT MARTÍNEZ



Base: Fundición de hierro con embellecedor en acero inoxidable. Poste: acero inoxidable. Cuerda: 3 colores. Uso interior.

Cast iron base with stainless steel trim. Pole also in stainless steel. The band could be in 3 different colours. Indoor use.

Base: fonte de fer avec finition en acier inoxydable. Poteau: acier inoxydable. Corde: 3 coloris. Usage intérieur.

Units Ref.	STD	Packaging Dimensions (cm)	m3/ pack	NW Unit (kg)	Units Container 20'	Units Container 40'	Units Container HC	Units Trayler (70m3)	Units Truck 100m3
INDEX-64	6	38x330x152	0,148	10	66	150	-	198	228
INDEX-65	6	38x330x152	0,191	12	66	150	-	198	228
INDEX-80	10	38x33x108	0,127	11	110	250	-	330	380

## 1 INDEX-64/65

Señalética de pie DINA4 horizontal  
Free standing signalling device DINA 4 landscape  
Signalétique sur pied A4 horizontal

W 29,7 x L 27 x H 112,5 | 150 cm  
W 11-11/16 x L 10-5/8 x H 44-5/16 | 59-1/16 in

## 2 INDEX-80

Poste direccionador de filas  
Queue barrier pole  
Poteau de marquage pour files d'attente

ø 27 x H 92,7 cm  
ø 10-5/8 x H 36-5/16 in

## 3 INDEX-85

Cuerda  
Rope  
Corde

ø 2,2 x H 200 cm  
ø 7/8 x H 78-3/4 in



Inox satinado/Negro  
Satin Inox/Black  
Inox satin/Noir



Inox satinado/Rojo  
Satin Inox/Red  
Inox satin/Rouge



Inox satinado/Azul  
Satin Inox/Blue  
Inox satin/Bleu

## 4 INDEX-81

Aro porta cable para Index-64 y 65  
Rope ring for Index-64 and 65  
Anneau porte cable pour Index 64 et 65

ø 4,5 x H 0,3 cm  
ø 1-3/4 x H 2/16 in

## 5 INDEX-82

Fijación mural  
Wall fixer  
Fixation murale

W 4,5 x L 2,4 x H 2,4 cm  
W 1-3/4 x L 15/16 x H 15/16 in

señalética / signage / signalétique

# Cua

DESIGNED BY I+D VILAGRASA



Base: Poliuretano o acero inoxidable. Poste: acero inoxidable. Cinta: 4 colores. Uso interior.

Stainless steel or polyurethane base with stainless steel pole. The band can be in 4 different colours. Indoor use.

Base : polyuréthane ou acier inoxydable. Poteau: acier inoxydable. Sangle : 4 coloris. Usage intérieur.

Units Ref.	STD	Packaging Dimensions (cm)	m3/ pack	NW Unit (kg)	Units Container 20'	Units Container 40'	Units Container HC	Units Trayler (70m3)	Units Truck 100m3
CUA-01	10	36x36x108	0,133	11	110	250	-	330	380
CUA-02	5.000	15x3x1	0	1	55.000	125.000	-	165.000	190.000
CUA-04	150	47x23x10	0,011	2	1.650	3.750	-	4.950	5.700
CUA-05	10	36x36x108	0,133	16	110	250	-	330	380

## CUA-01/ CUA-05

Poste direccionador de filas  
Queue barrier pole  
Poteau de marquage pour files d'attente

ø: 31,5 x H 90,5 cm  
ø: 12-3/8 x H 35-5/8 in

## CUA-02

Fijación mural  
Wall fixer  
Fixation murale



Inox brillante/Negro  
Shiny Inox/Black  
Inox brillant/Noir



Inox br./Rojo/Negro  
Sh. Inox/Red/Black  
Inox br./Rouge/Noir



Inox br./Azul/Negro  
Sh. Inox/Blue/Black  
Inox br./Bleu/Noir



Inox br./Verde/Negro  
Sh. Inox/Green/Black  
Inox br./Vert/Noir

## CUA-04

Porta-pancartas DIN A4  
Portrait A4 holder  
Porte-documents A4 vertical

W 21,5 x H 37,5 cm  
W 8-7/16 x H 14-6/8 in



señalética / signage / signalétique

## Bas 3001/02/03/04

DESIGNED BY BAS STUDIO

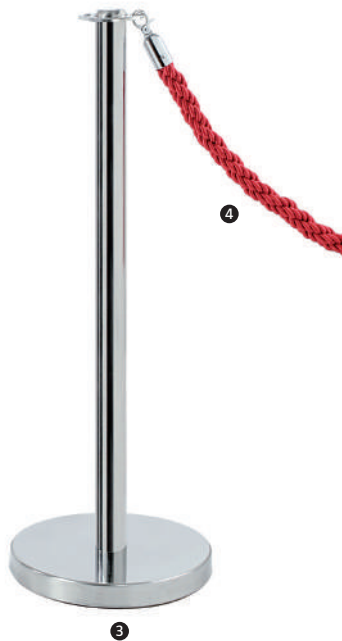

Bas 3001 y 3002 en acero pintado. Largos carro 2m. y 3m. respectivamente. Bas 3003 en acero inoxidable. Uso interior.

The references Bas 3001 and 3002 are made of painted steel. The band length is of 2 mts and 3 mts. The reference Bas 3003 is made of stainless steel. Indoor use.

Bas 3001 et 3002 en acier peint. Sangles longues 2m et 3m respectivement. Bas 3003 en acier inoxydable. Usage intérieur.

Ref.	Units STD	Packaging Dimensions (cm)	m3/ pack	NW Unit (kg)	Units Container 20'	Units Container 40'	Units Container HC	Units Trayler (70m3)	Units Truck 100m3
BAS-3001	48		-	18	528	1.200	-	1.584	1.824
BAS-3002	36		-	23	396	900	-	1.188	1.368
BAS-3003	30		-	88	330	750	-	990	1.140
BAS-3004	360		-	12	3.960	9.000	-	11.880	13.680

### 1 BAS-3001

∅ 30 x L 95 cm  
∅ 11-13/16 x L 37-7/16 in

### 2 BAS-3002

∅ 36 x ∅ 5,1 x L 104 cm  
∅ 11-13/16 x L 37-7/16 in

### 3 BAS-3003

∅ 32 x ∅ 5,1 x L 91 cm  
∅ 11-13/16 x L 37-7/16 in

### 4 BAS-3004

∅ 150 cm  
∅ 59-1/16 in



Inox brillante/Rojo  
Shiny Inox/Red  
Inox brillant/Rouge



Negro/Rojo  
Black/Red  
Noir/Rouge



Negro/Azul  
Black/Blue  
Noir/Bleu

atriles / lectern / lutrin

# Levo

DESIGNED BY MARIO RUIZ



Estructura, base metálica y pieza en fundición de aluminio en acero pintado. Sobre en compacto. Frontal en metacrilato

Structure and metallic base with cast aluminium painted steel piece. Top made in compact. Frontside in methacrylate.

Structure et base métallique avec pièce en fonte d'aluminium en acier peint. Plateau en stratifié compact. Frontal en méthacrylate.

Ref.	Units STD	Packaging Dimensions (cm)	m3/ pack	NW Unit (kg)	Units Container 20'	Units Container 40'	Units Container HC	Units Trayler (70m3)	Units Truck 100m3
LEVO-01	1	69x72x127	-	51	11	25	-	33	38
LEVO-02	1	69x72x127	-	51	11	25	-	33	38

## LEVO-01

Atril regulable en altura  
Lecture lectern with adjustable height  
Pupitre de conférence réglable en hauteur

**W** 59,6 x **L** 62 x **H** 65 | 102,5 cm  
**W** 23-7/16 x **L** 26 x **H** 40-3/8 | 52-3/16 in

## 1 LEVO-02

Atril fijo  
Fixed lecture lectern  
Pupitre de conférence fixe

**W** 59,6 x **L** 62 x **H** 102,5 cm  
**W** 23-7/16 x **L** 26 x **H** 49-1/4 in

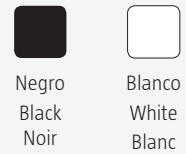

atriles / lectern / lutrin

# Arc

DESIGNED BY ANTONI FLORES



Sobre: espuma de poliuretano. Base: fundición metálica vulcanizada. Columna: aluminio extrusionado.

Top made of polyurethane foam. Vulcanized steel cast base. The pole is in extruded aluminium.

Plateau: mousse de polyuréthane. Base : fonte métallique avec caoutchouc vulcanisé. Colonne: aluminium extrudé.

Ref.	Units STD	Packaging Dimensions (cm)	m3/ pack	NW Unit (kg)	Units Container 20'	Units Container 40'	Units Container HC	Units Trayler (70m3)	Units Truck 100m3
ARC-20216	1	69x72x145	0,148	43	11	25	-	33	38
ARC-12216-H	1	69x72x145	0,191	45	11	25	-	33	38
ARC-220216-L	1	69x72x145	0,127	50	11	25	-	33	38

## ARC-20216

Atril 15° de inclinación fijo  
Fixed lectern 15 degrees inclined  
Pupitre de conférence fixe, incliné à 15°

**W** 65 x **L** 66 x **H** 112,8 cm  
**W** 25-9/16 x **L** 26 x **H** 44-7/16 in

## ARC-20216-HL

Atril 15° de inclinación regulable en altura con lámpara  
Height adjustable lectern 15 degrees inclined with lamp  
Pupitre de conférence à hauteur réglable avec lampe, incliné à 15°

**W** 65 x **L** 66 x **H** 114 | 144 cm  
**W** 25-9/16 x **L** 26 x **H** 44-14/16 | 56-11/16 in

## 1 ARC-1 20216-H

Atril 15° de inclinación regulable en altura  
Height adjustable lectern 15 degrees inclined  
Pupitre de conférence à hauteur réglable, incliné à 15°

**W** 65 x **L** 66 x **H** 114 | 144 cm  
**W** 25-9/16 x **L** 26 x **H** 44-14/16 | 56-11/16 in

## ARC-2 20216-L

Atril 15° de inclinación fijo con lámpara  
Fixed lectern 15 degrees inclined with lamp  
Pupitre de conférence fixe avec lampe, incliné à 15°

**W** 65 x **L** 66 x **H** 124 cm  
**W** 25-9/16 x **L** 26 x **H** 48-13/16 in

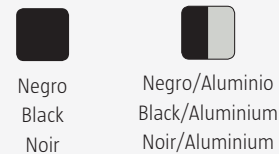



percheros / coat hangers / porte manteaux

# Fargo

DESIGNED BY PASCUAL SALVADOR



Base de fundición de hierro. Columna y barras en aluminio extrusionado. Brazos en fundición de aluminio. Colgador en ABS. Percha de poliuretano.

Cast steel base with pole and bars of extruded aluminium. The arms are made of cast aluminium and hooks in ABS. Polyurethane hangers.

Base en fonte de fer. Colonne et barres en aluminium extrudé. Bras en fonte d'aluminium. Crochet en ABS. Cintre en polyuréthane.

Ref.	Units STD	Packaging Dimensions (cm)	m3/ pack	NW Unit (kg)	Units Container 20'	Units Container 40'	Units Container HC	Units Trayler (70m3)	Units Truck 100m3
FM-1P	3	170x50x60	-	21	33	75	75	99	114
FP-2	10	170x38x13	-	36	110	250	250	330	380
FC-1	3	169x68x42	-	43	33	75	75	99	114
FC-2	3	169x68x42	-	45	33	75	75	99	114
FC-2P	3	169x68x42	-	62	33	75	75	99	114
FCP	16	169x40x15	-	27	176	400	400	528	608

### FC-1

Carro 1 brazo  
Trolley 1 arm  
Chariot 1 bras

**W** 161 x **L** 64 x **H** 174 cm

**W** 63-3/8 x **L** 25-3/16 x **H** 68-1/2 in

### 1 FC-1P

Carro 1 brazo con paraguero  
Trolley 1 arm with umbrella stand  
Chariot 1 bras avec porte-parapluie

**W** 161 x **L** 64 x **H** 174 cm

**W** 63-3/8 x **L** 25-3/16 x **H** 68-1/2 in

### 2 FC-2

Carro 2 brazos  
Trolley 2 arms  
Chariot 2 bras

**W** 163 x **L** 78 x **H** 179 cm

**W** 64-3/16 x **L** 30-11/16 x **H** 70-1/2 in

### 3 FC-2P

Carro 2 brazos con paraguero  
Trolley 2 arms with umbrella stand  
Chariot 2 bras avec porte-parapluies

**W** 163 x **L** 78 x **H** 179 cm

**W** 64-3/16 x **L** 30-11/16 x **H** 70-1/2 in

### FCP

Carro paraguero con ruedas  
Umbrella stand trolley with casters  
Porte-parapluies avec roulettes

**W** 126 x **L** 40 x **H** 58,5 cm

**W** 49-5/8 x **L** 15-3/4 x **H** 23-1/16 in

### FCPN

Carro paraguero con niveladores  
Umbrella stand trolley with levellers  
Porte-parapluies avec patins à réglage

**W** 126 x **L** 40 x **H** 58,5 cm

**W** 49-5/8 x **L** 15-3/4 x **H** 23-1/16 in



Negro  
Black  
Noir



Negro/Aluminio  
Black/Aluminium  
Noir/Aluminium

percheros / coat hangers / porte manteaux

## Bas 4500

DESIGNED BY BAS STUDIO



Estructura tubular en acero inoxidable.

Stainless steel tube.

Structure en acier inoxydable de section tubulaire.

Ref.	Units STD	Packaging Dimensions (cm)	m3/ pack	NW Unit (kg)	Units Container 20'	Units Container 40'	Units Container HC	Units Trayler (70m3)	Units Truck 100m3
BAS 4500	8	-	-	10	88	200	-	264	304

### BAS 4500

W 125 x L 55 x H 170 cm

W 49-1/4 x L 21-11/16 x H 66-15/16 in



Inox satinado

Satin Inox

Inox satin

percheros / coat hangers / porte manteaux

## Kit

DESIGNED BY NAHTRANG



Estructura y accesorios en acero pintado.

Painted steel structure and accessories.

Structure et accessoires en acier peint.

Ref.	Units STD	Packaging Dimensions (cm)	m3/ pack	NW Unit (kg)	Units Container 20'	Units Container 40'	Units Container HC	Units Trayler (70m3)	Units Truck 100m3
KIT-01	8	-	-	19	88	200	-	264	304

### 1 KIT-01

Carro 2 brazos  
Coat stand with casters and two top rods  
Porte-manteaux 2 bras

W 160 x L 55,5 x H 179,7 cm

W 62 x L 21-7/8 x H 70-3/4 in

### 2 KIT-02

Carro 1 brazo  
Coat stand with casters and one top rod  
Porte-manteaux 1 bras

W 160 x L 55,5 x H 178,8 cm

W 62 x L 21-7/8 x H 70-3/8 in

### 3 KIT-05

Bandeja Superior para KIT-01  
Top tray for KIT-01  
Plateau supérieur pour KIT-01

W 150 x L 54,3 x H 17,30 cm

W 59-1/16 x L 21-3/8 x H 68-1/8 in

### 4 KIT-06

Paragüero para KIT-01  
Umbrella accessory for KIT-01  
Porte-parapluies pour KIT-01

W 155,5 x L 32 x H 3 cm

W 61-1/4 x L 12-5/8 x H 1-3/16 in

### KIT-07

Paragüero pequeño para KIT-01  
Little umbrella accessory for KIT-01  
Petit porte-parapluies pour KIT-01

W 18,8 x L 16,3 x H 21,55 cm

W 7-3/8 x L 6-7/16 x H 8-1/2 in



Verde  
Green  
Vert



Blanco  
White  
Blanc



Las medidas y los pesos del catálogo son aproximados. RESOL se reserva el derecho de realizar los cambios oportunos sin previo aviso.  
Sizes and weights of the catalogue are approximate. RESOL reserves the rights of introducing any suitable alteration without notice.  
Les dimensions et les poids du catalogue sont approximatifs. RESOL se réserve le droit d'introduire les modifications nécessaires sans les notifier.





### **Agradecimientos / Acknowledgements/ Remerciements**

Pizzeria Boca-Pizza (Cizur Mayor), Universidad Central del Ecuador (Quito – Ecuador), Lalo Restaurant (Ostróda – Poland), American University (Blagoevgrad – Bulgaria), Restaurant La Quinta Justa (Olot), Engresca (Girona), Port Blau Lounge Bar (L’Estartit), El Cellar de Can Roca (Girona), Santorini Water Fantasy Park (Cha-am Petchburi – Thailand), Restaurant ATN (Barcelona), Llar d’Infants Municipal (Besalú), Restaurant Ca l’Enric (La Vall de Bianya), Hotel Meliá Varadero (Varadero – Cuba), @Sant Cugat Business Park (Sant Cugat), Hotel Resguard dels Vents (Ribes de Freser), Restaurant Es Boldadó (Eivissa), Hotel HM Gran Fiesta (Palma de Mallorca), Festival Afònica (Banyoles), Hospital Sant Pau (Barcelona), Piscina Municipal (Sant Esteve d’en Bas), Hotel Aquamarina (Santa Susanna), Camping Solmar (Blanes), Hotel Medplaya Riviera (Benalmádena), Centre de Convencions (Sabadell), Hotel-Spa Resguard dels Vents (Ribes de Freser), EMD École de Management (Marseille - France), Hotel Pestana Bogotá 100 (Bogotá - Colombia), CC Ágora (Santo Domingo - Rep. Dominicana), Centre Esportiu Illa Activa (Cabriels), Restaurante Ca Consuelo (L’Eliana), Col’caccio Restaurant (Cape Town - South Africa), The Xara Lodge (Rabat - Malta), Heladería Sirvent (Murcia), Hotel Monte Igueldo (San Sebastián), Col·legi d’interioristes i decoradors de Catalunya, Ajuntament Sant Cugat del Vallès, Hotel Sofia (Sitges), Ajuntament de Palma de Mallorca, NEORG Branding Partners (Girona), Estudi Gràfic (Girona), Alzamora Group (Girona) y al equipo de Resol.